

Panasonic®

Model No.

TH-42LFE7U
TH-42LFE7E
TH-50LFE7U
TH-50LFE7E
TH-65LFE7U
TH-65LFE7E
TH-42LFE7ER

Operating Instructions

FULL HD LCD Display (for business use)



HDMI

English

Please read these instructions before operating your set and retain them for future reference.

Dear Panasonic Customer

Welcome to the Panasonic family of customers. We hope that you will have many years of enjoyment from your new LCD Display.

To obtain maximum benefit from your set, please read these Instructions before making any adjustments, and retain them for future reference.

Retain your purchase receipt also, and note down the model number and serial number of your set in the space provided on the rear cover of these instructions.

Visit our Panasonic Web Site <http://panasonic.net>

Table of Contents

Before use

- Illustrations and screens in this Operating Instructions are images for illustration purposes, and may be different from the actual ones.
- Descriptive illustrations in this Operating Instructions are created mainly based on the 65 inch model.

Important Safety Instructions	1	ECO Mode settings	32
FCC STATEMENT	2	Customizing the Input labels	33
Important Safety Notice	3	Selecting the On-Screen Menu Language	34
Safety Precautions	4	Customizing the On-Screen Menu Display	34
Accessories	7	Setup for MULTI DISPLAY	35
Accessories Supply	7	How to Setup MULTI DISPLAY	35
Remote Control Batteries	7	ID Remote Control Function	36
Connections	8	Setup for Input Signals	37
AC cord connection	8	YUV / RGB-IN select	37
Video equipment connection	8	Signal menu	38
AUDIO OUT connection	9	Cinema reality	38
HDMI connection.....	9	XGA Mode	39
DVI-D IN connection.....	10	Sync	39
PC Input Terminals connection.....	11	HDMI Range.....	40
SERIAL Terminals connection	12	Input signal display	40
IR IN/OUT (infrared signal) connection	13	Network Setup	41
CHARGE Terminals connection	13	Options Adjustments	43
Power On / Off	14	Input Search	45
Selecting the input signal	16	RS-232C/LAN Information Timing	46
Basic Controls	17	Using Network Function	47
ASPECT Controls	19	Network Connection	47
Digital Zoom	20	Command Control	48
On-Screen Menu Displays	21	PLink™ Protocol.....	48
Adjusting Pos./Size	22	Using Web Browser Control	49
Picture Adjustments	24	Before Using Web Browser Control.....	49
Advanced settings	25	Access from Web Browser	49
Sound Adjustment	26	Display Control (BASIC CONTROL/OPTION	
PRESENT TIME Setup / Set up TIMER	27	CONTROL Screen)	50
PRESENT TIME Setup.....	27	NETWORK SETTING (NETWORK SETTING Screen) ...	51
Set up TIMER.....	28	Password Setting (CHANGE PASSWORD Screen)....	51
Screensaver (For preventing image retention)	29	Crestron Connected™ page.....	52
Setup of Screensaver Time	30	Troubleshooting	54
Wobbling	30	Applicable input signals	55
No activity power off	31	Shipping condition	56
		Specifications	57



The lightning flash with arrow-head within a triangle is intended to tell the user that parts inside the product are a risk of electric shock to persons.



The exclamation point within a triangle is intended to tell the user that important operating and servicing instructions are in the papers with the appliance.

WARNING : To prevent damage which may result in fire or shock hazard, do not expose this apparatus to rain or moisture.
Do not place containers with water (flower vase, cups, cosmetics, etc.) above the set.
(including on shelves above, etc.)

WARNING : To prevent electric shock, do not remove cover. No user serviceable parts inside. Refer servicing to qualified service personnel.

Important Safety Instructions

- 1) Read these instructions.
- 2) Keep these instructions.
- 3) Heed all warnings.
- 4) Follow all instructions.
- 5) Do not use this apparatus near water.
- 6) Clean only with dry cloth.
- 7) Do not block any ventilation openings. Install in accordance with the manufacturer's instructions.
- 8) Do not install near any heat sources such as radiators, heat registers, stoves, or other apparatus (including amplifiers) that produce heat.
- 9) Do not defeat the safety purpose of the polarized or grounding-type plug. A polarized plug has two blades with one wider than the other. A grounding type plug has two blades and a third grounding prong. The wide blade or the third prong are provided for your safety. If the provided plug does not fit into your outlet, consult an electrician for replacement of the obsolete outlet.
- 10) Protect the power cord from being walked on or pinched particularly at plugs, convenience receptacles, and the point where they exit from the apparatus.
- 11) Only use attachments / accessories specified by the manufacturer.
- 12) Use only with the cart, stand, tripod, bracket, or table specified by the manufacturer, or sold with the apparatus. When a cart is used, use caution when moving the cart / apparatus combination to avoid injury from tip-over.
- 13) Unplug this apparatus during lightning storms or when unused for long periods of time.
- 14) Refer all servicing to qualified service personnel. Servicing is required when the apparatus has been damaged in any way, such as power-supply cord or plug is damaged, liquid has been spilled or objects have fallen into the apparatus, the apparatus has been exposed to rain or moisture, does not operate normally, or has been dropped.



FCC STATEMENT

This equipment has been tested and found to comply with the limits for a Class B digital device, pursuant to Part 15 of the FCC Rules. These limits are designed to provide reasonable protection against harmful interference in a residential installation. This equipment generates, uses and can radiate radio frequency energy and, if not installed and used in accordance with the instructions, may cause harmful interference to radio communications. However, there is no guarantee that interference will not occur in a particular installation. If this equipment does cause harmful interference to radio or television reception, which can be determined by turning the equipment off and on, the user is encouraged to try to correct the interference by one or more of the following measures:

- Reorient or relocate the receiving antenna.
- Increase the separation between the equipment and receiver.
- Connect the equipment into an outlet on a circuit different from that to which the receiver is connected.
- Consult the dealer or an experienced technician for help.

This device complies with Part 15 of the FCC Rules. Operation is subject to the following two conditions: (1) This device may not cause harmful interference, and (2) this device must accept any interference received, including interference that may cause undesired operation.

FCC CAUTION:

To assure continued compliance, follow the attached installation instructions and use only shielded interface cables when connecting to computer or peripheral devices. Any changes or modifications not expressly approved by Panasonic Corp. of North America could void the user's authority to operate this device.

FCC Declaration of Conformity

Model No. TH-42LFE7U, TH-50LFE7U, TH-65LFE7U

Responsible Party: Panasonic Corporation of North America
Two Riverfront Plaza, Newark, New Jersey 07102-5490
Contact Source: Panasonic System Communications Company of North America
1-877-655-2357

CANADIAN NOTICE:

This Class B digital apparatus complies with Canadian ICES-003.

Note:

Image retention may occur. If you display a still picture for an extended period, the image might remain on the screen. However, it will disappear after a while.

Trademark Credits

- VGA is a trademark of International Business Machines Corporation.
- Microsoft®, Windows®, Windows Vista®, and Internet Explorer® are the registered trademarks or trademarks of Microsoft Corporation in the United States and/or other countries.
- Macintosh, Mac, Mac OS, OS X and Safari are the trademarks of Apple Inc. registered in the United States and other countries.
- PJLink is a pending trademark in Japan, the United States and other countries and regions.
- SVGA, XGA, SXGA and UXGA are registered trademarks of the Video Electronics Standard Association. Even if no special notation has been made of company or product trademarks, these trademarks have been fully respected.
- HDMI, the HDMI Logo, and High-Definition Multimedia Interface are trademarks or registered trademarks of HDMI Licensing LLC in the United States and other countries.
- RoomView, Crestron RoomView and Fusion RV are registered trademarks of Crestron Electronics, Inc, and Crestron Connected is the trademark of Crestron Electronics, Inc.

Important Safety Notice

WARNING

- 1) To prevent damage which may result in fire or shock hazard, do not expose this appliance to dripping or splashing.
Do not place containers with water (flower vase, cups, cosmetics, etc.) above the set. (including on shelves above, etc.)
No naked flame sources, such as lighted candles, should be placed on / above the set.
- 2) To prevent electric shock, do not remove cover. No user serviceable parts inside. Refer servicing to qualified service personnel.

CAUTION

This appliance is intended for use in environments which are relatively free of electromagnetic fields. Using this appliance near sources of strong electromagnetic fields or where electrical noise may overlap with the input signals could cause the picture and sound to wobble or cause interference such as noise to appear. To avoid the possibility of harm to this appliance, keep it away from sources of strong electromagnetic fields.

IMPORTANT INFORMATION

If a display is not positioned in a sufficiently stable location, it can be potentially hazardous due to falling. Many injuries, particularly to children, can be avoided by taking simple precautions such as:

- Using cabinets or stands recommended by the manufacturer of the display.
- Only using furniture that can safely support the display.
- Ensuring the display is not overhanging the edge of the supporting furniture.
- Not placing the display on tall furniture (for example, cupboards or bookcases) without anchoring both the furniture and the display to a suitable support.
- Not standing the displays on cloth or other materials placed between the display and supporting furniture.
- Educating children about the dangers of climbing on furniture to reach the display or its controls.

IMPORTANT: THE MOULDED PLUG

FOR YOUR SAFETY, PLEASE READ THE FOLLOWING TEXT CAREFULLY.

This display is supplied with a moulded three pin mains plug for your safety and convenience. A 10 amp fuse is fitted in this plug. Shall the fuse need to be replaced, please ensure that the replacement fuse has a rating of 10 amps and that it is approved by ASTA or BSI to BS1362.

Check for the ASTA mark  or the BSI mark  on the body of the fuse.

If the plug contains a removable fuse cover, you must ensure that it is refitted when the fuse is replaced.

If you lose the fuse cover the plug must not be used until a replacement cover is obtained.

A replacement fuse cover can be purchased from your local Panasonic dealer.

Do not cut off the mains plug.

Do not use any other type of mains lead except the one supplied with this display.

The supplied mains lead and moulded plug are designed to be used with this display to avoid interference and for your safety.

If the socket outlet in your home is not suitable, get it changed by a qualified electrician.

If the plug or mains lead becomes damaged, purchase a replacement from an authorized dealer.

How to replace the fuse. Open the fuse compartment with a screwdriver and replace the fuse.

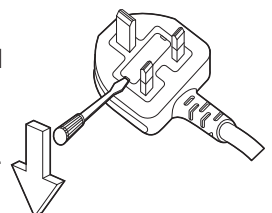

Safety Precautions

WARNING

■ Setup

This LCD Display is for use only with the following optional accessories. Use with any other type of optional accessories may cause instability which could result in the possibility of injury.

(All of the following accessories are manufactured by Panasonic Corporation.)

- Pedestal TY-ST42PE7 (for TH-42LFE7U/E/ER, TH-50LFE7U/E)
TY-ST65PE7 (for TH-65LFE7U/E)

We are not responsible for any product damage, etc. caused by use of the pedestal or wall-hanging bracket made by other companies, or by failures in the installation environment for the pedestal or wall-hanging bracket even during the warranty period.

Always be sure to ask a qualified technician to carry out set-up.

Small parts can present choking hazard if accidentally swallowed. Keep small parts away from young children. Discard unneeded small parts and other objects, including packaging materials and plastic bags/sheets to prevent them from being played with by young children, creating the potential risk of suffocation.

Do not place the Display on sloped or unstable surfaces, and ensure that the Display does not hang over the edge of the base.

- The Display may fall off or tip over.

Do not place any objects on top of the Display.

- If water is spilled onto the Display or foreign objects get inside it, a short-circuit may occur which could result in fire or electric shock. If any foreign objects get inside the Display, please consult your local Panasonic dealer.

Transport only in upright position!

- Transporting the unit with its display panel facing upright or downward may cause damage to the internal circuitry.

Ventilation should not be impeded by covering the ventilation openings with items such as newspapers, table cloths and curtains.

For sufficient ventilation;

Leave a space of 3 15/16" (10 cm) or more at the top, left and right, and 1 31/32" (5 cm) or more at the rear, and also keep the space between the bottom of the display and the floor surface.

Cautions for Wall Installation

- Wall installation should be performed by an installation professional. Installing the Display incorrectly may lead to an accident that results in death or serious injury. Furthermore, when installing on a wall, a wall hanging bracket that conforms to VESA standards (TH-42LFE7U/E/ER: VESA 200×200, TH-50LFE7U/E: VESA 400×200, TH-65LFE7U/E: VESA 400×400) must be used.
- If you terminate the use of the Display on the wall, ask a professional to remove the Display as soon as possible.
- When mounting the Display on the wall, prevent the mounting screws and power cable from contacting metal objects inside the wall. An electric shock may occur if they contact metal objects inside the wall.

When installing the Display vertically, be sure to install the power indicator onto the top of the Display.

Do not install the product to a place where the product is exposed to direct sunlight.

- If the screen is exposed to direct sunlight, the liquid crystal panel may have adverse effect.

During installation, impacts and the like may damage the Display. Please handle with care.

■ When using the LCD Display

The Display is designed to operate on 110 - 127 or 220 - 240 V AC, 50/60 Hz.

Do not cover the ventilation holes.

- Doing so may cause the Display to overheat, which can cause fire or damage to the Display.

Do not stick any foreign objects into the Display.

- Do not insert any metal or flammable objects into the ventilations holes or drop them onto the Display, as doing so can cause fire or electric shock.

Do not remove the cover or modify it in any way.

- High voltages which can cause severe electric shocks are present inside the Display. For any inspection, adjustment and repair work, please contact your local Panasonic dealer.

Ensure that the mains plug is easily accessible.

Do not use any power supply cord other than that provided with this unit.

- Doing so may cause fire or electric shocks.

Securely insert the power supply plug as far as it will go.

- If the plug is not fully inserted, heat may be generated which could cause fire. If the plug is damaged or the wall socket is loose, they shall not be used.

Do not handle the power supply plug with wet hands.

- Doing so may cause electric shocks.

Do not do anything that may damage the power cable. When disconnecting the power cable, pull on the plug body, not the cable.

- Do not damage the cable, make any modifications to it, place heavy objects on top of it, heat it, place it near any hot objects, twist it, bend it excessively or pull it. To do so may cause fire and electric shock. If the power cable is damaged, have it repaired at your local Panasonic dealer.

Do not remove covers and NEVER modify the Display yourself

- Do not remove the rear cover as live parts are accessible when it is removed. There are no user serviceable parts inside. (High-voltage components may cause serious electrical shock.)
- Have the Display checked, adjusted, or repaired at your local Panasonic dealer.

If the Display is not going to be used for any prolonged length of time, unplug the power supply plug from the wall outlet.

To prevent the spread of fire, keep candles or other open flames away from this product at all times.



■ If problems occur during use

If a problem occurs (such as no picture or no sound), or if smoke or an abnormal odour starts to come out from the Display, immediately unplug the power supply plug from the wall outlet.

- If you continue to use the Display in this condition, fire or electric shock could result. After checking that the smoke has stopped, contact your local Panasonic dealer so that the necessary repairs can be made. Repairing the Display yourself is extremely dangerous, and shall never be done.

If water or foreign objects get inside the Display, if the Display is dropped, or if the cabinet becomes damages, disconnect the power supply plug immediately.

- A short circuit may occur, which could cause fire. Contact your local Panasonic dealer for any repairs that need to be made.

Safety Precautions

CAUTION

■ When using the LCD Display

Do not bring your hands, face or objects close to the ventilation holes of the Display.

- Heated air comes out from the ventilation holes at the top of Display will be hot. Do not bring your hands or face, or objects which cannot withstand heat, close to this port, otherwise burns or deformation could result.

Be sure to disconnect all cables before moving the Display.

- If the Display is moved while some of the cables are still connected, the cables may become damaged, and fire or electric shock could result.

Disconnect the power supply plug from the wall socket as a safety precaution before carrying out any cleaning.

- Electric shocks can result if this is not done.

Clean the power cable regularly to prevent it becoming dusty.

- If dust built up on the power cord plug, the resultant humidity can damage the insulation, which could result in fire. Pull the power cord plug out from the wall outlet and wipe the mains lead with a dry cloth.

Do not burn or breakup batteries.

- Batteries must not be exposed to excessive heat such as sunshine, fire or the like.

Cleaning and maintenance

The front of the display panel has been specially treated. Wipe the panel surface gently using only a cleaning cloth or a soft, lint-free cloth.

- If the surface is particularly dirty, wipe with a soft, lint-free cloth which has been soaked in pure water or water in which neutral detergent has been diluted 100 times, and then wipe it evenly with a dry cloth of the same type until the surface is dry.
- Do not scratch or hit the surface of the panel with fingernails or other hard objects, otherwise the surface may become damaged. Furthermore, avoid contact with volatile substances such as insect sprays, solvents and thinner, otherwise the quality of the surface may be adversely affected.

If the cabinet becomes dirty, wipe it with a soft, dry cloth.

- If the cabinet is particularly dirty, soak the cloth in water to which a small amount of neutral detergent has been added and then wring the cloth dry. Use this cloth to wipe the cabinet, and then wipe it dry with a dry cloth.
- Do not allow any detergent to come into direct contact with the surface of the Display. If water droplets get inside the unit, operating problems may result.
- Avoid contact with volatile substances such as insect sprays, solvents and thinner, otherwise the quality of the cabinet surface may be adversely affected or the coating may peel off. Furthermore, do not leave it for long periods in contact with articles made from rubber or PVC.

Usage of a chemical cloth

- Do not use a chemical cloth for the panel surface.
- Follow the instructions for the chemical cloth to use it for the cabinet.

Notes before use

The usage environment of the liquid crystal panel may have an effect on the screen display. In addition, depending on the viewing angle, changes in hue or irregularities in brightness may occur.

- Please note that this is a characteristic of the liquid crystal panel and not a malfunction.

Accessories

Accessories Supply

Check that you have the accessories and items shown



Operating Instruction book

CD-ROM
(Operating instructions)

Remote Control
Transmitter
N2QAYB000691

Batteries for the Remote
Control Transmitter
(R6 (UM3) Size × 2)

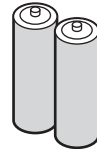
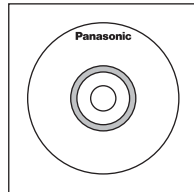
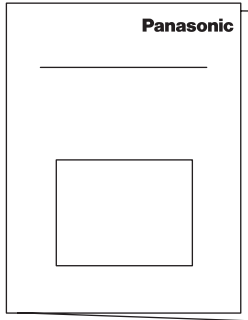

Power supply cord

TH-42LFE7U, TH-50LFE7U, TH-65LFE7U	TH-42LFE7E/ER, TH-50LFE7E, TH-65LFE7E

Attention

Store small parts in an appropriate manner, and keep them away from young children.

Remote Control Batteries

Requires two R6 batteries.

1. Pull and hold the hook, then open the battery cover.
2. Insert batteries - note correct polarity (+ and -).
3. Replace the cover.

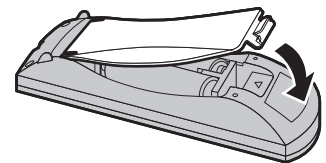
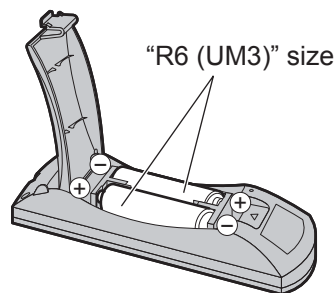
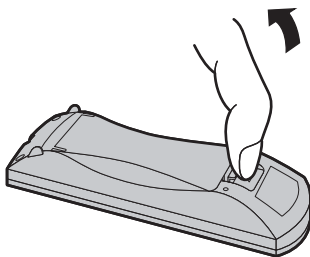

Helpful Hint:

For frequent remote control users, replace old batteries with Alkaline batteries for longer life.

⚠️ Precaution on battery use

Incorrect installation can cause battery leakage and corrosion that will damage the remote control transmitter. Disposal of batteries should be in an environment-friendly manner.

Observe the following precaution:

1. Batteries shall always be replaced as a pair. Always use new batteries when replacing the old set.
2. Do not combine a used battery with a new one.
3. Do not mix battery types (example: "Zinc Carbon" with "Alkaline").
4. Do not attempt to charge, short-circuit, disassemble, heat or burn used batteries.
5. Battery replacement is necessary when remote control acts sporadically or stops operating the Display set.
6. Do not burn or breakup batteries.
Batteries must not be exposed to excessive heat such as sunshine, fire or the like.

Connections

AC cord connection

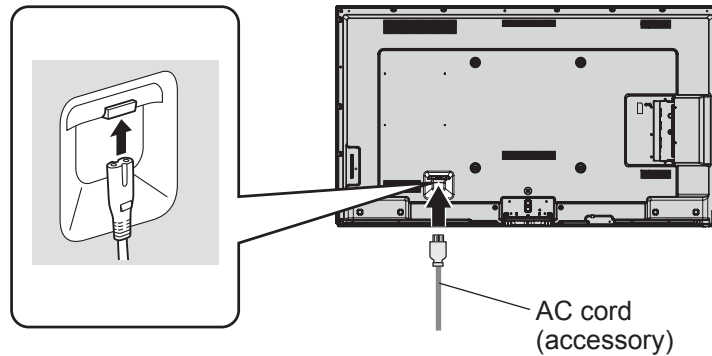

Notes:

- Insert the AC cord firmly into place.
- When disconnecting the AC cord, be absolutely sure to disconnect the AC cord plug at the socket outlet first.
- The included AC cord is for use with this unit only.

Video equipment connection

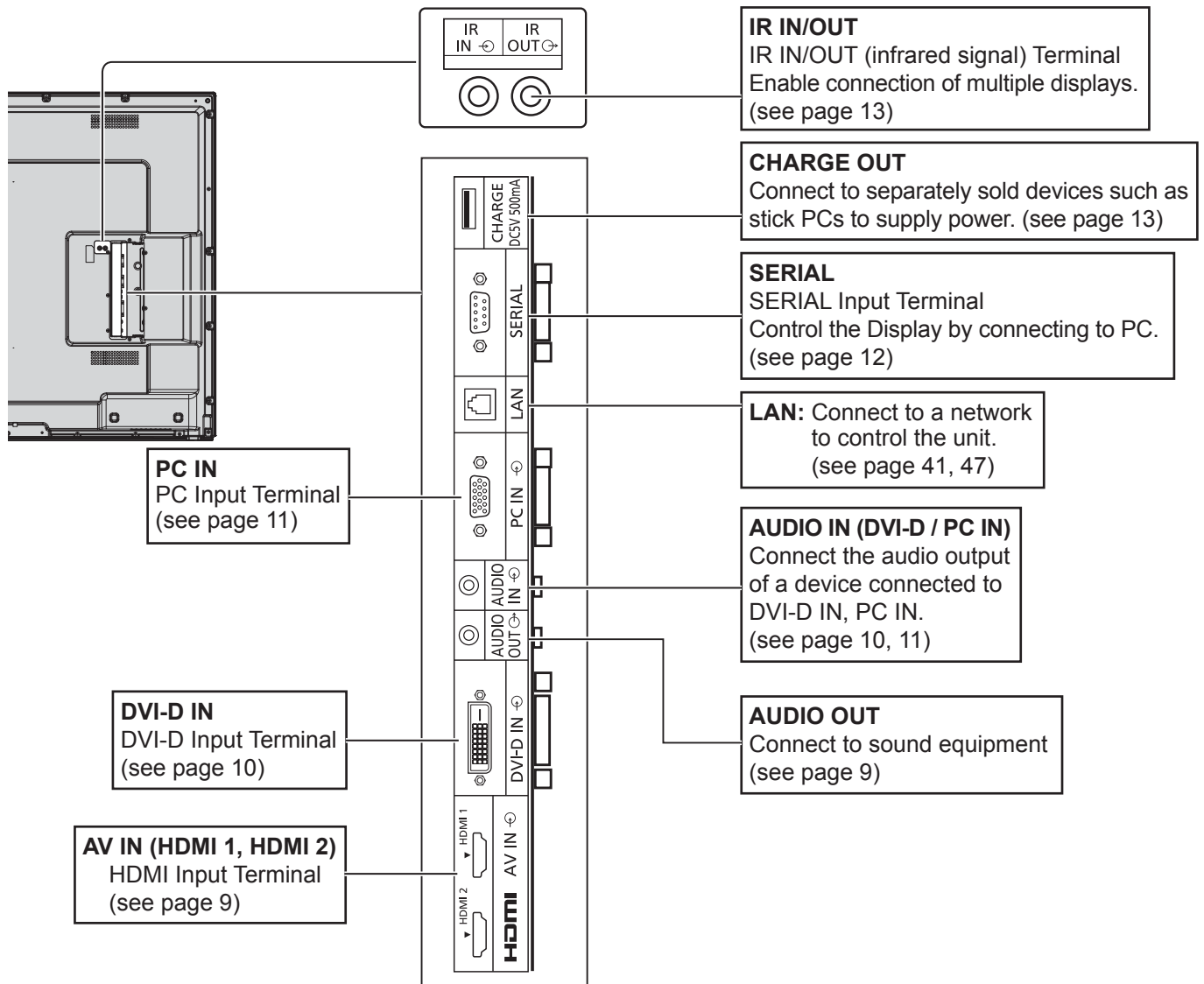

AUDIO OUT connection

Notes:

- Additional equipment and cables shown are not supplied with this set.
- To output sound from the AUDIO OUT terminal of the Display, be sure to set “Output Select” to “AUDIO OUT” in the “Sound Adjustment” menu. (see page 26)

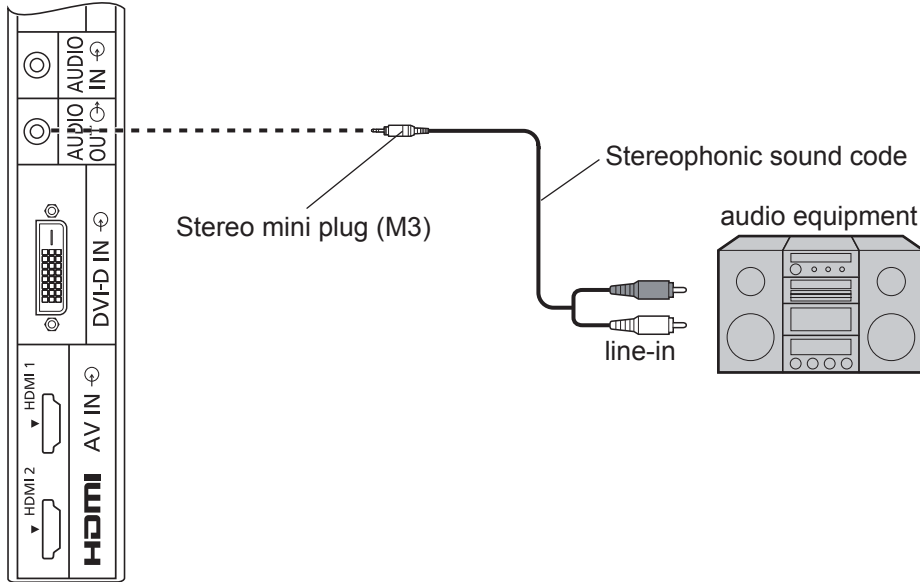

HDMI connection

[Pin assignments and signal names]

Pin No.	Signal name	Pin No.	Signal name
①	T.M.D.S Data2+	⑪	T.M.D.S Clock Shield
②	T.M.D.S Data2 Shield	⑫	T.M.D.S Clock-
③	T.M.D.S Data2-	⑬	CEC
④	T.M.D.S Data1+	⑭	Reserved (N.C. on device)
⑤	T.M.D.S Data1 Shield		
⑥	T.M.D.S Data1-	⑮	SCL
⑦	T.M.D.S Data0+	⑯	SDA
⑧	T.M.D.S Data0 Shield	⑰	DDC/CEC Ground
⑨	T.M.D.S Data0-	⑱	+5V Power
⑩	T.M.D.S Clock+		Hot Plug Detect

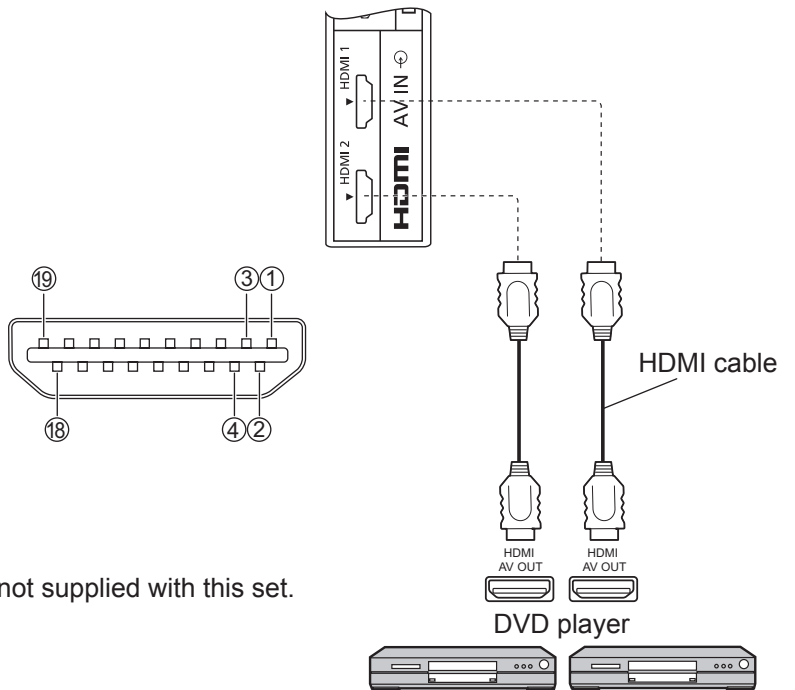

Note:

Additional equipment and HDMI cable shown are not supplied with this set.

DVI-D IN connection

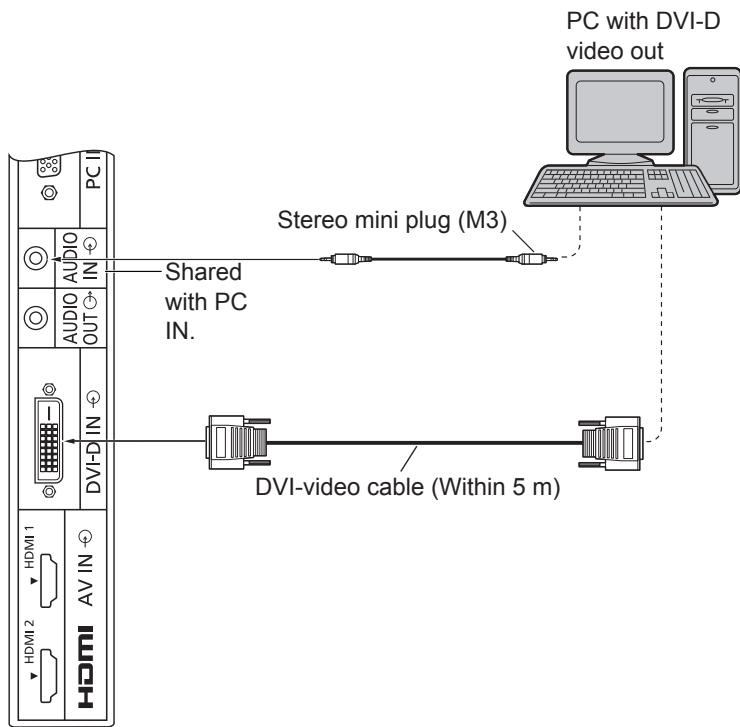

DVI-D Input Connector Pin Layouts

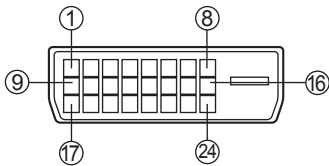

Connection port view

Pin No.	Signal Name	Pin No.	Signal Name
①	T.M.D.S. data 2-	⑬	_____
②	T.M.D.S. data 2+	⑭	+5 V DC
③	T.M.D.S. data 2 shield	⑮	Ground
④	_____	⑯	Hot plug detect
⑤	_____	⑰	T.M.D.S. data 0-
⑥	DDC clock	⑱	T.M.D.S. data 0+
⑦	DDC data	⑲	T.M.D.S. data 0 shield
⑧	_____	⑳	_____
⑨	T.M.D.S. data 1-	㉑	_____
⑩	T.M.D.S. data 1+	㉒	T.M.D.S. clock shield
⑪	T.M.D.S. data 1 shield	㉓	T.M.D.S. clock+
⑫	_____	㉔	T.M.D.S. clock-

Notes:

- Additional equipment and cables shown are not supplied with this set.
- Image deterioration may occur depending on the length or the quality of the cable.

PC Input Terminals connection

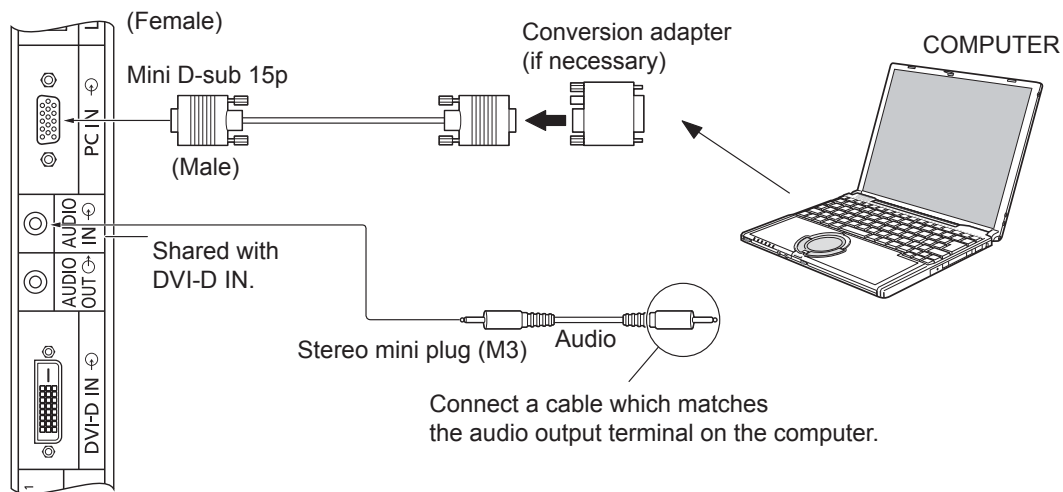

Notes:

- Computer signals which can be input are those with a horizontal scanning frequency of 30 to 110 kHz and vertical scanning frequency of 48 to 120 Hz. (However, the image will not be displayed properly if the signals exceed 1,200 lines.)
- The display resolution is a maximum of 1,440 × 1,080 dots when the aspect mode is set to “4:3”, and 1,920 × 1,080 dots when the aspect mode is set to “16:9”. If the display resolution exceeds these maximums, it may not be possible to show fine detail with sufficient clarity.
- The PC input terminals are DDC2B-compatible. If the computer being connected is not DDC2B-compatible, you will need to make setting changes to the computer at the time of connection.
- Some PC models cannot be connected to the set.
- There is no need to use an adapter for computers with DOS/V compatible Mini D-sub 15P terminal.
- The computer shown in the illustration is for example purposes only.
- Additional equipment and cables shown are not supplied with this set.
- Do not set the horizontal and vertical scanning frequencies for PC signals which are above or below the specified frequency range.

Signal Names for Mini D-sub 15P Connector

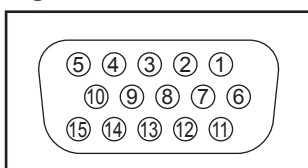

Pin Layout for PC Input Terminal

Pin No.	Signal Name	Pin No.	Signal Name	Pin No.	Signal Name
①	R	⑥	GND (Ground)	⑪	NC (not connected)
②	G	⑦	GND (Ground)	⑫	SDA
③	B	⑧	GND (Ground)	⑬	HD/SYNC
④	NC (not connected)	⑨	+5 V DC	⑭	VD
⑤	GND (Ground)	⑩	GND (Ground)	⑮	SCL

SERIAL Terminals connection

The SERIAL terminal is used when the Display is controlled by a computer.

Note:

To use serial control for this unit, make sure to set the “Control I/F Select” in the “Network Setup” menu to “RS-232C”. (see page 41)

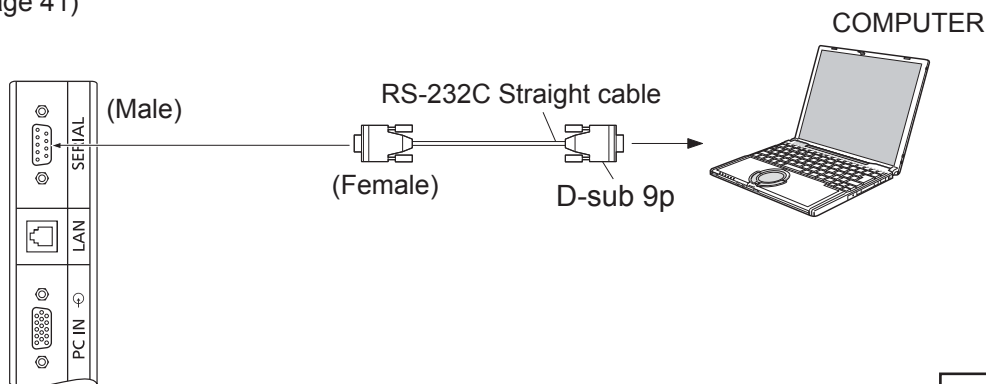

Notes:

- Use the RS-232C straight cable to connect the computer to the Display.
- The computer shown is for example purposes only.
- Additional equipment and cables shown are not supplied with this set.

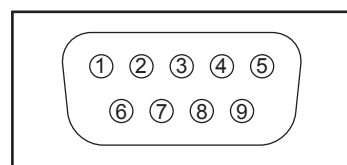

Pin layout for SERIAL Terminal

The SERIAL terminal conforms to the RS-232C interface specification, so that the Display can be controlled by a computer which is connected to this terminal.

The computer will require software which allows the sending and receiving of control data which satisfies the conditions given below. Use a computer application such as programming language software. Refer to the documentation for the computer application for details.

Communication parameters

Signal level	RS-232C compliant
Synchronization method	Asynchronous
Baud rate	9600 bps
Parity	None
Character length	8 bits
Stop bit	1 bit
Flow control	-

Signal names for SERIAL IN terminal

Pin No.	Details
②	R X D
③	T X D
④	DTR
⑤	GND
⑥	DSR
⑦ ⑧	⌋ (Shorted in this set)
① • ⑨	

These signal names are those of computer specifications.

Basic format for control data

The transmission of control data from the computer starts with a STX signal, followed by the command, the parameters, and lastly an ETX signal in that order. If there are no parameters, then the parameter signal does not need to be sent.

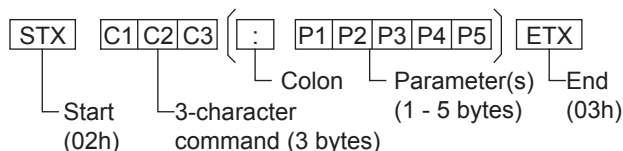

Notes:

- If multiple commands are transmitted, be sure to wait for the response for the first command to come from this unit before sending the next command.
- If an incorrect command is sent by mistake, this unit will send an “ER401” command back to the computer.
- Consult an Authorized Service Center for detail instructions on command usage.

Command

Command	Parameter	Control details
PON	None	Power ON
POF	None	Power OFF
AVL	***	Volume 000 - 100
AMT	0	Audio MUTE OFF
	1	Audio MUTE ON
IMS	None	Input select (toggle)
	HM1	HDMI 1 input (HDMI1)
	HM2	HDMI 2 input (HDMI2)
	DV1	DVI-D IN input (DVI)
DAM	None	Screen mode select (toggle)
	ZOOM	Zoom1
	FULL	16:9
	NORM	4:3
	ZOM2	Zoom2

With the power off, this display responds to PON command only.

IR IN/OUT (infrared signal) connection

Connect between the IR OUT terminal of the first display and the IR IN terminal of the second display with a 3.5 mm stereo mini plug.

Infrared signals will be sent from the first display to the second display.

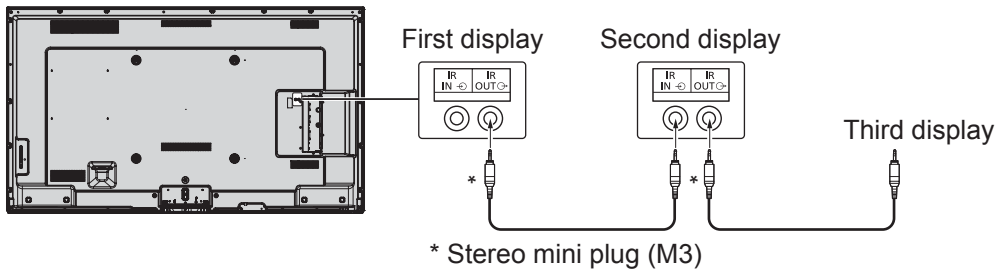

IR of the second display will not work in this connection.

It is possible to configure a daisy chain connection by repeating the connection above.

CHARGE Terminals connection

Power can be supplied when a separately sold stick PC or such other device is connected.

Note:

To supply power, be sure to set “5V Charge” to “On” in the “Options” menu. (see page 44)

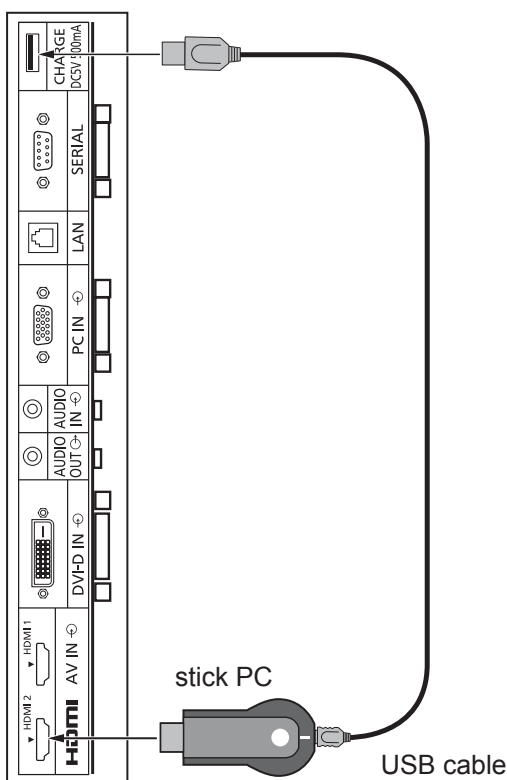

Pin Layout and Signal Names of CHARGE Terminal

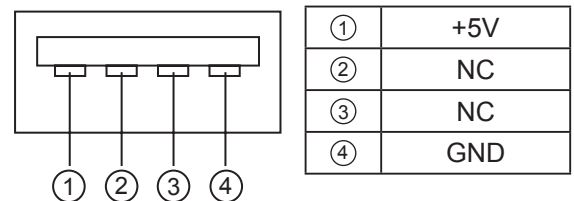

Up to 5V/500 mA power can be supplied to an external device when an image is received.

- If current exceeding the supply capacity flows, output will be shut off and the following message will appear.
“5V CHARGE OUT overload. Please remove cable, then turn the display off/on.”

In this case, turn the power off and on with the remote control, etc.

Note:

If there is dust in a terminal, the protection circuit may function.

Cover the terminals, such as with tape, when not in use.

(The terminals are protected by tape when shipped from the factory.)

Power On / Off

Connecting the AC cord plug to the Display.

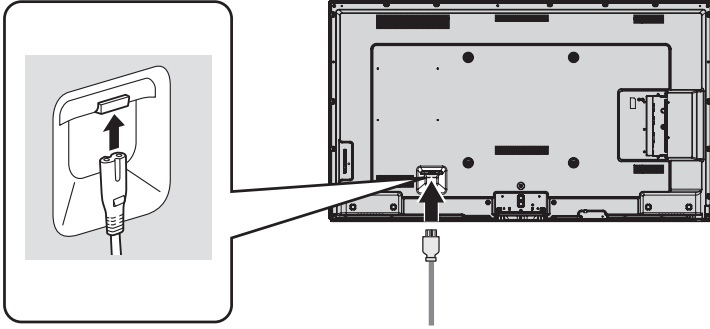

Connecting the plug to the Wall Outlet

Notes:

- Main plug types vary between countries. The power plug shown at right may, therefore, not be the type fitted to your set.
- When disconnecting the AC cord, be absolutely sure to disconnect the AC cord plug at the socket outlet first.

Press the Power switch on the Display to turn the set on: Power-On.

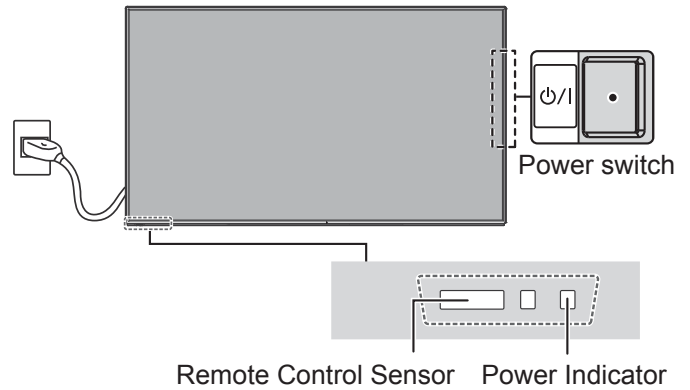

Power Indicator: Green



Press the  button on the remote control to turn the Display off.

Power Indicator: Red (standby)

Press the  button on the remote control to turn the Display on.

Power Indicator: Green

Turn the power to the Display off by pressing the  switch on the unit, when the Display is on or in standby mode.

Note:

During operation of the power management function, the power indicator turns orange in the power off state.



When first switching on the unit

Following screen will be displayed when the unit is turned on for the first time. Select the items with the remote control. Unit buttons are invalid.

OSD Language

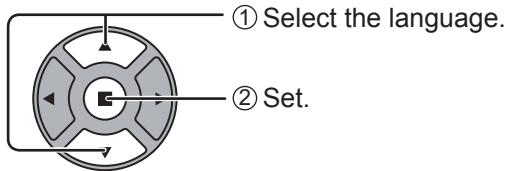

PRESENT TIME Setup

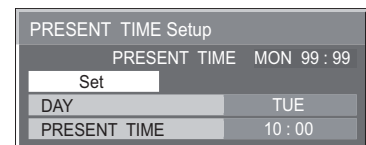
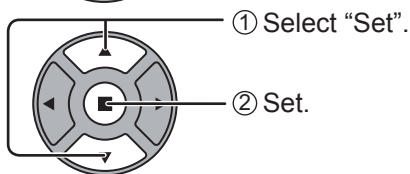
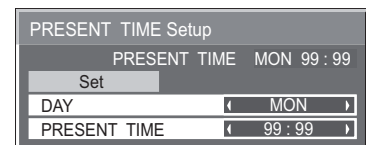
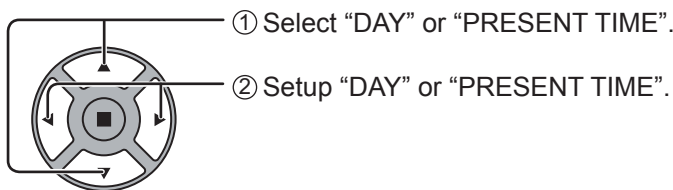

Notes:

- Once the items are set, the screens won't be displayed when switching on the unit next time.
- After the setting, the items can be changed in the following menus.
 OSD Language (see page 34)
 PRESENT TIME Setup (see page 27)

Power ON warning message

The following message may be displayed when turning the unit power ON:

No activity power off Precautions



If "No activity power off" in Setup menu is set to "Enable", a warning message is displayed every time the power is turned ON. (see page 31)

This message display can be set with the following menu: Options menu

Power On Message (see page 44)

Selecting the input signal

INPUT



Press to select the input signal to be played back from the equipment which has been connected to the Display.

Input signals will change as follows:

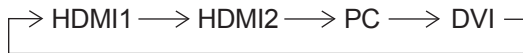

HDMI1: HDMI input terminal in AV IN (HDMI1).

HDMI2: HDMI input terminal in AV IN (HDMI2).

PC: PC input terminal in PC IN.

DVI: DVI input terminal in DVI-D IN.



Note:

Selecting is also possible by pressing the INPUT button on the unit.

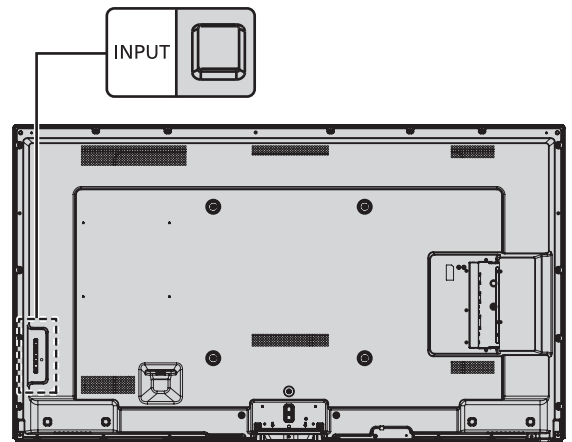

Basic Controls

Main Unit

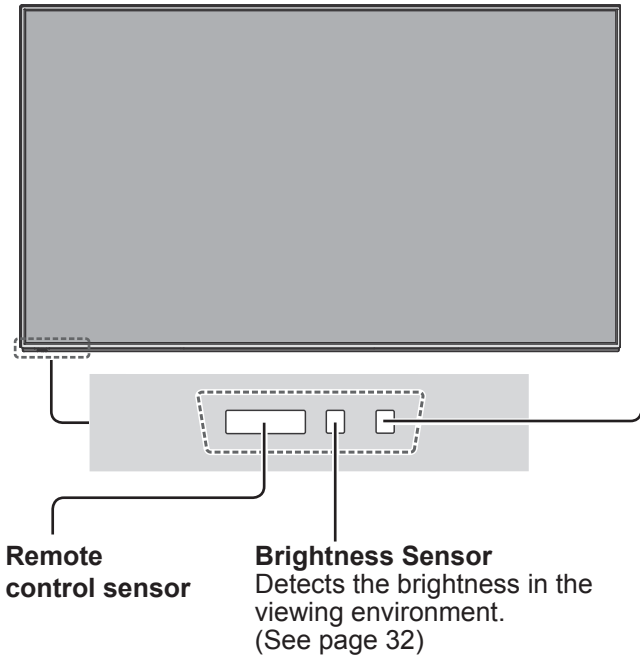

Power Indicator

The Power Indicator will light.

- Power-OFF Indicator not illuminated (The unit will still consume some power as long as the power cord is still inserted into the wall outlet.)
- Standby Red
Orange (When the control terminal selection is "LAN". See page 41)
- Power-ON Green
- HDMI1 Power management
HDMI2 Power management
..... Orange (With HDMI1 or HDMI2 input signal. See page 32)
- PC Power management
..... Orange (With PC input signal. See page 32)
- DVI-D Power management
..... Orange (With DVI input signal. See page 32)

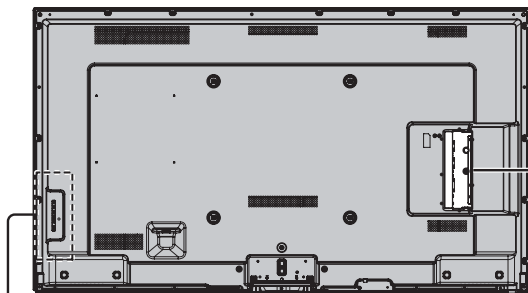

External input terminals

Connects such devices as video equipment or personal computers. (see page 8)

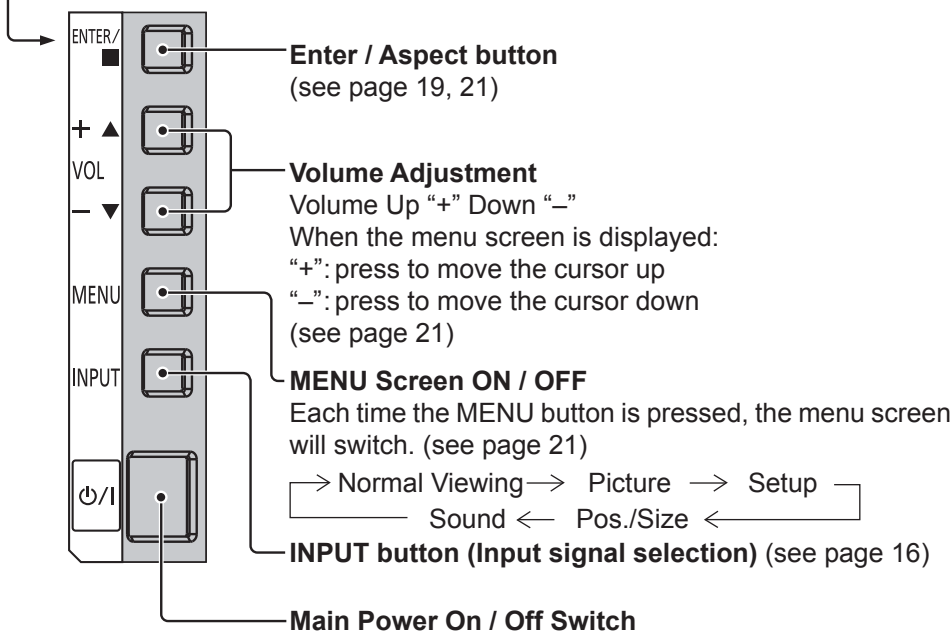
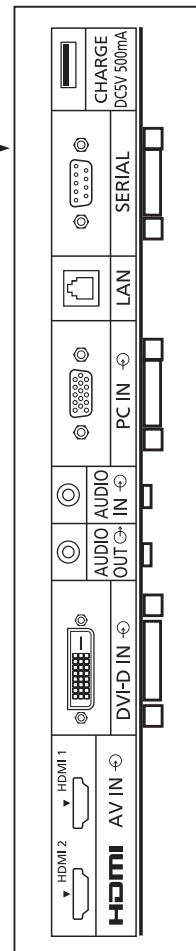

Remote Control Transmitter

ACTION button
Press to make selections.

ASPECT button
Press to adjust the aspect.
(see page 19)

Standby (ON / OFF) button
The Display must first be plugged into the wall outlet and turned on at the power switch (see page 14).
Press this button to turn the Display On, from Standby mode. Press it again to turn the Display Off to Standby mode.

POS. /SIZE button
(see page 22, 23)

PICTURE button
(see page 24, 25)

Sound mute On / Off
Press this button to mute the sound.
Press again to reactivate sound.
Sound is also reactivated when power is turned off or volume level is changed.

N button
(see page 23, 24, 25, 26)

POSITION buttons

INPUT button
Press to select input signal sequentially.
(see page 16)

ECO MODE (ECO)
Press to change the ECO MODE setup status. (see page 32)

FUNCTION buttons (FUNCTION)
(see page 45)

OFF TIMER button

The Display can be preset to switch to stand-by after a fixed period. The setting changes to 30 minutes, 60 minutes, 90 minutes and 0 minutes (off timer cancelled) each time the button is pressed.

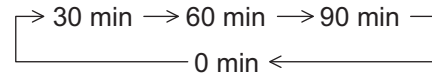

When three minutes remain, "Off timer 3 min" will flash.

The off timer is cancelled if a power interruption occurs.

AUTO SETUP button

Automatically adjusts the position/size of the screen. (see page 22)

SET UP button (see page 27 - 42)

SOUND button (see page 26)

Volume Adjustment

Press the Volume Up "+" or Down "-" button to increase or decrease the sound volume level.

R button (see page 21)

Press the R button to return to previous menu screen.

RECALL button

Press the "RECALL" button to display the current system status.

- ① Input label
- ② Aspect mode (see page 19)
- ③ Off timer

The off timer indicator is displayed only when the off timer has been set.

- ④ Clock display (see page 44)

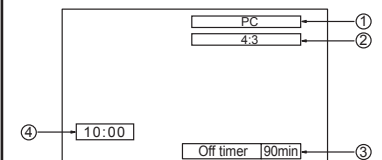

Digital Zoom (see page 20)

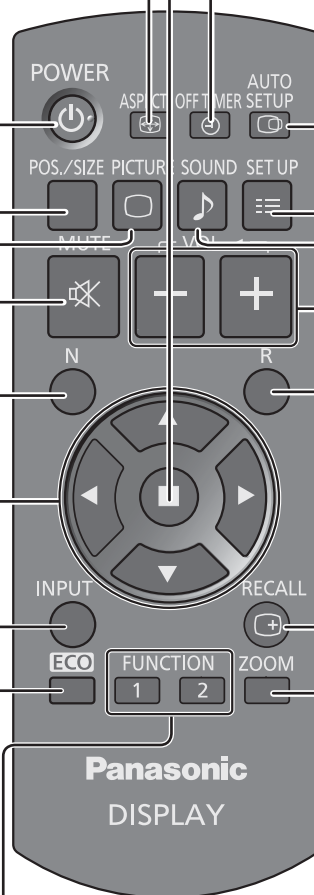

ASPECT Controls

The Display will allow you to enjoy viewing the picture at its maximum size, including wide screen cinema format picture.

Note:

Be aware that if you put the display in a public place for commercial purposes or a public showing and then use the aspect mode select function to shrink or expand the picture, you may be violating the copyright under copyright law. It is prohibited to show or alter the copyrighted materials of other people for commercial purposes without the prior permission of the copyright holder.

ASPECT



Press repeatedly to move through the aspect options:

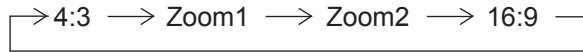

[from the unit]

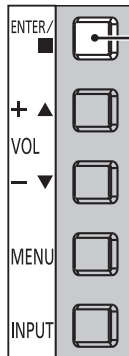

The aspect mode changes each time the ENTER button is pressed.



Note:

The aspect mode is memorized separately for each input terminal.

Aspect mode	Picture → Enlarged screen	Description
16:9		The display of the pictures fills the screen. In the case of SD signals, pictures with a 4:3 aspect ratio are enlarged horizontally, and displayed. This mode is suited to displaying anamorphic pictures with a 16:9 aspect ratio.
4:3		Pictures with a 4:3 aspect ratio are displayed with their original aspect ratio. Side panels are displayed at the left and right edges of the screen.
		Pictures with a 16:9 aspect ratio are displayed with their original aspect ratio. The left and right edges of the pictures are masked by side panels.
Zoom1		Letterbox pictures with a 16:9 aspect ratio are enlarged vertically and horizontally so that their display fills the screen. The top and bottom edges of the pictures are cut off.
Zoom2		Letterbox pictures with a 16:9 aspect ratio are enlarged vertically and horizontally so that their display fills the screen. The top and bottom edges as well as the left and right edges of the pictures are cut off.

Digital Zoom

This displays an enlargement of the designated part of the displayed image.

1 Display the operation guide.

ZOOM
 Press to access Digital Zoom.
 The operation guide will be displayed.

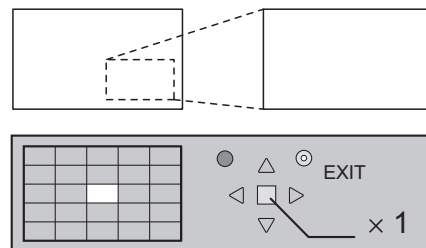

During Digital Zoom, only the following buttons can be operated.

[Remote control]

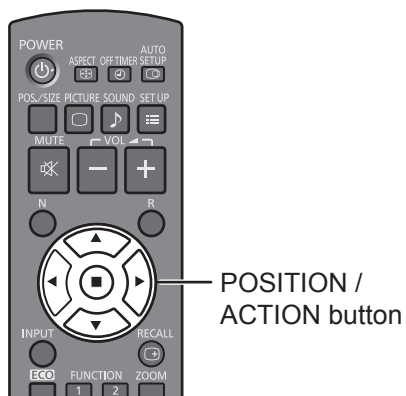

2 Select the area of the image to be enlarged.

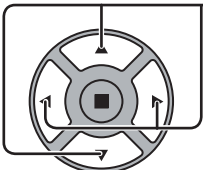
 Press on the enlargement location to select.
 The cursor will move.

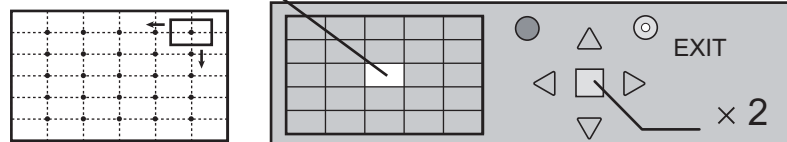

3 Select the magnification required for the enlarged display.

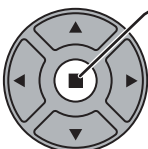
 Each time this is pressed, the magnification factor changes.
 This is shown in the image being displayed.



4 Return to normal display (quit Digital Zoom).

R
 Press to exit from the Digital Zoom.

Notes:

- When power goes OFF (including "Off Timer" operation), Digital Zoom terminates.
- The Digital Zoom function cannot be selected while in the following operation state:
 When MULTI DISPLAY Setup is On (see page 35).
 When Screensaver is running. (see page 29, 30)
- While Digital Zoom is in operation, "Adjusting Pos./Size" cannot be used.

On-Screen Menu Displays

Remote Control

Unit

1 Display the menu screen.



Press to select.
(Example: Picture menu)

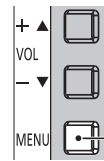

Press several times.

Each time the MENU button is pressed, the menu screen will switch.

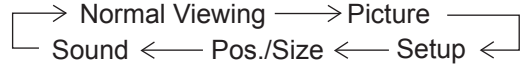

2 Select the item.

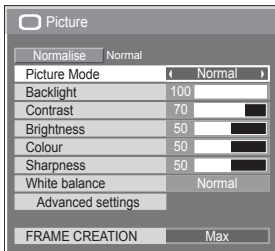

(Example: Picture menu)

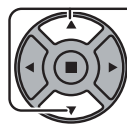

Select.

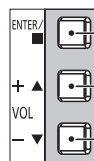

2 Press.

1 Select.

3 Set.



Adjust.

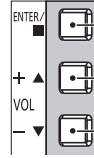

2 Press.

1 Adjust.

4 Exit the menu.



Press.

Press R to return to the previous menu.

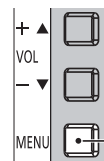

Press several times.

Menu display list

Note: Menu that cannot be adjusted is grayout. Adjustable menu changes depending on signal, input and menu setting.

Picture menu

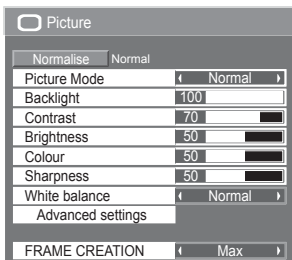

see page 24, 25

Setup menu

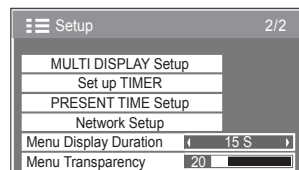
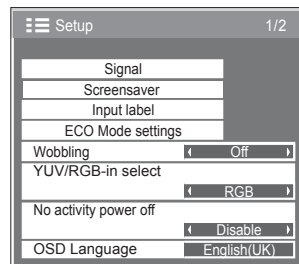

see page 27-42

Pos./Size menu

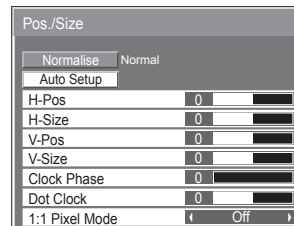

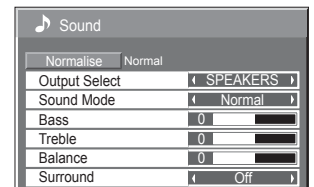

see page 22, 23

Sound menu

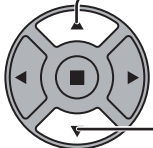
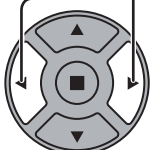

see page 26

Adjusting Pos./Size

- 1  Press to display the Pos./Size menu.
- 2  Press to select the menu to adjust.
- 3  Press to adjust the menu.
- 4  Press to exit from adjust mode.

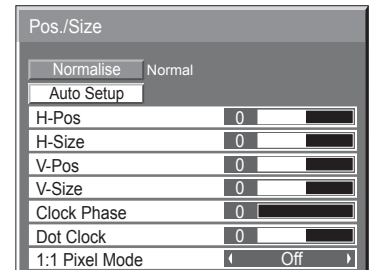

Note:

Unadjustable items are grayed out. Adjustable items differ depending on the input signal and the display mode.

Note:

If a "Cue" or "Rew" signal from a VCR or DVD player is received, the picture position will shift up or down. This picture position movement cannot be controlled by the Pos./Size function.

AUTO SETUP

H-Pos/V-Pos, H-Size/V-Size, Dot Clock and Clock Phase are automatically adjusted when the PC signal is received.

This setting only operates when a PC signal is input, and the aspect is "16:9".

Using Remote Control



When  on the remote control is pressed, "Auto Setup" will be executed.

When Auto Setup does not work, "Invalid" is displayed.

Notes:

- Auto Setup may not work when a cropped or dark image is input. In such case, switch to a bright image with borders and other objects are clearly shown, and then try auto setup again.
- Depending on the signal, out of alignment may occur after Auto Setup. Carry out fine tuning for the position/size as required.
- If Auto Setup cannot set properly for vertical frequency 60Hz XGA signal (1024×768@60Hz and 1366×768@60Hz), pre-selecting the individual signal in "XGA MODE" (see page 39) may results in correct Auto Setup.
- Auto Setup does not work well when a signal such as additional information is superimposed out of valid image period or intervals between synchronizing and image signals are short.
- If Auto Setup cannot adjust correctly, select "Normalise" once and press ACTION (■) then adjust Pos./Size manually.
- If the picture goes off screen in the horizontal direction as a result of performing Auto Setup, perform Dot Clock adjustment.

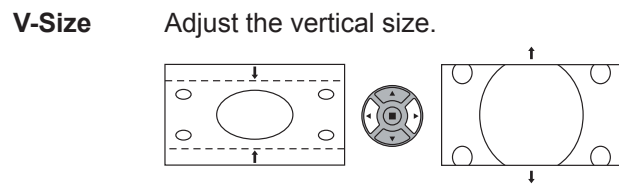
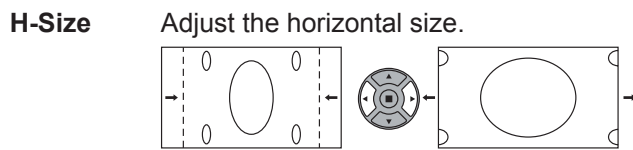
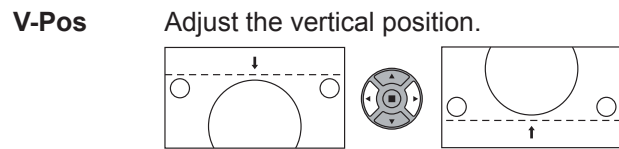
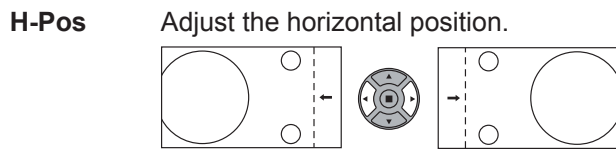

Clock Phase **(During PC input signal)**
Eliminate the flickering and distortion.

Dot Clock **(During PC input signal)**
Periodic striped pattern interference (noise) may occur when a striped pattern is displayed. If this happens, adjust so that any such noise is minimized.

Over scan Turn image over scan On/Off.
Configurable signals are as follows:
525i, 525p, 625i, 625p, 750/60p, 750/50p (DVI, HDMI)

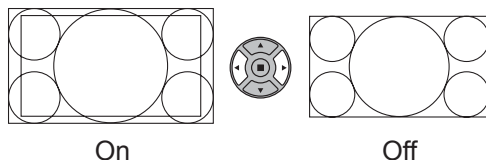

Notes:

- “Off” is effective during only “16:9” aspect mode.
- When “Off” is set, “H-Size” and “V-Size” cannot be adjusted.

1:1 Pixel Mode Adjusts the display size when 1125i or 1125p signal is input.

Notes:

- “On” is effective during only “16:9” aspect mode.
- Select On when you would like to replay 1920 × 1080 input signal.
- Applicable input signal;
1125 (1080) / 50i · 60i · 24psF · 24p · 25p · 30p · 50p · 60p
- Select Off when flickering is shown around the image.
- H-Size and V-Size cannot be adjusted when On is selected.

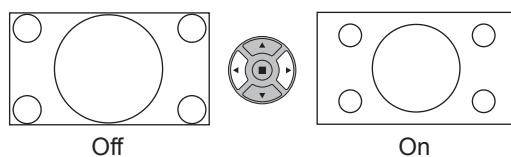

Helpful Hint (/ **Normalise** Normalisation)

While the Pos. / Size display is active, if either the N button on the remote control is pressed at any time or the ACTION () button is pressed during “Normalise”, then all adjustment values (except “Clock Phase” and “Dot Clock”) are returned to the factory settings.

Picture Adjustments

1  Press to display the Picture menu.

2 Select to adjust each item.

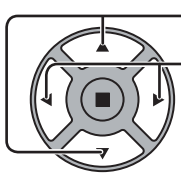
 Press to select the menu to adjust.
 Select the desired level by looking at the picture behind the menu.

Note:
 Menu that cannot be adjusted is grayout. Adjustable menu changes depending on signal, input and menu setting.

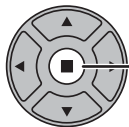
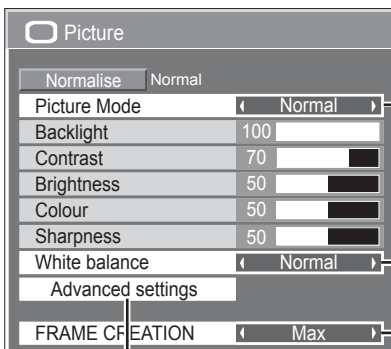

Press to enter Advanced Settings.

Advanced settings
 Enables fine picture adjustment at a professional level (see next page).

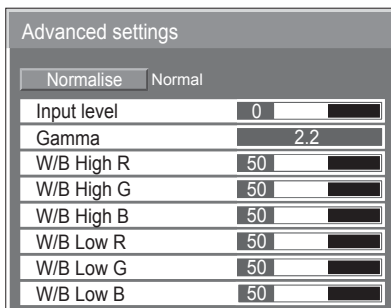

Press the left ◀ or right ▶ button to switch between modes.

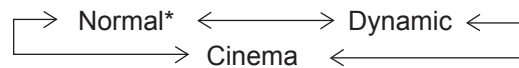

Normal

For viewing in standard environments.

* In “ENGLISH (US)” OSD language, this is displayed as “STANDARD”.

Dynamic

For viewing in brighter environments.

Cinema

For use in viewing tone-focused pictures with brightness reduced.

Notes:

- If you would like to change the picture and colour of the selected Picture menu to something else, adjust using the items in the Picture menu. (see next page)
- In “ENGLISH (US)” OSD language, the “Picture Mode” is displayed as “PICTURE MENU”.

Press the left ◀ or right ▶ button to switch between modes.



- In “ENGLISH (US)” OSD language, the “White balance” is displayed as “COLOR TEMP”.

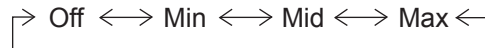

FRAME CREATION

Improves motion picture quality by reducing motion blur. Press the left ◀ or right ▶ button to switch between modes.













Notes:

- The mode is memorized per input terminal.
- Even if “Normalise” is selected, the Normal setting will not be restored.
- The picture and menu will disappear for a moment if you switch the mode to Off, or switch from Off to another mode.
- “FRAME CREATION” is not available for 42-inch models.

Helpful Hint ( /  Normalization)

While the “Picture” menu is displayed, if either the N button on the remote control is pressed at any time or the ACTION () button is pressed during “Normalise”, then all adjustment values are returned to the factory settings.

















Item	Effect	Adjustments
Backlight	  Darker Brighter	Adjusts luminance of the back light.
Contrast*	  Less More	Selects the proper brightness and density for the room.
Brightness	  Darker Brighter	Adjusts for easier viewing of dark pictures such as night scenes and black hair.
Colour	  Less More	Adjusts colour saturation.
Sharpness	  Less More	Adjusts picture sharpness.

Notes:

- You can change the level of each function (Backlight, Contrast, Brightness, Sharpness) for each Picture Mode.
- The setting details for normal, dynamic and cinema respectively are memorized separately for each input terminal.
- “Backlight” can be adjusted when “ECO Mode” is set to “Custom” and “Power save” to “Off”. (see page 32)

* In “ENGLISH (US)” OSD language, this is displayed as “PICTURE”.

Advanced settings

Item	Effect	Details
Input level	  Less More	Adjustment of parts which are extremely bright and hard to see.
Gamma	  Down Up	S Curve \longleftrightarrow 2.0 \longleftrightarrow 2.2 \longleftrightarrow 2.6
W/B High R	  Less More	Adjusts the white balance for light red areas.
W/B High G	  Less More	Adjusts the white balance for light green areas.
W/B High B	  Less More	Adjusts the white balance for light blue areas.
W/B Low R	  Less More	Adjusts the white balance for dark red areas.
W/B Low G	  Less More	Adjusts the white balance for dark green areas.
W/B Low B	  Less More	Adjusts the white balance for dark blue areas.

Notes:

- Carry out “W/B” adjustment as follows.
 1. Adjust the white balance of the bright sections using the “W/B High R”, “W/B High G” and “W/B High B” settings.
 2. Adjust the white balance of the dark sections using the “W/B Low R”, “W/B Low G” and “W/B Low B” settings.
 3. Repeat steps 1 and 2 to adjust.
 Steps 1 and 2 affect each other’s settings, so repeat each step in turn to make the adjustment.
- The adjustment values are memorized separately for each input terminal.
- The adjustment range values should be used as an adjustment reference.

Helpful Hint (/ **Normalise** **Normalisation**)

On the remote control unit, while the “Advanced settings” menu is displayed, if either the N button is pressed at any time or the ACTION (■) button is pressed during “Normalise”, then all adjustment values are returned to the factory settings.

Sound Adjustment

1  Press to display the SOUND menu.

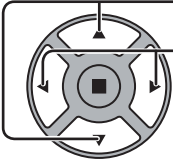
2 Select to adjust each item.
 Press to select the menu to adjust.
 Select the desired level by listening to the sound.

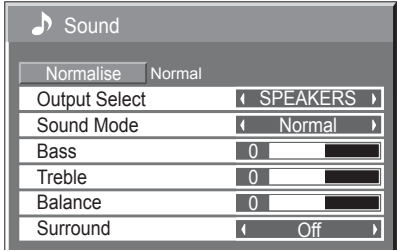



3  Press to exit from adjust mode.

Item	Details
Output Select	SPEAKERS: Emits sound from the built-in speakers. AUDIO OUT: Emits sound through the AUDIO OUT terminal.
Sound Mode	Normal: Emits the original sound. Dynamic: Accentuates sharp sound. Clear: Attenuates human voice.
Bass	Adjusts low pitch sounds.
Treble	Adjusts high pitch sounds.
Balance	Adjusts left and right volumes.
Surround	Select On or Off.

Notes:

- When “AUDIO OUT” is selected, the items other than “Balance” cannot be adjusted.
- Bass, Treble and Surround settings are memorized separately for each Sound Mode.

Helpful Hint ( /  Normalisation)

While the “Sound” menu is displayed, if either the N button on the remote control is pressed at any time or the ACTION () button is pressed during “Normalise”, then all adjustment values are returned to the factory settings.

PRESENT TIME Setup / Set up TIMER

The timer can switch the Display On or Off.

Before attempting Timer Set, confirm the PRESENT TIME and adjust if necessary. Then set POWER ON Time / POWER OFF Time.

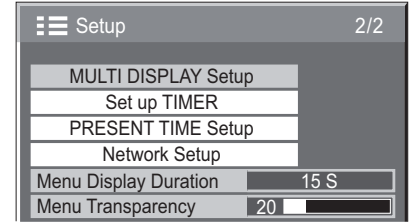

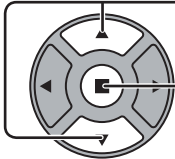
-  Press to display the Setup menu.
-  Press to select Set up TIMER or PRESENT TIME Setup.
Press to display the Set up TIMER screen or PRESENT TIME Setup screen.

PRESENT TIME Setup

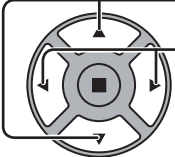
-  Press to select DAY or PRESENT TIME.
Press to setup DAY or PRESENT TIME.
▶ button: Forward
◀ button: Back

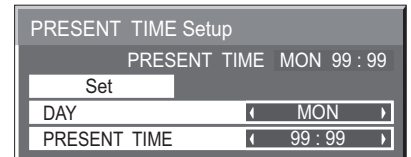

Notes:

- Pressing “◀” or “▶” button once changes PRESENT TIME 1 minute.
- Pressing “◀” or “▶” button continuously changes PRESENT TIME by 15 minutes.

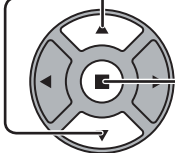
-  Press to select Set.
Press to store PRESENT TIME Setup.

Notes:

- Set cannot be selected unless PRESENT TIME is set.
- Unless setting the present time other than “99:99”, “DAY” and “PRESENT TIME” can not be set.
- The settings of “DAY” and “PRESENT TIME” are reset when leaving the display turned off for about 7 days for the following reasons:
Pressing  switch of the unit to turn off the display.
Disconnecting the AC cord.
Interruption of power supply.

Set up TIMER

Set the program for turning the power On/Off and select the input signal at the specified time. Up to 20 programs can be set.

[Setting Example]

Program 1, Every Monday, 12:00, Power On, Input: HDMI

Set up TIMER	
PRESENT TIME MON 0 : 03	
Program	1
Timer Function	On
Day	MON
Power Mode	Power On
Time	12 : 00
Input	HDMI

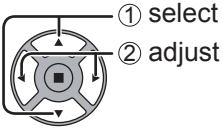

- 1 Set the program number.
- 2 To execute the program, set to "On".
The program is disabled when "Off" is set.
- 3 Set the day.
The program is executed every day when "Everyday" is set.
- 4 Set the power On/Off.
- 5 Set the time.
Pressing "◀" or "▶" button once changes "Time" 1 minute.
Pressing "◀" or "▶" button continuously changes "Time" by 15 minutes.
- 6 Set the input.

Notes:

- This function cannot be set unless "PRESENT TIME Setup" is set.
- If more than one programs are set for the same time, only the program with the smallest program number is enabled.

Screensaver (For preventing image retention)

Do not display a still picture, especially in 4:3 mode, for any length of time.

If the display must remain on, a Screensaver should be used.

When the screen saver is operating, the following 5 patterns are displayed full screen for 5 seconds each.

Black→Dark Gray→Gray→Light Gray→White

1  Press to display the Setup menu.

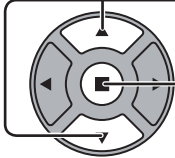
2  Press to select Screensaver.
Press to display Screensaver screen.

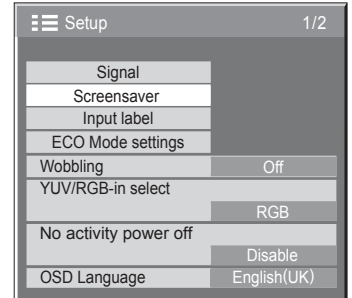

3 Mode selection

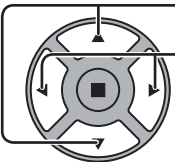
 Press to select Mode.
Press to select each mode items.

- Off
- Interval : Operates when Periodic Time and Operating Time are setup and those times arrive.
- Time Designation : Operates when Start Time and Finish Time are setup and those times arrive.
- Standby after SCR Saver: Operates while Screensaver duration, and display enters standby mode.
- On : Operates when Start is selected and the ACTION (■) button is pressed.

4 Start setting

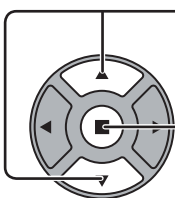
 When the Mode is set to On, press to select Start.
Press to start Screensaver.

The menu screen will disappear and the Screensaver will be activated. **To stop the Screensaver under On, press the R button or any buttons on the main unit.**

Note: When the display is turned off, the Screensaver will be deactivated.

Setup of Screensaver Time

After selecting Time Designation, Interval or Standby after SCR Saver, the relevant Time Setup will become available for selection and the Operating Time may be set. (Time cannot be set when “Mode” is “On” or “Off”.)

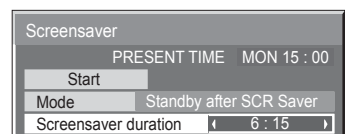
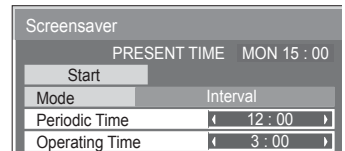
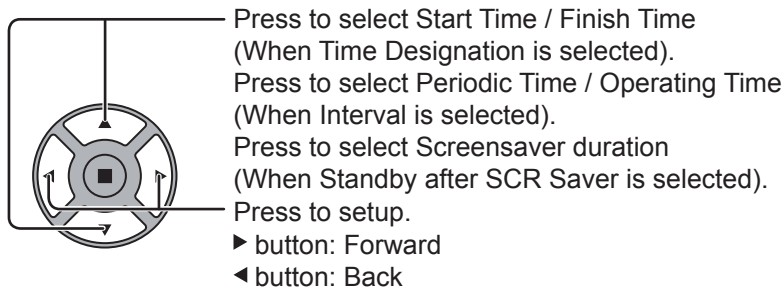

Notes:

- Pressing “◀” or “▶” button once changes the Time 1 minute.
[However, switching occurs every 15 minutes when Periodic Time is selected.]
- Pressing “◀” or “▶” button continuously changes the Time by 15 minutes.
- “Screensaver duration” of the “Standby after SCR Saver” can be set from 0:00 to 23:59. When this is set to “0:00”, “Standby after SCR Saver” will not be activated.

Note: Timer function will not work unless “PRESENT TIME” is set.

Wobbling

Automatically shifts the display image (therefore unnoticeable to the eye) to prevent image retention of sharper contour of image.

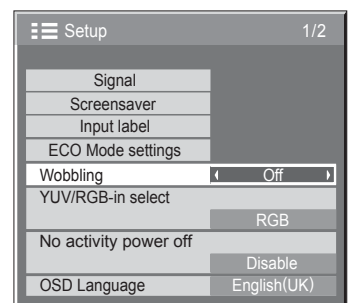
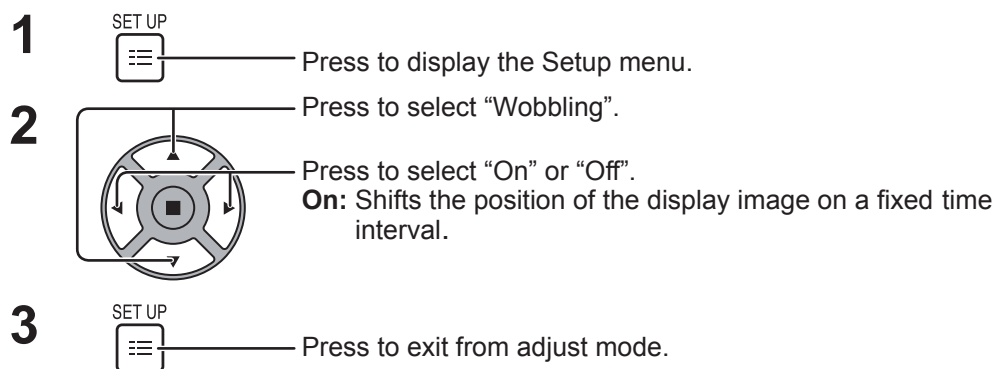

Notes:

- If “MULTI DISPLAY Setup” is set to “On”, this function does not operate.
- When this function is operating, part of the screen may appear to be missing.

No activity power off

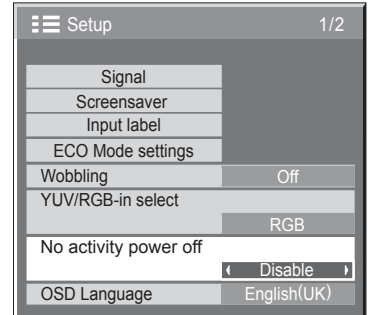
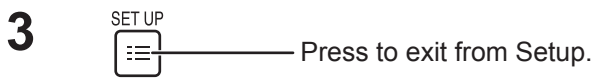
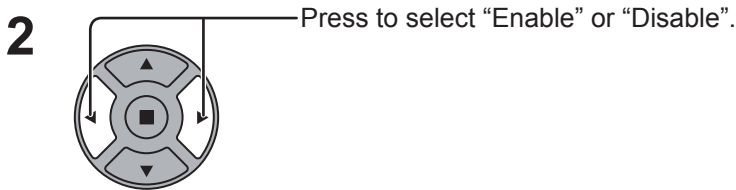
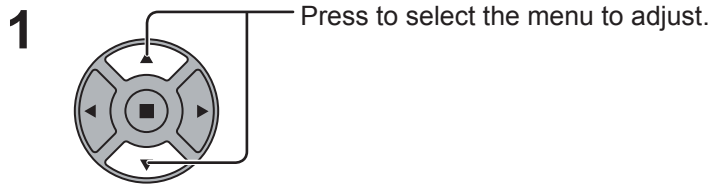

When this function is set to "Enable", the power is turned off (standby) automatically when there is no operation of the Display for 4 hours. Starting from 3 minutes before the turn off, the remaining time will be displayed.

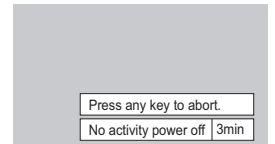



When the power is turned off due to this function, a message "Last turn off due to 'No activity power off'." is displayed next time the power is turned on.

Note:

During the screensaver is running, this function is disabled.

ECO Mode settings

Press , select "ECO Mode settings" in "Setup" menu and press  button.

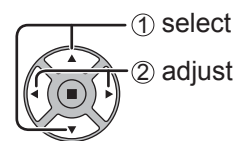
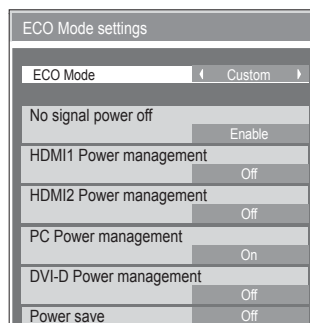

ECO Mode

Custom: The menu of power consumption reduction is individually set.

On: The following fixed values are set to the menu of power consumption reduction. Individual setting is not available.

No Signal power off: Enable
PC Power management: On
DVI-D Power management: On
Power save: Sensor

Using Remote Control

When  is pressed, the "ECO Mode" setting changes.

ECO Mode On

Custom settings

The menu of the power consumption reduction is individually set. This setting is enabled when "ECO Mode" is set to "Custom".

No signal power off

Equipment power supply is turned Off when there is no signal.

When this is set to "Enable", the power supply of the unit goes Off 10 minutes after the input signals stop.

HDMI1 Power management, HDMI2 Power management

When this function is set to On, it operates under the following conditions to turn the power on or off automatically.

When no pictures (sync signal) are detected for 30 or so seconds during HDMI1 or HDMI2 signal input:

→ Power is turned off (standby); the power indicator lights up orange.

When pictures (sync signal) are subsequently detected:

→ Power is turned on; the power indicator lights up green.

Notes:

- This function operates only during input from HDMI IN terminal.
- When the power indicator lights up orange, approx. 0.7 W of power is being consumed.

PC Power management

When this function is set to On, it operates under the following conditions to turn the power on or off automatically.

When no pictures are detected for 30 or so seconds during PC signal input:

→ Power is turned off (standby); the power indicator lights up orange.

When pictures are subsequently detected:

→ Power is turned on; the power indicator lights up green.

Notes:

- This function operates only during input from PC IN terminal.
- This function is effective when "Sync" is set to "Auto" and during normal viewing.

DVI-D Power management

When this function is set to On, it operates under the following conditions to turn the power on or off automatically.

When no pictures (sync signal) are detected for 30 or so seconds during DVI signal input:

→ Power is turned off (standby); the power indicator lights up orange.

When pictures (sync signal) are subsequently detected:

→ Power is turned on; the power indicator lights up green.

Notes:

- This function operates only during DVI signal input.
- When the power indicator lights up orange, approx. 0.7 W of power is being consumed.

Power save

This function adjusts the brightness of the backlight to reduce power consumption.

Off: This function does not operate.

On: Backlight brightness is reduced.



Sensor: The backlight brightness is automatically adjusted according to the viewing environment.

Note:

When this function is set to "On" or "Sensor", the "Backlight" setting in the Picture menu is disabled.

Customizing the Input labels

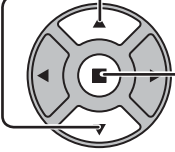
This function can change the label of the Input signal to be displayed. (see page 16)

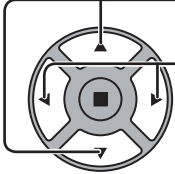
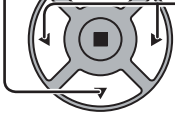
- 1  Press to display the Setup menu.
- 2  Press to select Input label.
 Press to display the Input label screen.
- 3  Press to select image input.
 Press to change input label.

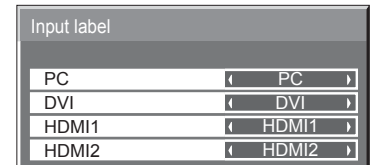
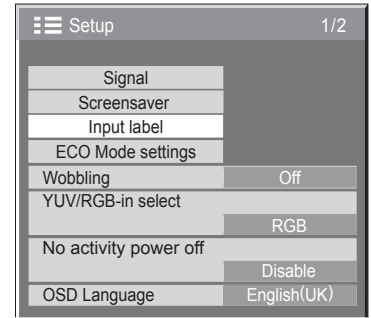

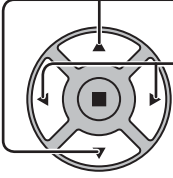
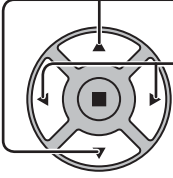

Image input
 [PC]
 [DVI]
 [HDMI1]
 [HDMI2]

Input label
 PC / DVD1 / DVD2 / DVD3 / Blu-ray1 / Blu-ray2 / Blu-ray3 / CATV / VCR / STB / (Skip)
 DVI / DVD1 / DVD2 / DVD3 / Blu-ray1 / Blu-ray2 / Blu-ray3 / CATV / VCR / STB / (Skip)
 HDMI1 / DVD1 / DVD2 / DVD3 / Blu-ray1 / Blu-ray2 / Blu-ray3 / CATV / VCR / STB / (Skip)
 HDMI2 / DVD1 / DVD2 / DVD3 / Blu-ray1 / Blu-ray2 / Blu-ray3 / CATV / VCR / STB / (Skip)

(Skip): The INPUT button press will skip its input.

Selecting the On-Screen Menu Language

-  Press to display the Setup menu.
-  Press to select the OSD Language.
 Press to select your preferred language.

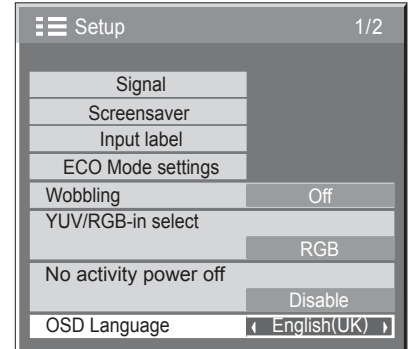

■ Selectable languages

- English (UK)
- ↕
- Deutsch
- ↕
- Français
- ↕
- Italiano
- ↕
- Español
- ↕
- ENGLISH (US)
- ↕
- 中文.....(Chinese)
- ↕
- 日本語.....(Japanese)
- ↕
- Русский.....(Russian)

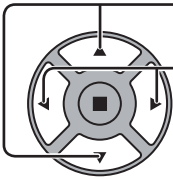
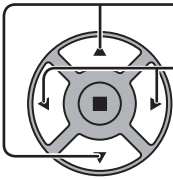
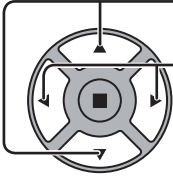
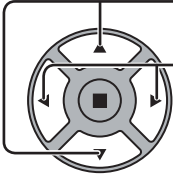

Customizing the On-Screen Menu Display

Set the display time and background transparency of the on-screen menu display.

-  Press to display the Setup menu.
-  Press to select "Menu Display Duration".
 Press to adjust the display duration.
-  Press to select "Menu Transparency".
 Press to adjust the transparency.
-  Press to exit from adjust mode.

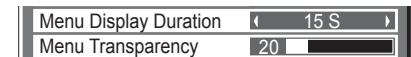

Setup for MULTI DISPLAY

By lining up the Displays in groups, for example, as illustrated below, an enlarged picture may be displayed across all screens.

For this mode of operation, each display has to be set up with a Display number to determine its location.

(Example)

group of 4 (2 × 2)

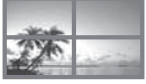

group of 9 (3 × 3)



group of 16 (4 × 4)





group of 25 (5 × 5)

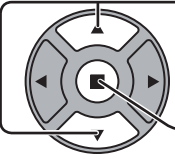
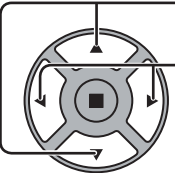

How to Setup MULTI DISPLAY

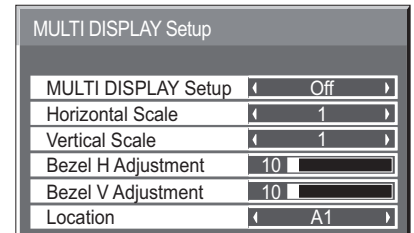
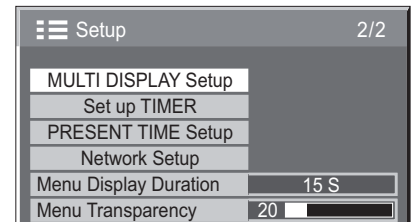
- 1  Press to display the Setup menu.
- 2  Press to select the MULTI DISPLAY Setup.
Press to display the "MULTI DISPLAY Setup" menu.
- 3  Press to select the MULTI DISPLAY Setup.
Press to select "On" or "Off".



Item	Details
MULTI DISPLAY Setup	Select "On" or "Off".
Horizontal Scale	Select "1", "2", "3", "4", "5".
Vertical Scale	Select "1", "2", "3", "4", "5".
Bezel H Adjustment Bezel V Adjustment	<p>Areas of the image that are hidden by the joint sections are adjusted both horizontally and vertically (0~100).</p> <div style="display: flex; justify-content: space-around;"> <div style="text-align: center;"> <p>To show joints between displays.</p>  <p>Example</p> <p>Suitable for still image display. Setting value: 0</p> </div> <div style="text-align: center;"> <p>To hide joints between displays.</p>  <p>Example</p> <p>Suitable for moving image display. Setting value: 100</p> </div> </div>

Setup for MULTI DISPLAY

Item	Details																																																									
Location	<p>Select the required arrangement number. (A1-E5 : Refer to the following) Display Number locations for each arrangement. (Examples)</p> <p>(2 × 1) (2 × 3) (4 × 2) (4 × 4) (5 × 5)</p> <table style="display: inline-table; margin-right: 10px;"> <tr><td>A1</td><td>A2</td></tr> </table> <table style="display: inline-table; margin-right: 10px;"> <tr><td>A1</td><td>A2</td></tr> <tr><td>B1</td><td>B2</td></tr> <tr><td>C1</td><td>C2</td></tr> </table> <table style="display: inline-table; margin-right: 10px;"> <tr><td>A1</td><td>A2</td><td>A3</td><td>A4</td></tr> <tr><td>B1</td><td>B2</td><td>B3</td><td>B4</td></tr> </table> <table style="display: inline-table; margin-right: 10px;"> <tr><td>A1</td><td>A2</td><td>A3</td><td>A4</td></tr> <tr><td>B1</td><td>B2</td><td>B3</td><td>B4</td></tr> <tr><td>C1</td><td>C2</td><td>C3</td><td>C4</td></tr> <tr><td>D1</td><td>D2</td><td>D3</td><td>D4</td></tr> </table> <table style="display: inline-table;"> <tr><td>A1</td><td>A2</td><td>A3</td><td>A4</td><td>A5</td></tr> <tr><td>B1</td><td>B2</td><td>B3</td><td>B4</td><td>B5</td></tr> <tr><td>C1</td><td>C2</td><td>C3</td><td>C4</td><td>C5</td></tr> <tr><td>D1</td><td>D2</td><td>D3</td><td>D4</td><td>D5</td></tr> <tr><td>E1</td><td>E2</td><td>E3</td><td>E4</td><td>E5</td></tr> </table>	A1	A2	A1	A2	B1	B2	C1	C2	A1	A2	A3	A4	B1	B2	B3	B4	A1	A2	A3	A4	B1	B2	B3	B4	C1	C2	C3	C4	D1	D2	D3	D4	A1	A2	A3	A4	A5	B1	B2	B3	B4	B5	C1	C2	C3	C4	C5	D1	D2	D3	D4	D5	E1	E2	E3	E4	E5
A1	A2																																																									
A1	A2																																																									
B1	B2																																																									
C1	C2																																																									
A1	A2	A3	A4																																																							
B1	B2	B3	B4																																																							
A1	A2	A3	A4																																																							
B1	B2	B3	B4																																																							
C1	C2	C3	C4																																																							
D1	D2	D3	D4																																																							
A1	A2	A3	A4	A5																																																						
B1	B2	B3	B4	B5																																																						
C1	C2	C3	C4	C5																																																						
D1	D2	D3	D4	D5																																																						
E1	E2	E3	E4	E5																																																						







4  Press to exit from adjust mode.

ID Remote Control Function

You can set the remote control ID when you want to use this remote control on one of several different displays.

Note:

To operate this function, please purchase ID remote controller sold separately.
 Object model : EUR7636090R (Europe)
 EUR7636070R (Other countries)

- 1** Switch  to  on the right side.
- 2** Press the  button on the remote control.
- 3** Press one of ,  for the tens digit setting.
- 4** Press one of ,  for the units digit setting.

Notes:

- The numbers in 2, 3 and 4 should be set up quickly.
- Adjustable ID number range is 0 - 99.
- If a number button is pressed more than two times, the first two numbers become the ID number for the remote control.

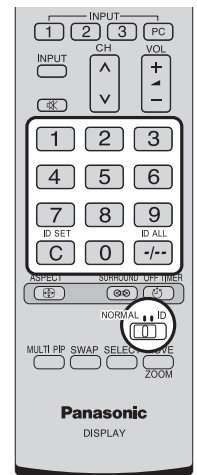

ID remote control button operation

The operation is the same as normal remote control except for the  button.

ID Cancellation

Press  button on remote control. (This has the same effect as pressing the , ,  buttons at the same time.)

Notes:

- Set the Remote ID “On” to operate the ID remote control.
 If Remote ID is set to “On”, you can use the remote control without identical ID number during option menu display. (see page 44)
- The ID remote control cannot be used when ID select is set to anything other than 0, and the remote control ID is not the same as the ID select number (see page 44).

Setup for Input Signals

YUV / RGB-IN select

Select to match the signals from the source connected to DVI-D IN terminal.

YUV signals ⇔ "YUV"

RGB signals ⇔ "RGB"

1  Press to display the Setup menu.

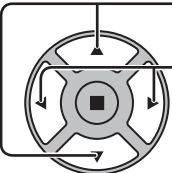
2  Press to select the "YUV/RGB-in select".
Press to select the desired mode.
YUV ← → RGB



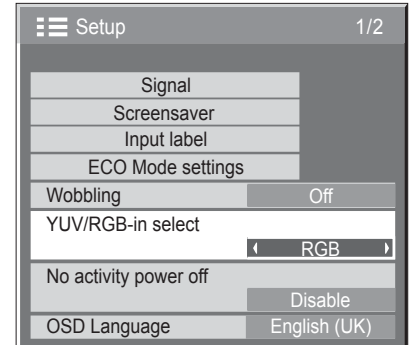

3  Press to exit from adjust mode.



Signal menu

Note:

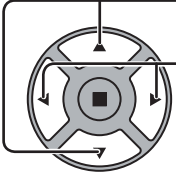
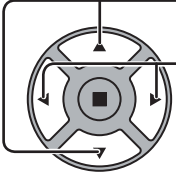
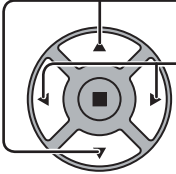
“Signal” setup menu displays a different setting condition for each input signal.

-  Press to display the Setup menu.
-  Press to select the “Signal”.
 Press to display the Signal menu.
-  Press to select the menu to adjust.
 Press to adjust the menu.
-  Press to exit from adjust mode.

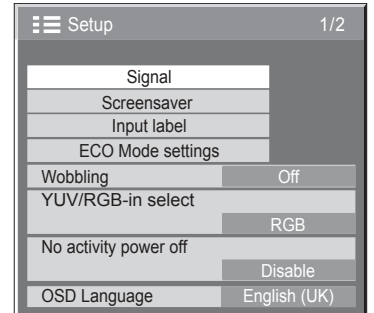

↓ Press ACTION (■) button

For RGB

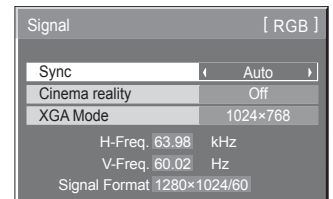

For Digital

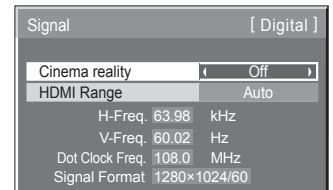

Cinema reality

Cinema reality:

When on, the display attempts to reproduce a more natural interpretation of sources such as movie pictures, which are recorded at 24 frames per second. If the picture is not stable, turn the setting to off.

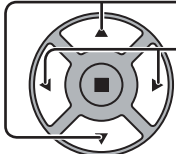
- 
- Press to select Cinema reality.
 - Press to set On / Off.



XGA Mode

This menu is displayed when the input signal is analog. This menu sets two types of XGA signals with 60Hz vertical frequency having different aspect ratios and sampling rates (1,024 × 768 @ 60Hz and 1,366 × 768 @ 60Hz). When a 1,280 × 768 @ 60Hz input signal is automatically detected, the image is processed as a 1,280 × 768 @ 60Hz XGA input signal irrespective of this setting.

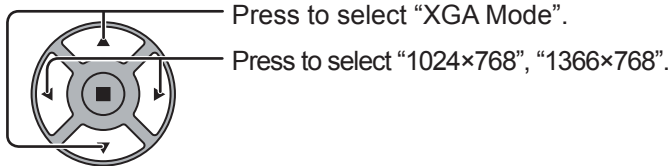

Note:

After making this setting, be sure to make each adjustment (such as “Auto Setup”) on the “Pos. /Size” menu as necessary. (see page 22)

Sync

This function operates only during input from PC IN terminal.

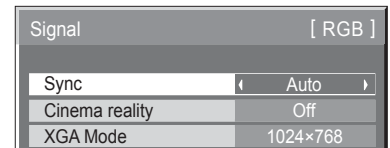
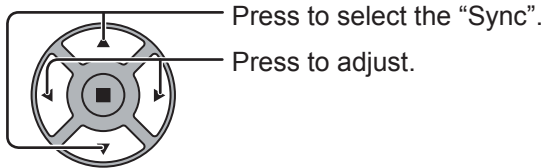

Confirm that the input is set to RGB input (this setting is valid only for RGB input signal).

Auto: The H and V sync or synchronized signal is automatically selected. If both input, it is selected the H and V sync. However, the synchronized signal that is input first is selected.



on G: Uses a synchronized signal on the Video G signal, which is input from the G connector.

HDMI Range

Switches the dynamic range according to the input signal from HDMI terminal.

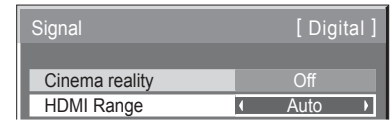
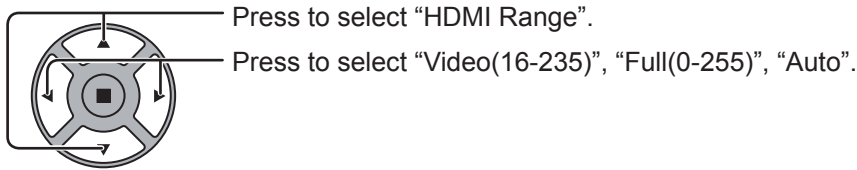

Video(16-235): If the input signal is the video range, Example: HDMI terminal output for DVD player

Full(0-255): If the input signal is full range, Example: HDMI terminal output for personal computer

Auto: Switches the dynamic range automatically between "Video(16-235)" and "Full(0-255)" according to the input signal.

Note:

This function can be set to the HDMI signal.

Input signal display

Displays the frequency and the type of the current input signal.

Display range(PC input signal):

Horizontal 30 - 110 kHz
Vertical 48 - 120 Hz

The dot clock frequency is displayed during digital signal input.

Note:

The automatically detected signal format may be displayed differently than the actual input signal.

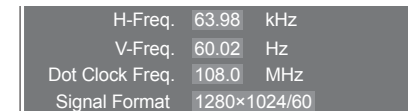
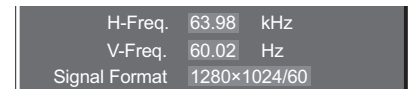

Network Setup

Configure the various settings required to use the network function.

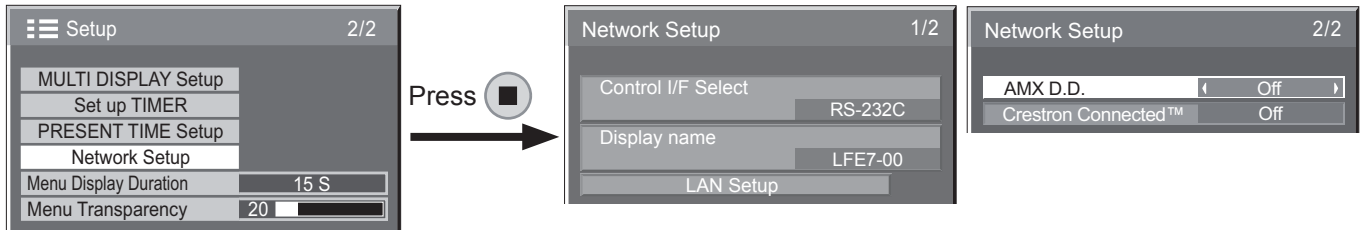

■ Control I/F Select

Set whether to control with RS-232C or LAN. When “LAN” is set, power indicator lights orange under the condition of power off with remote control (stand-by state).

Note:

When the power indicator lights up orange, 6 W of power is being consumed.

■ Display Name

The name of the Display that is shown on the network can be changed.

■ LAN Setup

See page 42

■ AMX D.D.

This function allows the Display to be detected by AMX Device Discovery. For more details, visit the following website.

<http://www.amx.com/>

■ Crestron Connected™

When this function is set to on, the Display can be monitored or controlled via the network using equipment and application software of Crestron Electronics, Inc.

This Display supports the following application software from Crestron Electronics, Inc.

- RoomView® Express
- Fusion RV®
- RoomView® Server Edition

[Crestron Connected™] is a function to connect to a system developed by Crestron Electronics, Inc. which manages and controls multiple system devices connected to the network.

- For details of “Crestron Connected™”, refer to the Crestron Electronics, Inc. website (Provided only in English).

<http://www.crestron.com/>

For the download of “RoomView® Express”, refer to the Crestron Electronics, Inc. website (Provided only in English).

<http://www.crestron.com/getroomview>

Network Setup

LAN Setup

Detailed network settings for the LAN established via the LAN terminal of the Display or twisted pair cable transmitter can be configured.

Select "LAN Setup" and press .

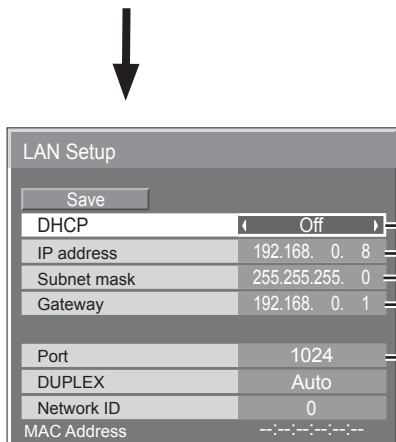





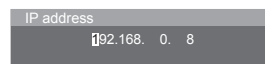

DHCP, IP address, Subnet mask, and Gateway settings

1 Set DHCP.
When "Off" is selected, IP address and other settings can be set manually.

2 Select the item and press .

3 Enter an address.



- ① Use   to select a digit.
- ② Use   to change a number.
- ③ Press .

Pressing  will cancel the address change.





4 Select "Save" and press .

Port setting

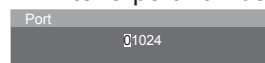
1 Select "Port" and press .

2 Enter a port number.



- ① Use   to select a digit.
- ② Use   to change a number.
- ③ Press .

Pressing  will cancel the port number change.

Save

Save the current network Setup. Each value set for DHCP, IP address, Subnet mask, and Gateway will be saved. If "NG" is displayed, check the same IP address is not used within the same network.

DHCP (DHCP client function)

To obtain an IP address automatically using a DHCP server, set this to "On". If DHCP server is not used, set this to "Off".

IP address (IP address display and setting)

Enter an IP address if DHCP server is not used.

Subnet mask (Subnet mask display and setting)

Enter a subnet mask if DHCP server is not used.

Gateway (Gateway address display and setting)

Enter a gateway address if DHCP server is not used.

Port

Set the port number used for command control.

The available setting range is 1024 – 65535.

When the PLink™ protocol is used, the port setting is not necessary.

DUPLEX

Set the connection speed of the LAN environment.

Select the value from Auto, 10 HALF, 10 FULL, 100 HALF or 100 FULL.

Network ID

Set the ID to identify this unit.

The available setting range is 0 – 99.







MAC Address

Display the MAC address of this unit. However, the MAC address is not displayed when the "Control I/F Select" is set to "RS-232C".

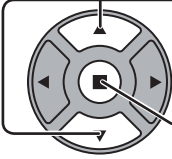
Notes:

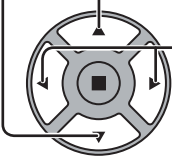

- To use a DHCP server, make sure the DHCP server is started.
- Contact your network administrator for details on settings.

Options Adjustments

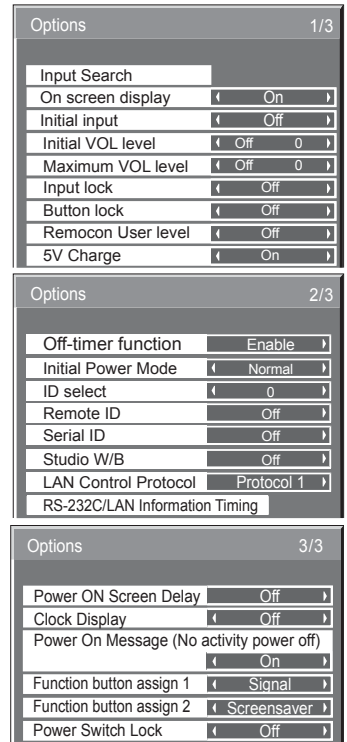
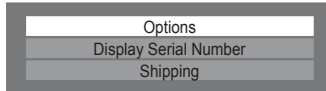

























- 1  Press to display the SET UP menu.
- 2  Press to select "OSD Language".
 Press for more than 3 seconds.
- 3  Press to select "Options".
 Press to display the Options menu.
- 4  Press to select your preferred menu.
 Press to adjust the menu.
- 5  Press to exit from Options menu.



• The serial number of this device is displayed when "Display Serial Number" is selected in step 3.

Item	Adjustments
Input Search	Set auto input switching for when there is no signal. (see page 45)
On screen display	<p>On: Displays all the following on screen.</p> <ul style="list-style-type: none"> • Power on display • Input signal switch display • No signal display • Mute and the remaining time of off-timer after RECALL was pressed. <p>Off: Hides all the items above from view.</p>
Initial input	<p>Adjusts the input signal when the unit is turned on.</p> <p>Off ↔ PC ↔ DVI ↔ HDMI1 ↔ HDMI2</p> <p>Notes:</p> <ul style="list-style-type: none"> • Only the adjusted signal is displayed. (see page 16) • This menu is available only when "Input lock" is "Off".
Initial VOL level	<p>Press  button to adjust the volume when the unit is turned on.</p> <p>Off ↔ On</p> <p>Off: Sets normal volume.</p> <p>On: Sets your preferred volume.</p> <p>Notes:</p> <ul style="list-style-type: none"> • When "Maximum VOL level" is "On", the volume can only be adjusted between 0 and your maximum range. • You can hear the changed volume regardless of your volume setting before opening the options menu if you adjust the volume when "Initial VOL level" is "On" and cursor is on the menu.
Maximum VOL level	<p>Press  button to adjust the maximum volume.</p> <p>Off ↔ On</p> <p>Off: Sets auto maximum volume.</p> <p>On: Sets your preferred maximum volume.</p> <p>Notes:</p> <ul style="list-style-type: none"> • If the "Maximum VOL level" is set lower than the "Initial VOL level", the "Initial VOL level" automatically becomes the same as the "Maximum VOL level". • The volume display can go up to 100 regardless of the settings. • You can hear the changed volume regardless of your volume setting before opening the options menu if you adjust the volume when "Maximum VOL level" is "On" and cursor is on the menu.
Input lock	<p>Locks the input switch operation.</p> <p>Off ↔ PC ↔ DVI ↔ HDMI1 ↔ HDMI2</p> <p>Notes:</p> <ul style="list-style-type: none"> • Only the adjusted signal is displayed (see page 16). • Input switch can be used when this is set to "Off".

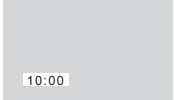

Options Adjustments

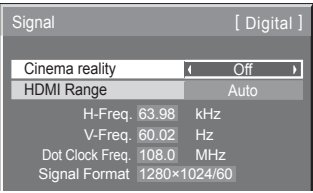
Item	Adjustments
<p>Button lock</p>	<p>Off ↔ On ↔ MENU&ENTER Off: All the buttons on main unit can be used. MENU&ENTER: Locks  and  buttons on main unit. On: Locks all the button on main unit except the Power switch. Sets Button lock with the unit buttons in the following procedure. Off: Press  four times → Press  four times → Press  four times → Press   MENU&ENTER: Press  four times → Press  four times → Press  four times → Press   On: Press  four times → Press  four times → Press  four times → Press  </p>
<p>Remocon User level</p>	<p>Off ↔ User1 ↔ User2 ↔ User3 Off: You can use all of the buttons on the remote control. User1: You can only use , , , ,  buttons on the remote control. User2: You can only use  button on the remote control. User3: Locks all the buttons on remote control.</p>
<p>5V Charge (CHARGE terminal power supply setting)</p>	<p>Sets the power supply from the CHARGE terminal. On: Supplies power when the power of the display is on. Off: Supplies no power. Note: Power will not be supplied in standby mode even if “5V Charge” is set to “On”.</p>
<p>Off-timer function</p>	<p>Enable: Enables the “Off-timer function”. Disable: Disables the “Off-timer function”. Note: When “Disable” is set, the Off-timer is cancelled.</p>
<p>Initial Power Mode</p>	<p>Normal ↔ On ↔ Standby Sets the power mode of the unit for when the power recovers from failure or after plugging off and in again. Normal: Power returns in as the same state as before the power interruption. Standby: Power returns in standby mode. (Power Indicator : red/orange) On: Power returns in power On. (Power Indicator : green) Note: When using multiple displays, “Standby” is preferred to be set in order to reduce a power load.</p>
<p>ID select</p>	<p>Sets panel ID number when panel is used in “Remote ID” or “Serial ID”. Set value range: 0 - 100 (Standard value: 0)</p>
<p>Remote ID</p>	<p>The setting of this menu is valid only when using ID remote control. Off: Disables ID remote control functions. You can use normal remote control operations. On: Enable ID remote control functions. Note: To use the ID remote control function, it is necessary to set each ID number of remote control and display unit. About the setting method, please refer to “ID Remote Control Function” (see page 36) and “ID select” (above-mentioned).</p>
<p>Serial ID</p>	<p>Sets the panel ID Control. Off: Disables external control by the ID. On: Enables the external control by the ID.</p>
<p>Studio W/B</p>	<p>Off: Nullify all the settings adjusted. On: Sets the colour temperature for TV studio. Note: Valid only when the “Warm” is set as “White balance” in Picture menu.</p>
<p>LAN Control Protocol</p>	<p>Select the LAN control protocol. Protocol 1: Control with the Panasonic Display sequence. Protocol 2: Control with the sequence that compatible with Panasonic Projector.</p>
<p>RS-232C/LAN Information Timing</p>	<p>Set up the informing manner if error warning occurred. (see page 46)</p>
<p>Power ON Screen Delay</p>	<p>Off ↔ 1 ↔ 2 ↔ 3... ↔ 30 You can set the power-on delay time of the displays to reduce the power load, when you press  to turn on the multiple displays that are set together, for example, on MULTI DISPLAY system. Set each display’s setting individually. Off: The display will be turned on at the same time as  is pressed. 1 to 30 (sec.): Set the power-on delay time (second). After pressing , the display will be powered on with time delay depending on this setting. Notes: • During this function is working, the power indicator is blinking green. • This function also works when the power recovers from failure or after plugging off and in again the power cord.</p>
<p>Power On Message (No activity power off)</p>	<p>Whether to show/hide No activity power off Precautions at the time of power ON is set. On: The warning precautions are shown at the time of power ON. Off: The warning precautions are not shown at the time of power ON. Note: This setting is enabled only if “No activity power off” is “Enable” (see page 31).</p>
<p>Clock Display</p>	<p>Off: Not display the clock. On: Display the clock. The clock is displayed at the lower left of the screen when  button is pressed. Note: When “PRESENT TIME Setup” is not set, the clock is not displayed even if “Clock Display” is “On”. (see page 27)</p> 

Item	Adjustments
<p>Function button assign 1 Function button assign 2</p>	<p>Set the functions that operates when FUNCTION 1 2 is pressed. Signal: The "SIGNAL" menu is displayed. Screensaver: The "SCREENSAVER" menu is displayed. ECO menu: The "ECO MODE SETTINGS" menu is displayed. Set up TIMER: The "Set up TIMER" menu is displayed. Note: Factory settings are as follows. FUNCTION1 button: Signal FUNCTION2 button: Screensaver</p> <p>Use the FUNCTION button</p> <p>The menu screen is displayed. (Example: Signal)</p>  <p>Press the FUNCTION button to exit from the menu.</p>
<p>Power Switch Lock</p>	<p>Sets the lock setting for the display Power switch. On: Power switch operation is disabled. Off: Power switch operation is enabled. Note: This function is only for TH-42LFE7U, TH-50LFE7U, TH-65LFE7U.</p>

Normalisation

When both main unit buttons and remote control are disabled due to the "Button lock", "Remocon User level" or "Remote ID" adjustments, set all the values "Off" so that all the buttons are enabled again.

Press the  button on main unit together with  button on the remote control and hold for more than 5 seconds. The "Shipping" menu is displayed and the lock is released when it disappears.

Input Search

When a signal is not detected, another input with a signal is automatically selected.

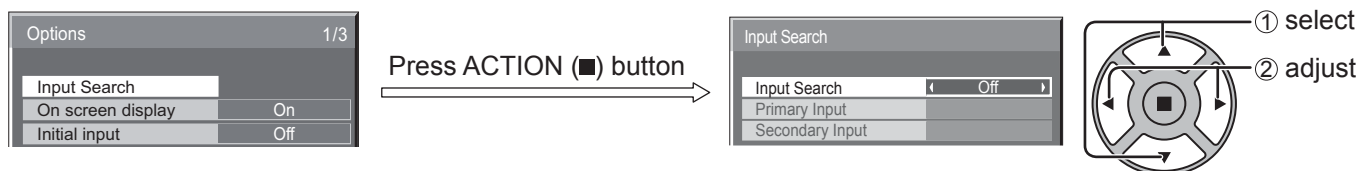

Input Search

Off: When there is no signal, the input is not switched automatically.

All Inputs: Searches all inputs and switches to an input with a signal.

Priority: Searches "Primary Input" and "Secondary Input" in order and switches to an input with a signal.

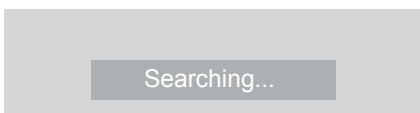

"Searching..." is displayed during the input search.

Primary Input, Secondary Input

Set the input to search when "Priority" is selected.

(NONE) ↔ PC ↔ DVI ↔ HDMI1 ↔ HDMI2

Note:

This menu is available only when "Input lock" is "Off". (see page 43)

RS-232C/LAN Information Timing

Set up the informing manner for no signal or temperature rising.

While RS-232C controls: Warning or error message sent on the display automatically.

While LAN controls: Acquire the warning or error message from the display.

Options 2/3	
Off-timer function	Enable
Initial Power Mode	Normal
ID select	0
Remote ID	Off
Serial ID	Off
Studio W/B	Off
LAN Control Protocol	Protocol 1
RS-232C/LAN Information Timing	

Press ACTION (■) button



RS-232C/LAN Information Timing	
No Signal Warning	On
No Signal Warning Timing	5min
No Signal Error	On
No Signal Error Timing	10min
Temperature Warning	On
Temperature Warning Value	55°C
Temperature Warning Release Value	52°C

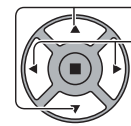

- ① select
- ② adjust

■ No Signal Warning

If set to “On”, the display sends out the no signal warning.

■ No Signal Warning Timing

Set up the detecting time for no signal warning.

■ No Signal Error

If set to “On”, the display sends out the no signal error.

■ No Signal Error Timing

Set up the detecting time for no signal error.

The warning of “No Signal Warning” and the error of “No Signal Error” are not sent when the no signal state is detected through any of the following functions:

No Signal power off: Enable, PC Power management, DVI-D Power management, HDMI1 Power management, HDMI2 Power management (see page 32)

Setting Example

No Signal Warning Timing: 5 minutes

No Signal Error Timing: 10 minutes

PC Power management: On (30 seconds)

If there is no signal when PC IN is input, “PC Power management” is activated first and the Display enters the standby mode.

Note:

The “No Signal Error Timing” cannot be set shorter than “No Signal Warning Timing”.

■ Temperature Warning

If set to “On”, the display sends out the warning temperature.

■ Temperature Warning Value

Set up the detecting temperature for temperature warning.

■ Temperature Warning Release Value

Set up the temperature to release the temperature warning.

Using Network Function

Network Connection

This unit has a network function to control the network connected display with your computer.

Note:

To use the network function, set each “Network Setup” setting and make sure to set the “Control I/F Select” to “LAN”. (see page 41)

When “LAN” is set, power indicator lights orange under the condition of power “Off” with remote control (stand-by state).

Example of network connection

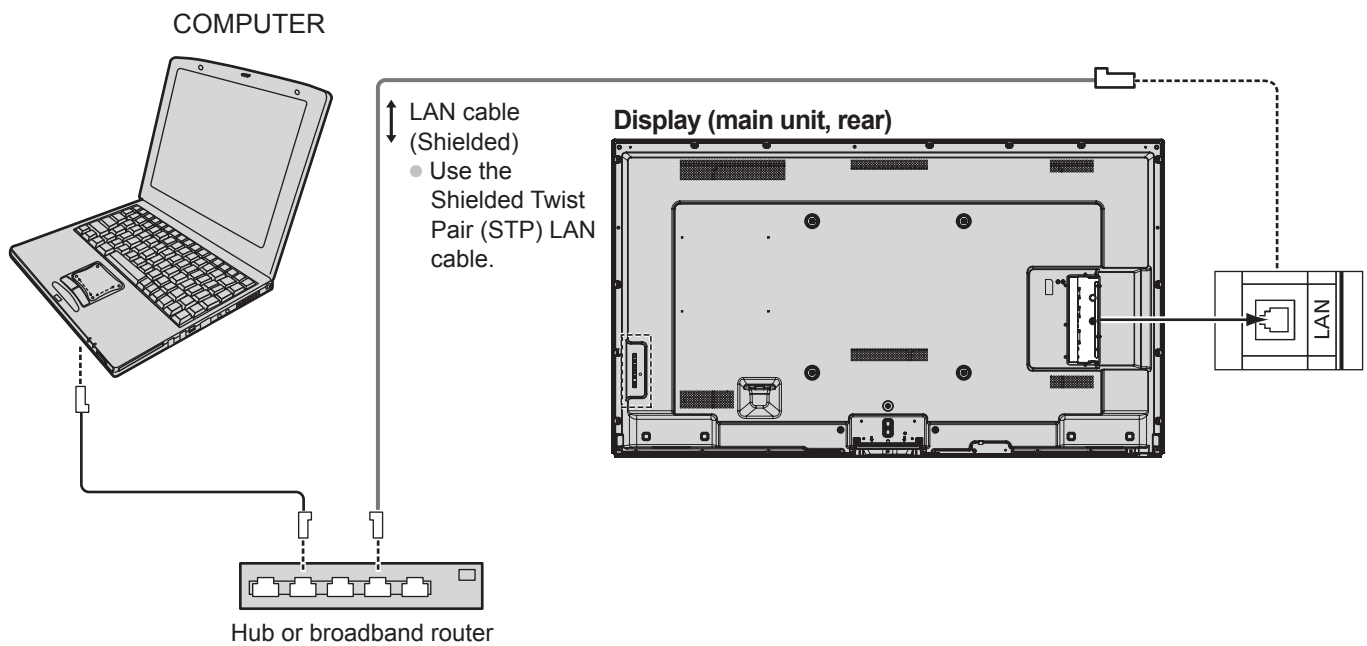

Notes:

- Make sure the broadband router or hub supports 10BASE-T/100BASE-TX.
- Use a LAN cable that is compliant with “CAT5” when connecting a device that supports 100BASE-TX.
- For instructions on how to connect, consult your network administrator.

Using Web Browser Control

You can use a Web browser to control the unit and set up a network and password.

Before Using Web Browser Control

To use the Web browser control, the unit and computer setups are required.

Unit Setup

Set each “Network Setup” setting and make sure to set the “Control I/F Select” to “LAN”. (see page 41, 42)

Computer Setup

Disable the proxy server settings and enable JavaScript.

(Windows)

Disable proxy server settings

- 1 Display [Internet Properties] window.
Click [Start] – [Control Panel] – [Network and Internet] – [Internet Options].
- 2 Click the [Connections] tab and then [LAN Settings].
- 3 Deselect the [Use automatic configuration script] and [Use a proxy server for your LAN] boxes.
- 4 Click [OK].

Enable JavaScript

- 1 Display [Internet Properties] window.
Click [Start] – [Control Panel] – [Network and Internet] – [Internet Options].
- 2 Set the security level on the [Security] tab to [Default Level]. Alternatively enable [Active scripting] from the [Custom Level] button.

(Macintosh)

Disable proxy server settings

- 1 From the [Safari] menu, click [Preferences].
General screen is displayed.
- 2 From the [Advanced] tab, click the [Change Settings...] button next to [Proxies]. Click [Proxies] and set up a proxy server.
- 3 Deselect the [Web Proxy] and [Automatic Proxy Configuration] boxes.
- 4 Click [Apply Now].

Enable JavaScript

- 1 Display [Security] of Safari.
- 2 Select [Enable JavaScript] under [Web content].

Access from Web Browser

Access to the TOP screen of the Web browser control using a Web browser.

- 1 Start your Web browser.
- 2 Enter the IP address set with the “LAN Setup” of the unit.
(see page 42)

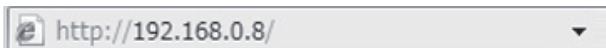

- 3 Enter the user name and password when the Authentication screen is displayed.

Authentication screen

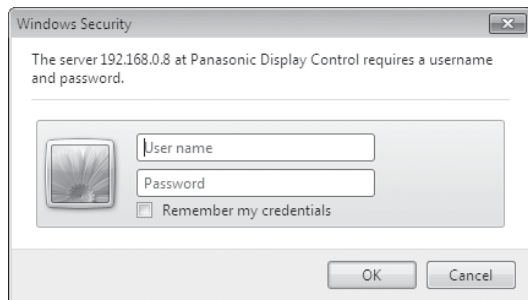

- 4 Click [OK].
After logged in, the TOP screen of the Web browser control is displayed. (see page 50)

Notes:

- The password used here is the same password used for command control and the PJLink™ security authentication.
- Default user name and password are as follows:
User name: user1
Password: panasonic
- The password can be changed on the Password Setup screen after logging in (see page 51). The user name cannot be changed.
- Under no circumstances, Panasonic Corporation or its associated companies will ask customers their password directly.
Even if you are asked directly, please do not reveal your password.

Using Web Browser Control

TOP screen structure of the Web browser control

After logging in, the TOP screen of the Web browser control is displayed.

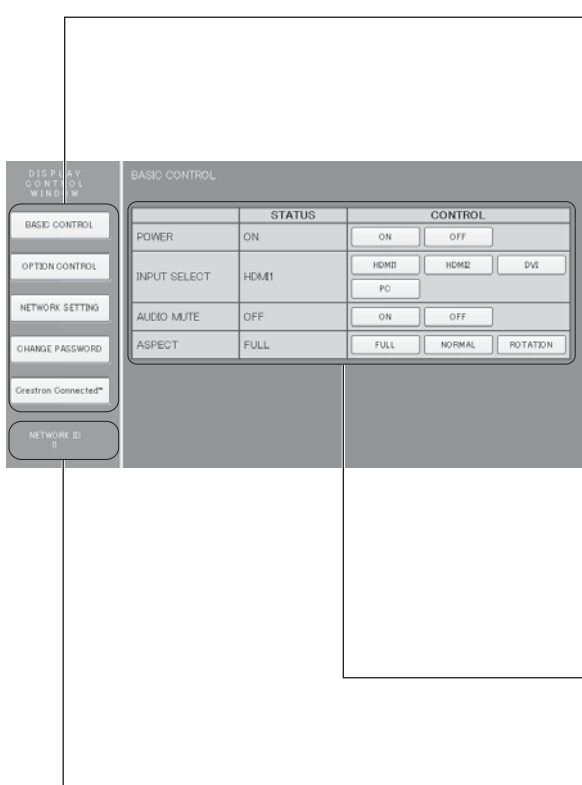

① **Menu**

Menu items are displayed. When a button is clicked, setup screen of each item is displayed.

Item	Details
BASIC CONTROL	BASIC CONTROL screen is displayed. (see below)
OPTION CONTROL	OPTION CONTROL screen is displayed. (see below)
NETWORK SETTING	Network Setup screen is displayed. (see page 51)
CHANGE PASSWORD	Password setup screen is displayed. (see page 51)
Crestron Connected™	The Crestron Connected™ operations screen will appear. (see pages 52, 53) <ul style="list-style-type: none"> This button does not appear when “Crestron Connected™” in “Network Setup” is “OFF”. (see page 41)

② According to the selected item from the menu, setup status or set items are displayed.

③ **Network ID information**

ID to identify the unit is displayed.

Display Control (BASIC CONTROL/OPTION CONTROL Screen)

Click BASIC CONTROL or OPTION CONTROL from the menu. Various controls of the unit can be set.

BASIC CONTROL screen

Click BASIC CONTROL from the menu. Unit status and buttons to change settings are displayed.

	STATUS	CONTROL
POWER	ON	ON OFF
INPUT SELECT	HDMI1	HDMI1 HDMI2 DVI PC
AUDIO MUTE	OFF	ON OFF
ASPECT	FULL	FULL NORMAL ROTATION

Item	Details
POWER	Switch ON/OFF of the unit power.
INPUT SELECT	Switch the input signals. Displayed buttons vary according to the connection status of the video device.
AUDIO MUTE	Switch ON/OFF of the sound mute.
ASPECT	Switch the screen modes

OPTION CONTROL screen

Click OPTION CONTROL from the menu. Command input field for command control of the unit is displayed.



Item	Details
COMMAND	Enter a command. Use the same command used for the serial control. (see page 12)
RESPONSE	Response from the unit is displayed.
SEND	Command is sent and run.

Note:

After the settings are changed, it may take a while till the display's response is displayed.

NETWORK SETTING (NETWORK SETTING Screen)

Click NETWORK SETTING from the menu. Various settings of a network can be set. For the details of the setting items, please check LAN Setup under the Network Setup of the unit. (see page 42)

DHCP	<input type="radio"/> OFF <input type="radio"/> ON
IP ADDRESS	192.168.0.100
SUBNET MASK	255.255.255.0
GATEWAY	192.168.0.1
PORT	1024
LAN SPEED	<input checked="" type="radio"/> AUTO <input type="radio"/> 10 HALF <input type="radio"/> 10 FULL <input type="radio"/> 100 HALF <input type="radio"/> 100 FULL
NETWORK ID	0

Notes:

- To use a DHCP server, make sure the DHCP server is started.
- During a DHCP server is used, IP ADDRESS, SUBNET MASK, and GATEWAY values cannot be entered.
- When the set values are changed properly, "NETWORK SETTING CHANGED." message and the changed set items are displayed.

Item	Details
DHCP	Set to ON when a DHCP server is used, or OFF when it is not used.
IP ADDRESS	Enter an IP address.
SUBNET MASK	Enter a subnet mask.
GATEWAY	Enter a gateway address.
PORT	Enter the port number used for command control. The available setting range is 1024 - 65535.
LAN SPEED	Set the connection speed of the LAN environment.
NETWORK ID	Set the ID to identify this unit. The available setting range is 0 - 99.
SAVE	Save the each set value.

Password Setting (CHANGE PASSWORD Screen)

Click CHANGE PASSWORD from the menu. Password to access the Web browser control can be set. When the password is changed in this screen, the password used for command control and the PJLink™ security authentication is also changed.

OLD PASSWORD
NEW PASSWORD
NEW PASSWORD (RETYPE)

Notes:

- The default password is "panasonic".
- Up to 32 alphanumeric characters can be used for a password.
- When the password is changed properly, "Password has changed." message is displayed.

Item	Details
OLD PASSWORD	Enter the old password.
NEW PASSWORD	Enter the new password.
NEW PASSWORD (RETYPE)	Enter the password entered in "NEW PASSWORD" for confirmation.
SAVE	Save the new password. The confirmation screen is displayed. Click OK to change the password.

Crestron Connected™ page

You can monitor or control the Display using Crestron Connected™.

When you click [Crestron Connected™], the Crestron Connected™ operation page is displayed.

If Adobe Flash Player is not installed in your computer, or if the browser does not support Flash, this page does not appear. In this case, return to the previous page by clicking [Back] in the operation page.

Operation page

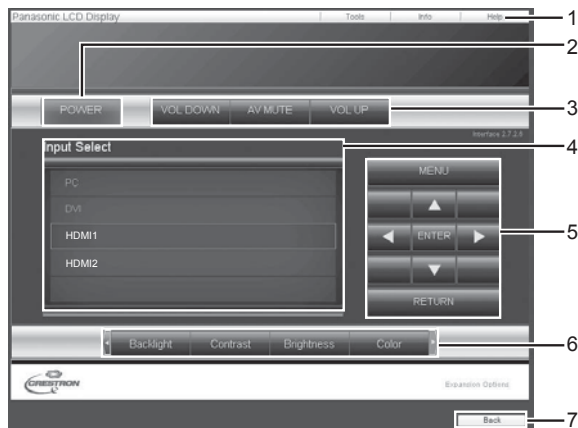

1 Tools, Info, Help

Switches the pages for tools, information, help using the tab.

2 POWER

Switches between on and off of the power.

3 VOL DOWN, AV MUTE, VOL UP

Sets the volume, AV mute. When the power of the Display is turned off, VOL DOWN, AV MUTE and VOL UP are not available.

4 Input Select

Sets the input selection. When the power of the Display is turned off, this operation is not available.

5 Operation buttons on the menu screen

Operates on the menu screen.

6 Image quality adjustments

Operate items related to image quality.

7 Back

Returns to the previous page.

Tools page

Click Tools on the operation page.

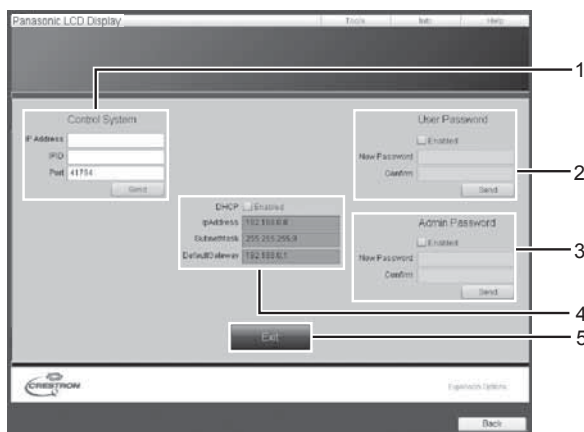

1 Control system

Sets the information required for the communication with the controller that is connected to the Display.

2 User Password

Sets the password for the user rights in the operation page of Crestron Connected™.

3 Admin Password

Sets the password for the administrator rights in the operation page of Crestron Connected™.

4 Network status

Displays the setting of LAN.

DHCP: Displays the value in the current setting.

IpAddress: Displays the value in the current setting.

SubnetMask: Displays the value in the current setting.

DefaultGateway: Displays the value in the current setting.

5 Exit

Return to the operation page.

Note:

When you monitor or control the Display using Crestron Connected™, set "Crestron Connected™" to "On" in the "Network Setup" menu. (see page 41)

Info page

Click Info on the operation page.

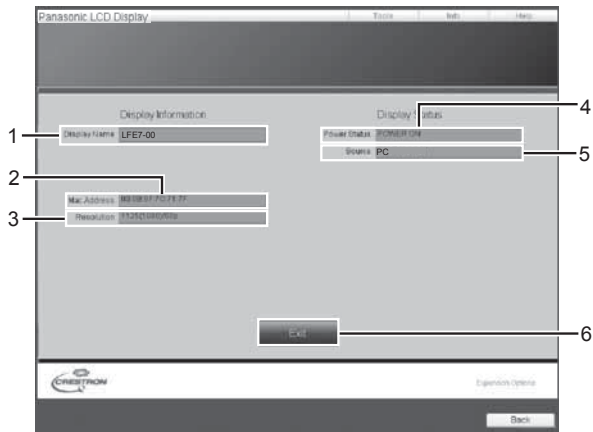

1 Display name

Displays the name of the Display.

2 Mac Address

Displays the MAC address.

3 Resolution

Displays the resolution of the Display.

4 Power Status

Displays the status of the power.

5 Source

Displays the selected video input.

6 Exit

Return the operation page.

Help page

Click Help on the operation page.

The Help Desk screen is displayed.

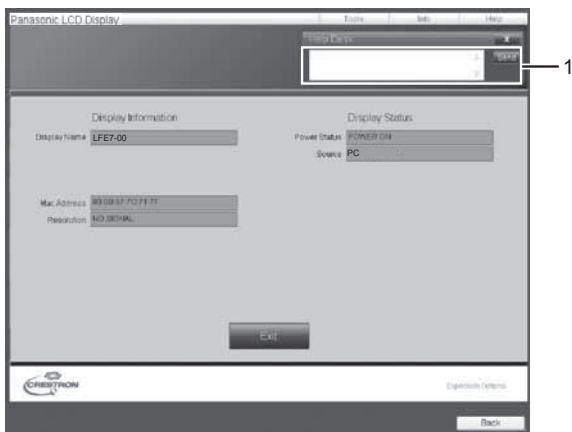









1 Help Desk

Sends or receive messages to the administrator who uses Crestron Connected™.

Troubleshooting

Before you call for service, determine the symptoms and make a few simple checks as shown below.

Symptoms		Checks
Picture	Sound	
 Interference	 Noisy Sound	Electrical Appliances Cars / Motorcycles Fluorescent light
 Normal Picture	 No Sound	Volume (Check whether the mute function has been activated on the remote control.)
 No Picture	 No Sound	Not plugged into AC outlet Not switched on PICTURE and BRIGHTNESS/Volume setting (Check by pressing the power switch or stand-by button on the remote control.)
 No Picture	 Normal Sound	If a signal with a non-applicable format, or frequency is input, only the input terminal indication is displayed.
No remote control operations can be performed.		Check whether the batteries have discharged completely and, if they have not, whether they were inserted properly. Check whether the remote control sensor is exposed to an outdoor light or a strong fluorescent light. Check whether the remote control designed specifically for use with the unit is being used. (The unit cannot be operated by any other remote control.)
A cracking sound is sometimes heard from the unit.		If there is nothing wrong with the picture or sound, this is the sound of the cabinet undergoing very slight contractions in response to changes in the room temperature. There are no adverse effects on the performance or other aspects.
The top or bottom of the picture on the screen is cut off when I use the zoom function.		Adjust the position of the picture on the screen.
Areas at the top and bottom of the screen where the image is missing appear when I use the zoom function.		When using a video software program (such as a cinema size program) with a screen wider than one in the 16:9 mode, blank areas separate from the images are formed at the top and bottom of the screen.
I can hear sounds coming from inside the unit.		When the power is turned on, a sound of the display panel being driven may be heard: This is normal and not indicative of malfunctioning.
Parts of the unit become hot.		Even when the temperature of parts of the front, top and rear panels has risen, these temperature rises will not pose any problems in terms of performance or quality.
Power automatically turns off unexpectedly.		Check the settings of "No Signal power off", "PC Power management", "DVI-D Power management" and "No activity power off". Any of them may be set to "On (Enable)". (see page 31, 32)
There is no picture displayed or sound output sometimes.		When HDMI or DVI signals are input to the Display using a selector or distributor, sound or images may not be output in the normal fashion depending on the selector or distributor used. The symptoms may be improved by turning the power off and on again, or by replacing the selector or distributor.
The RS-232C is uncontrollable		Check whether the connection has been made properly. (see page 12) When controlling the RS-232C command on page 12 from the RS-232C terminal in the display, make sure that "Control I/F Select" is "RS-232C". (see page 41)
The LAN is uncontrollable		Check whether the connection has been made properly. (see page 47) Check whether "Control I/F Select" is "LAN" when controlling with the WEB browser control or the command control on page 48. (see page 41) Check whether "LAN Setup" has been configured properly. (see page 42) When connecting to a device of AMX, Crestron Electronics, Inc., set "AMX D.D.", "Crestron Connected™", according to the device to use. (see page 41)
This LCD Display uses special image processing. Hence a slight time lag may occur between image and audio, depending on the type of input signal. However, this is not a malfunction.		

LCD Display panel

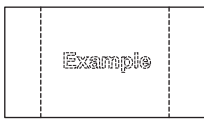
Symptoms	Check
The screen darkens slightly when bright pictures with minimal movements are shown.	The screen will darken slightly when photos, still images of a computer or other pictures with minimal movements are shown for an extended period. This is done to reduce image retention on the screen and the shortening of the screen's service life: It is normal and not indicative of malfunctioning.
It takes a while for the picture to appear.	The unit digitally processes the various signals in order to reproduce esthetically pleasing images. As such, it sometimes takes a few moments for the picture to appear when the power has been turned on, when the input has been switched.
The edges of the images flicker.	Due to the characteristics of the system used to drive the panel, the edges may appear to flicker in the fast-moving parts of the images: This is normal and not indicative of malfunctioning.
There may be red spots, blue spots, green spots and black spots on the screen.	This is a characteristic of liquid crystal panels and is not a problem. The liquid crystal panel is built with very high precision technology giving you fine picture details. Occasionally, a few non-active pixels may appear on the screen as fixed points of red, blue, green, or black. Please note this does not affect the performance of your LCD.
 <p>Image retention appears</p>	Image retention may occur. If you display a still picture for an extended period, the image might remain on the screen. However, it will disappear after a while. This is not considered as malfunction.

Applicable input signals

PC signals

*Mark: Applicable input signal

	Signal name	Horizontal frequency (kHz)	Vertical frequency (Hz)	PC IN (Dot clock (MHz))	DVI-D IN (Dot clock (MHz))	HDMI
1	640x400@70Hz	31.46	70.07	* (25.17)		
2	640x480@60Hz	31.47	59.94	* (25.18)	* (25.18)	*
3	640x480@72Hz	37.86	72.81	* (31.5)		
4	640x480@75Hz	37.50	75.00	* (31.5)		
5	640x480@85Hz	43.27	85.01	* (36.0)		
6	800x600@56Hz	35.16	56.25	* (36.0)		
7	800x600@60Hz	37.88	60.32	* (40.0)	* (40.0)	*
8	800x600@72Hz	48.08	72.19	* (50.0)		
9	800x600@75Hz	46.88	75.00	* (49.5)		
10	800x600@85Hz	53.67	85.06	* (56.25)		
11	852x480@60Hz	31.47	59.94		* (34.24)	*
12	1024x768@50Hz	39.55	50.00		* (51.89)	*
13	1024x768@60Hz	48.36	60.00	* (65.0)	* (65.0)	*
14	1024x768@70Hz	56.48	70.07	* (75.0)		
15	1024x768@75Hz	60.02	75.03	* (78.75)		
16	1024x768@85Hz	68.68	85.00	* (94.5)		
17	1066x600@60Hz	37.64	59.94		* (53.0)	*
18	1152x864@60Hz	53.70	60.00		* (81.62)	*
19	1152x864@75Hz	67.50	75.00	* (108.0)		
20	1280x768@60Hz	47.70	60.00	* (80.14)		
21	1280x960@60Hz	60.00	60.00	* (108.0)		
22	1280x960@85Hz	85.94	85.00	* (148.5)		
23	1280x1024@60Hz	63.98	60.02	* (108.0)	* (108.0)	*
24	1280x1024@75Hz	79.98	75.02	* (135.0)		
25	1280x1024@85Hz	91.15	85.02	* (157.5) *1		
26	1366x768@50Hz	39.55	50.00		* (69.92)	*
27	1366x768@60Hz	48.36	60.00	* (86.71)	* (87.44)	*
28	1400x1050@60Hz	65.22	60.00		* (122.61)	*
29	1600x1200@60Hz	75.00	60.00	* (162.0)	* (162.0)	*
30	1920x1080@60Hz	67.50	60.00	* (148.5)	* (148.5)	*
31	1920x1200@60Hz	74.04	59.95		* (154.0)	*
32	Macintosh13"(640x480)	35.00	66.67	* (30.24)		
33	Macintosh16"(832x624)	49.72	74.55	* (57.28)		
34	Macintosh21"(1152x870)	68.68	75.06	* (100.0)		

*1 Not compatible with SYNC ON G.

• The signal format automatically detected may differ from the actual input signal in display.

Component signals

*Mark: Applicable input signal

	Signal name	Horizontal frequency (kHz)	Vertical frequency (Hz)	DVI-D IN (Dot clock (MHz))	HDMI
1	525(480)/60i	15.73	59.94	* (27.0)	*
2	525(480)/60p	31.47	59.94	* (27.0)	*
3	625(575)/50i	15.63	50.00		
4	625(576)/50i	15.63	50.00	* (27.0)	*
5	625(575)/50p	31.25	50.00		*
6	625(576)/50p	31.25	50.00	* (27.0)	*
7	750(720)/60p	45.00	60.00	* (74.25)	*
8	750(720)/50p	37.50	50.00	* (74.25)	*
9	1,125(1,080)/60p	67.50	60.00	* (148.5)	*
10	1,125(1,080)/60i	33.75	60.00	* (74.25)	*
11	1,125(1,080)/50p	56.25	50.00	* (148.5)	*
12	1,125(1,080)/50i	28.13	50.00	* (74.25)	*
13	1,125(1,080)/24psF	27.00	48.00		
14	1,125(1,080)/30p	33.75	30.00	* (74.25)	*
15	1,125(1,080)/25p	28.13	25.00	* (74.25)	*
16	1,125(1,080)/24p	27.00	24.00	* (74.25)	*



Shipping condition

This function allows you to reset the unit to the factory setting.

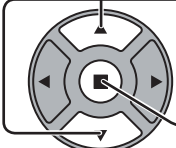
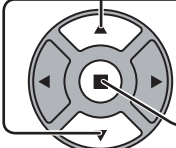
1  Press to display the Setup menu.

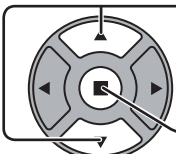
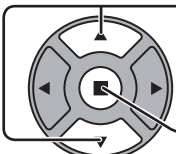
2  Press to select "OSD Language".
 Press for more than 3 seconds.

3  Press to select "Shipping".
 Press to display the Shipping menu.

4  Press to select "Yes".
 Press to confirm.

5 Wait for 10 seconds.

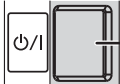
6  Press the power switch (⏻/|) on main unit to turn the power off.
* For TH-42LFE7U, TH-50LFE7U, TH-65LFE7U

If the power switch is locked, please disconnect the AC cord plug from the wall outlet.

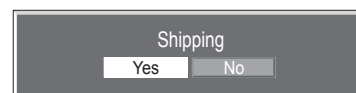
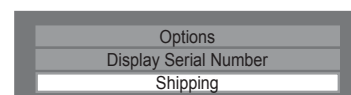
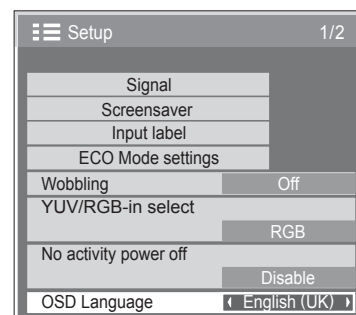

[from the unit]

- 1 Press the MENU button till the Setup menu is displayed.
- 2 Press the Volume Up "+" or Down "-" button to select "OSD Language".
- 3 Press and hold the ENTER button till the Shipping menu is displayed.
- 4 Press the Volume Up "+" or Down "-" button to select "Yes".
- 5 Press the ENTER button and wait for 10 sec.
- 6 Press the power switch (⏻/|) on main unit to turn the power off.
* For TH-42LFE7U, TH-50LFE7U, TH-65LFE7U
If the power switch is locked, please disconnect the AC cord plug from the wall outlet.

Specifications

	TH-42LFE7U	TH-42LFE7E/ER
Power Source	110 - 127 V AC, 50/60 Hz	220-240 V AC, 50/60 Hz
Power Consumption		
Rated Power Consumption		95 W
Stand-by condition		0.5 W
Power off condition		0.4 W
Sound		
Speakers		25 mm × 90 mm × 2 pcs
Audio Output		20 W [10 W+10 W] (10 % THD)
LCD Display panel	42-inch IPS panel (LED backlight), 16:9 aspect ratio	
Screen size	36.5" (W) × 20.5" (H) × 41.9" (diagonal) / 928 mm (W) × 522 mm (H) × 1,065mm (diagonal)	
(No.of pixels)	2,073,600 (1,920 (W) × 1,080 (H)) [5,760 × 1,080 dots]	
Operating condition		
Temperature	32 °F - 104 °F (0 °C - 40 °C)	
Humidity	20 % - 80 %	
Applicable signals		
Scanning format	525 (480) / 60i · 60p, 625 (575) / 50i · 50p, 750 (720) / 60p · 50p, 1125 (1080) / 60i · 60p · 50i · 50p · 24p · 25p · 30p · 24psF	
PC signals	VGA, SVGA, XGA, SXGA UXGA ···· (compressed) Horizontal scanning frequency 30 - 110 kHz Vertical scanning frequency 48 - 120 Hz	
Connection terminals		
AV IN	HDMI1 HDMI2	TYPE A Connector × 2
DVI-D IN	AUDIO	DVI-D 24 Pin Content Protection Stereo mini jack (M3) × 1 Compliance with DVI Revision 1.0 Compatible with HDCP 1.1 0.5 Vrms, Shared with PC IN
PC IN	AUDIO	High-Density Mini D-sub 15 Pin Stereo mini jack (M3) × 1 G with sync 1.0 Vp-p (75 Ω) G without sync 0.7 Vp-p (75 Ω) B: 0.7 Vp-p (75 Ω) R: 0.7 Vp-p (75 Ω) HD/VD: 1.0 - 5.0 Vp-p (high impedance) 0.5 Vrms, Shared with DVI-D IN
LAN		RJ45 10BASE-T/100BASE-TX, compatible with PLink™
SERIAL		External Control Terminal D-sub 9 Pin RS-232C compatible
AUDIO OUT		Stereo mini jack (M3) × 1 Output level: Variable (-∞ — 0 dB) 0.5 Vrms [INPUT 1 kHz / 0 dB, 10 kΩ Load]
CHARGE		5 V/500 mA
Dimensions (W × H × D)	38.0" × 22.3" × 3.1" / 963 mm × 566 mm × 77 mm	
Mass (weight)	approx. 20.94 lbs (9.5 kg)	

Notes:

- Design and specifications are subject to change without notice. Mass and dimensions shown are approximate.
- This equipment complies with the EMC standards listed below. EN55022, EN55024, EN61000-3-2, EN61000-3-3.

Specifications

	TH-50LFE7U	TH-50LFE7E
Power Source	110 - 127 V AC, 50/60 Hz	220-240 V AC, 50/60 Hz
Power Consumption		
Rated Power Consumption		95 W
Stand-by condition		0.5 W
Power off condition		0.4 W
Sound		
Speakers		25 mm × 90 mm × 2 pcs
Audio Output		20 W [10 W+10 W] (10 % THD)
LCD Display panel	50-inch VA panel (LED backlight), 16:9 aspect ratio	
Screen size	43.1" (W) × 24.3" (H) × 49.5" (diagonal) / 1,096 mm (W) × 616 mm (H) × 1,257mm (diagonal)	
(No. of pixels)	2,073,600 (1,920 (W) × 1,080 (H)) [5,760 × 1,080 dots]	
Operating condition		
Temperature	32 °F - 104 °F (0 °C - 40 °C)	
Humidity	20 % - 80 %	
Applicable signals		
Scanning format	525 (480) / 60i · 60p, 625 (575) / 50i · 50p, 750 (720) / 60p · 50p, 1125 (1080) / 60i · 60p · 50i · 50p · 24p · 25p · 30p · 24psF	
PC signals	VGA, SVGA, XGA, SXGA UXGA ··· (compressed) Horizontal scanning frequency 30 - 110 kHz Vertical scanning frequency 48 - 120 Hz	
Connection terminals		
AV IN	HDMI1 HDMI2	TYPE A Connector × 2
DVI-D IN	AUDIO	DVI-D 24 Pin Content Protection Stereo mini jack (M3) × 1 Compliance with DVI Revision 1.0 Compatible with HDCP 1.1 0.5 Vrms, Shared with PC IN
PC IN	AUDIO	High-Density Mini D-sub 15 Pin Stereo mini jack (M3) × 1 G with sync 1.0 Vp-p (75 Ω) G without sync 0.7 Vp-p (75 Ω) B: 0.7 Vp-p (75 Ω) R: 0.7 Vp-p (75 Ω) HD/VD: 1.0 - 5.0 Vp-p (high impedance) 0.5 Vrms, Shared with DVI-D IN
LAN		RJ45 10BASE-T/100BASE-TX, compatible with PLink™
SERIAL		External Control Terminal D-sub 9 Pin RS-232C compatible
AUDIO OUT		Stereo mini jack (M3) × 1 Output level: Variable (-∞ — 0 dB) 0.5 Vrms [INPUT 1 kHz / 0 dB, 10 kΩ Load]
CHARGE		5 V/500 mA
Dimensions (W × H × D)	44.4" × 25.7" × 2.1" / 1,126 mm × 652 mm × 53 mm	
Mass (weight)	approx. 31.97 lbs (14.5 kg)	

Notes:

- Design and specifications are subject to change without notice. Mass and dimensions shown are approximate.
- This equipment complies with the EMC standards listed below. EN55022, EN55024, EN61000-3-2, EN61000-3-3.

Specifications

	TH-65LFE7U	TH-65LFE7E
Power Source	110 - 127 V AC, 50/60 Hz	220-240 V AC, 50/60 Hz
Power Consumption		
Rated Power Consumption		135 W
Stand-by condition		0.5 W
Power off condition		0.4 W
Sound		
Speakers		22 mm × 90 mm × 2 pcs
Audio Output		20 W [10 W+10 W] (10 % THD)
LCD Display panel	65-inch VA panel (LED backlight), 16:9 aspect ratio	
Screen size	56.2" (W) × 31.6" (H) × 64.5" (diagonal) / 1,428 mm (W) × 803 mm (H) × 1,638mm (diagonal)	
(No.of pixels)	2,073,600 (1,920 (W) × 1,080 (H)) [5,760 × 1,080 dots]	
Operating condition		
Temperature	32 °F - 104 °F (0 °C - 40 °C)	
Humidity	20 % - 80 %	
Applicable signals		
Scanning format	525 (480) / 60i · 60p, 625 (575) / 50i · 50p, 750 (720) / 60p · 50p, 1125 (1080) / 60i · 60p · 50i · 50p · 24p · 25p · 30p · 24psF	
PC signals	VGA, SVGA, XGA, SXGA UXGA ··· (compressed) Horizontal scanning frequency 30 - 110 kHz Vertical scanning frequency 48 - 120 Hz	
Connection terminals		
AV IN	HDMI1 HDMI2	TYPE A Connector × 2
DVI-D IN	AUDIO	DVI-D 24 Pin Content Protection Stereo mini jack (M3) × 1 Compliance with DVI Revision 1.0 Compatible with HDCP 1.1 0.5 Vrms, Shared with PC IN
PC IN	AUDIO	High-Density Mini D-sub 15 Pin Stereo mini jack (M3) × 1 G with sync 1.0 Vp-p (75 Ω) G without sync 0.7 Vp-p (75 Ω) B: 0.7 Vp-p (75 Ω) R: 0.7 Vp-p (75 Ω) HD/VD: 1.0 - 5.0 Vp-p (high impedance) 0.5 Vrms, Shared with DVI-D IN
LAN		RJ45 10BASE-T/100BASE-TX, compatible with PLink™
SERIAL		External Control Terminal D-sub 9 Pin RS-232C compatible
AUDIO OUT		Stereo mini jack (M3) × 1 Output level: Variable (-∞ — 0 dB) 0.5 Vrms [INPUT 1 kHz / 0 dB, 10 kΩ Load]
CHARGE		5 V/500 mA
Dimensions (W × H × D)	57.4" × 33.1" × 2.1" / 1,458 mm × 840 mm × 52 mm	
Mass (weight)	approx. 73.85 lbs (33.5 kg)	

Notes:

- Design and specifications are subject to change without notice. Mass and dimensions shown are approximate.
- This equipment complies with the EMC standards listed below. EN55022, EN55024, EN61000-3-2, EN61000-3-3.

<Software Information for This Product>

This product has software installed partially licensed under the Free BSD LICENSE.

Free BSD LICENSE regulations under the above specifications are as follows:

(These regulations are set by the third party; therefore the original (English) regulations are stated.)

Copyright © 1980, 1986, 1993

The Regents of the University of California. All rights reserved.

Redistribution and use in source and binary forms, with or without modification, are permitted provided that the following conditions are met:

1. Redistributions of source code must retain the above copyright notice, this list of conditions and the following disclaimer.
2. Redistributions in binary form must reproduce the above copyright notice, this list of conditions and the following disclaimer in the documentation and/or other materials provided with the distribution.
3. All advertising materials mentioning features or use of this software must display the following acknowledgement: This product includes software developed by the University of California, Berkeley and its contributors.
4. Neither the name of the University nor the names of its contributors may be used to endorse or promote products derived from this software without specific prior written permission.

THIS SOFTWARE IS PROVIDED BY THE REGENTS AND CONTRIBUTORS "AS IS" AND ANY EXPRESS OR IMPLIED WARRANTIES, INCLUDING, BUT NOT LIMITED TO, THE IMPLIED WARRANTIES OF MERCHANTABILITY AND FITNESS FOR A PARTICULAR PURPOSE ARE DISCLAIMED. IN NO EVENT SHALL THE REGENTS OR CONTRIBUTORS BE LIABLE FOR ANY DIRECT, INDIRECT, INCIDENTAL, SPECIAL, EXEMPLARY, OR CONSEQUENTIAL DAMAGES (INCLUDING, BUT NOT LIMITED TO, PROCUREMENT OF SUBSTITUTE GOODS OR SERVICES; LOSS OF USE, DATA, OR PROFITS; OR BUSINESS INTERRUPTION) HOWEVER CAUSED AND ON ANY THEORY OF LIABILITY, WHETHER IN CONTRACT, STRICT LIABILITY, OR TORT (INCLUDING NEGLIGENCE OR OTHERWISE) ARISING IN ANY WAY OUT OF THE USE OF THIS SOFTWARE, EVEN IF ADVISED OF THE POSSIBILITY OF SUCH DAMAGE.

Information for Users on Collection and Disposal of Old Equipment and used Batteries



These symbols on the products, packaging, and/or accompanying documents mean that used electrical and electronic products and batteries should not be mixed with general household waste. For proper treatment, recovery and recycling of old products and used batteries, please take them to applicable collection points, in accordance with your national legislation and the Directives 2002/96/EC and 2006/66/EC.

By disposing of these products and batteries correctly, you will help to save valuable resources and prevent any potential negative effects on human health and the environment which could otherwise arise from inappropriate waste handling.

For more information about collection and recycling of old products and batteries, please contact your local municipality, your waste disposal service or the point of sale where you purchased the items. Penalties may be applicable for incorrect disposal of this waste, in accordance with national legislation.

For business users in the European Union

If you wish to discard electrical and electronic equipment, please contact your dealer or supplier for further information.

[Information on Disposal in other Countries outside the European Union]

These symbols are only valid in the European Union. If you wish to discard these items, please contact your local authorities or dealer and ask for the correct method of disposal.

Note for the battery symbol (bottom two symbol examples):

This symbol might be used in combination with a chemical symbol. In this case it complies with the requirement set by the Directive for the chemical involved.



Cd

USA only: Disposal may be regulated in your community due to environmental considerations. For disposal or recycling information, please visit Panasonic website: <http://www.panasonic.com/environmental> or call 1-888-769-0149.

Customer's Record

The model number and serial number of this product can be found on its rear panel. You should note this serial number in the space provided below and retain this book, plus your purchase receipt, as a permanent record of your purchase to aid in identification in the event of theft or loss, and for Warranty Service purposes.

Model Number _____

Serial Number _____

For TH-42LFE7U, TH-50LFE7U, TH-65LFE7U

Panasonic System Communications Company of North America

Unit of Panasonic Corporation of North America

Executive Office :

Two Riverfront Plaza, Newark, New Jersey 07102-5490

Panasonic Canada Inc.

5770 Ambler Drive
Mississauga, Ontario
L4W 2T3

Panasonic Corporation

Web Site : <http://panasonic.net>

© Panasonic Corporation 2014