

## Operating Instructions

LCD Video Monitor

Model No. **BT-LH2170P**

Model No. **BT-LH2170E**

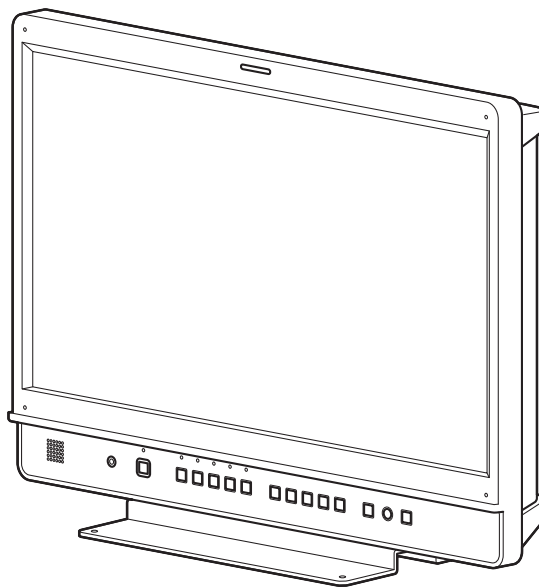

**DEUTSCH**

Für Erläuterungen in Deutsch, konsultieren Sie bitte die mitgelieferte CD-ROM.  
(Zurück Decke)

**FRANÇAIS**

Pour des explications en français, veuillez vous reporter au CD-ROM fourni.  
(Quatrième de couverture)

**ITALIANO**

Per le istruzioni in italiano, vedere il CD-ROM in dotazione. (Retro della copertina)

**ESPAÑOL**

Para la explicación en español, consulte el CD-ROM suministrado. (Cubierta trasera)

This manual is also contained as a PDF file on the CD-ROM supplied with the unit. (Back cover)

**HDMI™**  
HIGH-DEFINITION MULTIMEDIA INTERFACE

Before operating this product, please read the instructions carefully and save this manual for future use.

# Read this first ! (for BT-LH2170P)



**CAUTION:** TO REDUCE THE RISK OF ELECTRIC SHOCK, DO NOT REMOVE COVER (OR BACK). NO USER-SERVICEABLE PARTS INSIDE. REFER SERVICING TO QUALIFIED SERVICE PERSONNEL.



The lightning flash with arrowhead symbol, within an equilateral triangle, is intended to alert the user to the presence of uninsulated "dangerous voltage" within the product's enclosure that may be of sufficient magnitude to constitute a risk of electric shock to persons.



The exclamation point within an equilateral triangle is intended to alert the user to the presence of important operating and maintenance (servicing) instructions in the literature accompanying the appliance.

## **WARNING:**

This equipment must be grounded. To ensure safe operation, the three-pin plug must be inserted only into a standard three-pin power outlet which is effectively grounded through normal household wiring. Extension cords used with the equipment must have three cores and be correctly wired to provide connection to the ground. Wrongly wired extension cords are a major cause of fatalities. The fact that the equipment operates satisfactorily does not imply that the power outlet is grounded or that the installation is completely safe. For your safety, if you are in any doubt about the effective grounding of the power outlet, please consult a qualified electrician.

## **WARNING:**

- To reduce the risk of fire or electric shock, do not expose this equipment to rain or moisture.
- To reduce the risk of fire or electric shock hazard, keep this equipment away from all liquids. Use and store only in locations which are not exposed to the risk of dripping or splashing liquids, and do not place any liquid containers on top of the equipment.

## **WARNING:**

Always keep the stand screws and protective panel mounting screws out of the reach of infants and small children.

## **WARNING:**

Installation should only be performed by qualified installation personnel. Improper installation may result in the entire apparatus falling down and causing injury.

## **CAUTION:**

The mains plug of the power supply cord shall remain readily operable. The AC receptacle (mains socket outlet) shall be installed near the equipment and shall be easily accessible. To completely disconnect this equipment from the AC mains, disconnect the power cable plug from the AC receptacle.

## **CAUTION:**

In order to maintain adequate ventilation, do not install or place this unit in a bookcase, built-in cabinet or any other confined space. To prevent risk of electric shock or fire hazard due to overheating, ensure that curtains and any other materials do not obstruct the ventilation.

## **CAUTION:**

To reduce the risk of fire or electric shock and annoying interference, use the recommended accessories only.

## **CAUTION:**

This apparatus can be operated at a voltage in the range of 100 - 240 V AC. Voltages other than 120 V are not intended for U.S.A. and Canada.

## **CAUTION:**

Excessive sound pressure from earphones and headphones can cause hearing loss.

## **CAUTION:**

This Monitor is for use only with Panasonic Wall Mount Adaptor, BT-WMA17G. Use with other Wall Mount or Rack Mount Adaptor is capable of resulting in instability causing possible injury.

## **CAUTION:**

Check the installation at least once a year. An improper installation could cause the monitor to fall off resulting in personal injury.

## **CAUTION:**

Remove the wall mount adaptor when not used. Otherwise people moving in the vicinity of the monitor could get caught on the bracket and be injured.

 indicates safety information.

## **Notice (U.S.A. only):**

Disposal may be regulated in your community due to Environmental considerations. For disposal or recycling information, please visit Panasonic website: <http://www.panasonic.com/environmental> or call 1-888-769-0149.

### FCC NOTICE (USA)

This device complies with part 15 of the FCC Rules. Operation is subject to the following two conditions:

(1) This device may not cause harmful interference, and (2) this device must accept any interference received, including interference that may cause undesired operation

#### CAUTION:

This equipment has been tested and found to comply with the limits for a class A digital device, pursuant to Part 15 of the FCC Rules. These limits are designed to provide reasonable protection against harmful interference when the equipment is operated in a commercial environment. This equipment generates, uses, and can radiate radio frequency energy and, if not installed and used in accordance with the instruction manual, may cause harmful interference to radio communications.

Operation of this equipment in a residential area is likely to cause harmful interference in which case the user will be required to correct the interference at his own expense.

#### Warning:

To assure continued FCC emission limit compliance, the user must use only shielded interface cables when connecting to external units. Also, any unauthorized changes or modifications to this equipment could void the user's authority to operate it.

 indicates safety information.

## IMPORTANT SAFETY INSTRUCTIONS

- 1) Read these instructions.
- 2) Keep these instructions.
- 3) Heed all warnings.
- 4) Follow all instructions.
- 5) Do not use this apparatus near water.
- 6) Clean only with dry cloth.
- 7) Do not block any ventilation openings. Install in accordance with the manufacturer's instructions.
- 8) Do not install near any heat sources such as radiators, heat registers, stoves, or other apparatus (including amplifiers) that produce heat.
- 9) Do not defeat the safety purpose of the polarized or grounding-type plug. A polarized plug has two blades with one wider than the other. A grounding-type plug has two blades and a third grounding prong. The wide blade or the third prong are provided for your safety. If the provided plug does not fit into your outlet, consult an electrician for replacement of the obsolete outlet.
- 10) Protect the power cable from being walked on or pinched particularly at plugs, convenience receptacles, and the point where they exit from the apparatus.
- 11) Only use attachments/accessories specified by the manufacturer.
- 12) Use only with the cart, stand, tripod, bracket, or table specified by the manufacturer, or sold with the apparatus. When a cart is used, use caution when moving the cart/apparatus combination to avoid injury from tip-over.
- 13) Unplug this apparatus during lightning storms or when unused for long periods of time.
- 14) Refer all servicing to qualified service personnel. Servicing is required when the apparatus has been damaged in any way, such as power-supply cord or plug is damaged, liquid has been spilled or objects have fallen into the apparatus, the apparatus has been exposed to rain or moisture, does not operate normally, or has been dropped.



# Read this first ! (for BT-LH2170E)

## WARNING:

This equipment must be earthed.  
To ensure safe operation, the three-pin plug must be inserted only into a standard three-pin power point which is effectively earthed through normal household wiring. Extension cords used with the equipment must have three cores and be correctly wired to provide connection to the earth. Wrongly wired extension cords are a major cause of fatalities. The fact that the equipment operates satisfactorily does not imply that the power point is earthed or that the installation is completely safe. For your safety, if you are in any doubt about the effective earthing of the power point, please consult a qualified electrician.

## WARNING:

- To reduce the risk of fire or electric shock, do not expose this equipment to rain or moisture.
- To reduce the risk of fire or electric shock hazard, keep this equipment away from all liquids. Use and store only in locations which are not exposed to the risk of dripping or splashing liquids, and do not place any liquid containers on top of the equipment.

## WARNING:

Always keep the stand screws and protective panel mounting screws out of the reach of infants and small children.

## WARNING:

Installation should only be performed by qualified installation personnel.  
Improper installation may result in the entire apparatus falling down and causing injury.

## CAUTION:

Do not remove panel covers by unscrewing them.  
To reduce the risk of electric shock, do not remove covers.  
No user serviceable parts inside.  
Refer servicing to qualified service personnel.

## CAUTION:

The mains plug of the power supply cord shall remain readily operable.  
The AC receptacle (mains socket outlet) shall be installed near the equipment and shall be easily accessible. To completely disconnect this equipment from the AC mains, disconnect the power cable plug from the AC receptacle.

## CAUTION:

To reduce the risk of fire or electric shock and annoying interference, use the recommended accessories only.

## CAUTION:

In order to maintain adequate ventilation, do not install or place this unit in a bookcase, built-in cabinet or any other confined space. To prevent risk of electric shock or fire hazard due to overheating, ensure that curtains and any other materials do not obstruct the ventilation.

## CAUTION:

Excessive sound pressure from earphones and headphones can cause hearing loss.

## CAUTION:

This Monitor is for use only with Panasonic Wall Mount Adaptor, BT-WMA17G. Use with other Wall Mount or Rack Mount Adaptor is capable of resulting in instability causing possible injury.

## CAUTION:

Check the installation at least once a year.  
An improper installation could cause the monitor to fall off resulting in personal injury.

## CAUTION:

Remove the wall mount adaptor when not used.  
Otherwise people moving in the vicinity of the monitor could get caught on the bracket and be injured.

 indicates safety information.

**EEE Yönetmeliğine Uygundur.**  
**EEE Complies with Directive of Turkey.**

## [ India Only ]



For the purpose of recycling to facilitate effective utilization of resources, please return this product to a nearby authorized collection center, registered dismantler or recycler, or Panasonic service center when disposing of this product.

Please see the Panasonic website for further information on collection centers, etc.

<http://www.panasonic.co.in/wps/portal/home>

## Caution for AC Mains Lead

### FOR YOUR SAFETY PLEASE READ THE FOLLOWING TEXT CAREFULLY.

This product is equipped with 2 types of AC mains cable. One is for continental Europe, etc. and the other one is only for U.K.

Appropriate mains cable must be used in each local area, since the other type of mains cable is not suitable.

#### FOR CONTINENTAL EUROPE, ETC.

Not to be used in the U.K.

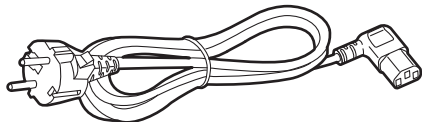

#### FOR U.K. ONLY

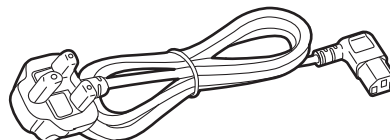

#### FOR U.K. ONLY

This appliance is supplied with a moulded three pin mains plug for your safety and convenience.

A 13 amp fuse is fitted in this plug.

Should the fuse need to be replaced please ensure that the replacement fuse has a rating of 13 amps and that it is approved by ASTA or BSI to BS1362.

Check for the ASTA mark  or the BSI mark  on the body of the fuse.

If the plug contains a removable fuse cover you must ensure that it is refitted when the fuse is replaced.

If you lose the fuse cover the plug must not be used until a replacement cover is obtained.

A replacement fuse cover can be purchased from your local Panasonic Dealer.

#### How to replace the fuse

1. Open the fuse compartment with a screwdriver.

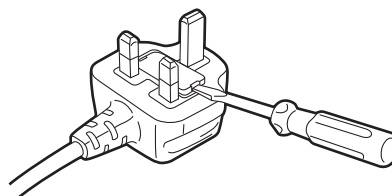

2. Replace the fuse.

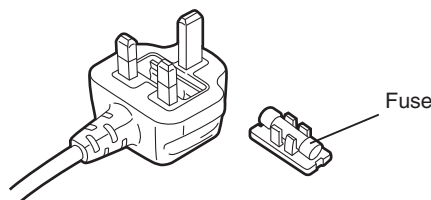

 indicates safety information.

### Note regarding the Power Management function specified under COMMISSION REGULATION (EC) No 1275/2008 implementing Directive 2009/125/EC of the European Parliament and of the Council.

This device is designed and manufactured for use at a broadcasting station and/or in a similar environment.

This device is not equipped with a Power Management function or the Power Management function is set to OFF as it will prevent the device from fulfilling its intended purpose for the reasons below.

1. If the device is a Studio Camera, a Weather Camera, a Mixer or other processor:

A Power Management function may cause the device to suddenly stop during recording or while On Air.

2. If the device is a Studio Monitor:

A Power Management function may cause video for the confirmation of whether a signal is normal, or whether the signal has been lost, to be un-viewable.

3. If the device is a Camera Recorder:

A professional camera recorder must be able to start quickly at any time, but a Power Management function will cause an increase in the time taken to resume from Stand-by mode.

Pursuant to at the directive 2004/108/EC, article 9(2)

Panasonic Testing Centre

Panasonic Marketing Europe GmbH

Winsbergring 15, 22525 Hamburg, Germany

## EMC NOTICE FOR THE PURCHASER/USER OF THE APPARATUS

### 1. Applicable standards and operating environment

The apparatus is compliant with:

- standards EN55103-1 and EN55103-2 2009, and
- electromagnetic environments E1, E2, E3 and E4.

### 2. Pre-requisite conditions to achieving compliance with the above standards

#### <1> Peripheral equipment to be connected to the apparatus and special connecting cables

- The purchaser/user is urged to use only equipment which has been recommended by us as peripheral equipment to be connected to the apparatus.
- The purchaser/user is urged to use only the connecting cables described below.

#### <2> For the connecting cables, use shielded cables which suit the intended purpose of the apparatus.

- Video signal connecting cables

Use double shielded coaxial cables, which are designed for 75-ohm type high-frequency applications, for SDI (Serial Digital Interface).

Coaxial cables, which are designed for 75-ohm type high-frequency applications, are recommended for analog video signals.

- Audio signal connecting cables

If your apparatus supports AES/EBU serial digital audio signals, use cables designed for AES/EBU.

Use shielded cables, which provide quality performance for high-frequency transmission applications, for analog audio signals.

- Other connecting cables (IEEE1394, USB)

Use shielded cables, which provide quality performance for high-frequency applications, as connecting cables.

- When connecting to the DVI signal terminal, use a cable with a ferrite core.
- If your apparatus is supplied with ferrite core(s), they must be attached on cable(s) following instructions in this manual.

### 3. Performance level

The performance level of the apparatus is equivalent to or better than the performance level required by these standards.

However, the apparatus may be adversely affected by interference if it is being used in an EMC environment, such as an area where strong electromagnetic fields are generated (by the presence of signal transmission towers, cellular phones, etc.).

In order to minimize the adverse effects of the interference on the apparatus in cases like this, it is recommended that the following steps be taken with the apparatus being affected and with its operating environment:

1. Place the apparatus at a distance from the source of the interference.
2. Change the direction of the apparatus.
3. Change the connection method used for the apparatus.
4. Connect the apparatus to another power outlet where the power is not shared by any other appliances.

### Декларація про Відповідність

Вимогам Технічного Регламенту Обмеження Використання деяких Небезпечних Речовин в електричному та електронному обладнанні  
(затвердженого Постановою №1057 Кабінету Міністрів України)

Виріб відповідає вимогам Технічного Регламенту Обмеження Використання деяких Небезпечних Речовин в електричному та електронному обладнанні (ТР ОБНР).

Вміст небезпечних речовин у випадках, не обумовлених в Додатку №2 ТР ОБНР, :

1. свинець(Pb) – не перевищує 0,1 % ваги речовини або в концентрації до 1000 частин на мільйон;
2. кадмій (Cd)– не перевищує 0,01 % ваги речовини або в концентрації до 100 частин на мільйон;
3. ртуть(Hg) – не перевищує 0,1 % ваги речовини або в концентрації до 1000 частин на мільйон;
4. шестивалентний хром (Cr6+ ) – не перевищує 0,1 % ваги речовини або в концентрації до 1000 частин на мільйон;
5. полібромбіфеноли (ПВБ) – не перевищує 0,1% ваги речовини або в концентрації до 1000 частин на мільйон;
6. полібромдефенілові ефіри (ПВДЕ) – не перевищує 0,1 % ваги речовини або в концентрації до 1000 частин на мільйон.

# Transportation precautions

---

Do not try to lift the monitor by grabbing the LCD panel.



Do not place the monitor face down during transportation to prevent damaging it. Keep it upright.

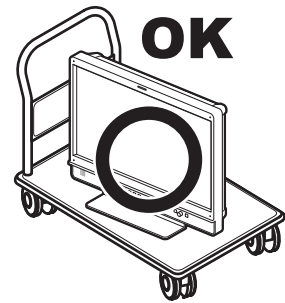

Do not expose the LCD panel to strong pressure or pressure from pointed objects. Take care especially during transportation. Exposing the LCD panel to strong pressure may result in blurring or other damage.

## About this instruction manual

---

- This instruction manual refers to BT-LH2170P/BT-LH2170E as “this unit.”
- The illustrations, explanatory drawings, and other figures included in this instruction manual are for illustrative purposes only and may differ from actual appearance.
- HDMI, the HDMI logo, and High-Definition Multimedia Interface are trademarks or registered trademarks of HDMI Licensing, LLC in the United States and/or other countries.
- Adobe® Reader® is a trademark of Adobe Systems Incorporated.
- Page references are indicated as (→ page 00) in this manual.

## Precautions for Use

---

- The LCD monitor is manufactured with high-precision technology and has an effective pixel count of over 99.99 %. However, less than 0.01 % of pixels may be stuck or dead. This is not a malfunction and does not affect recorded images.
- When a still image is displayed for an extended period of time, it may generate a temporary afterimage (phosphor burn-in). (However, such images can be removed by displaying normal video for a while.)
- LCD response speed and brightness vary with ambient temperatures.
- Do not install the unit where it is exposed to direct sunlight. It may damage the cabinet and LCD screen.
- Do not install the unit in locations where enough space cannot be provided around it as heat may build up inside preventing normal operation. Be sure to provide enough space around the unit.
- Exposing the LCD screen to intense light sources will impair its characteristics and lower image quality.
- In an environment exposed to drastic temperature fluctuations, condensation may build up on and inside the LCD screen. This may lower the quality of the screen and may damage it.
- Some video images may appear blurred on the screen.
- Leaving the unit in a location exposed to high temperature and humidity for an extended period of time may damage the LCD screen and cause blurring.
- Streaks of light may be seen in the area between the edge of the screen and the frame; this is normal and not a malfunction.
- The LCD panel is covered by the packaging material to protect it from damage during transportation and when unpacking it. Remove the packaging material before use.
- This unit does not support VIERA Link. When the unit is connected to a VIERA-Link-compatible device via an HDMI cable, VIERA Link functions on the other devices may not operate properly.
- Using the unit near a wireless transmitter, high-voltage equipment, speakers, large motors or other devices or exposing it to static electricity could cause electromagnetic interference and distort audio and video reception.



# Table of Contents

<b>Read this first ! (for BT-LH2170P)</b> .....	2	Loading user data.....	22
<b>Read this first ! (for BT-LH2170E)</b> .....	4	<b>Main Menu</b> .....	<b>23</b>
<b>Transportation precautions</b> .....	7	Menu configuration.....	23
<b>About this instruction manual</b> .....	7	2D/3D ASSIST.....	24
<b>Precautions for Use</b> .....	7	MARKER.....	24
<b>Standard accessories · Optional units</b> .....	9	MARKER types.....	26
<b>Outline</b> .....	9	VIDEO CONFIG.....	27
<b>Dimensions</b> .....	10	SYSTEM CONFIG.....	30
<b>Controls and Their Functions</b> .....	11	Performing AUTO CALIBRATION.....	33
Video monitor.....	11	RESET operation.....	33
Front panel.....	12	FUNCTION.....	34
Rear panel.....	13	GPI.....	43
<b>Power supply</b> .....	14	INPUT SELECT.....	44
Connecting the power cable.....	14	AUDIO.....	45
<b>Detaching and Attaching the Stand</b> .....	15	DISPLAY SETUP.....	46
Detaching the stand.....	15	CONTROL.....	48
Attaching the stand.....	15	HOURS METER.....	48
<b>On-screen Display</b> .....	16	<b>3D Assist Mode</b> .....	<b>49</b>
Operating status display.....	16	MIRROR (Left/Right and Top/Bottom inversion).....	50
Main menu (MAIN MENU)/FUNCTION menu/ INPUT SELECT menu displays.....	16	SHIFT (Horizontal and Vertical Shift).....	50
Picture adjusting (PICTURE) menu display.....	17	COMPARISON (Composition Check).....	51
Audio volume display.....	17	CONVERGENCE (Convergence Check).....	51
Sharpness display.....	17	COLOR (Color Check).....	52
FUNCTION display.....	17	ZOOM FOCUS (Zoom and Focus Check).....	52
Audio volume bar meter display.....	18	VERTICAL (Vertical Offset Check).....	53
Time code (TC) display.....	18	OVERLAY (Parallax Check).....	53
Closed caption (CC) display.....	19	<b>Setting Item Restrictions</b> .....	<b>55</b>
IMD (in monitor display) display.....	19	<b>REMOTE Specifications</b> .....	<b>60</b>
<b>How to Use the On Screen Menu</b> .....	20	GPI input terminal.....	60
Main menu (MAIN MENU).....	20	RS-232C input terminal.....	62
FUNCTION menu.....	20	RS-485 input/output terminal.....	63
INPUT SELECT menu.....	20	<b>Maintenance Inspections</b> .....	<b>70</b>
Picture adjusting (PICTURE) menu.....	21	<b>Error and Warning Information</b> .....	<b>71</b>
Audio volume.....	21	<b>Maintenance</b> .....	<b>71</b>
<b>User Data</b> .....	22	<b>Specifications</b> .....	<b>72</b>
Saving user data.....	22	<b>Index</b> .....	<b>78</b>



# Standard accessories · Optional units

---

## ■ Standard accessories

Power cable x 1 (BT-LH2170P)

Power cable x 2 (BT-LH2170E)

Stand (already attached to the product) x 1

Stand screws (already attached to the product) x 3

CD-ROM x 1

Protection panel mounting screws (8 mm long M3 screws) x 4

• The customer can use these screws for permanent attachment of a protective panel designed for the monitor. (→page 11)

• Tightening torque: Tighten to about 30 N·cm or less

### <Note>

After unpacking the monitor, dispose of the AC cord cap (BT-LH2170E only) and packaging material in an appropriate manner.

## ■ Optional units

• BT-WMA17G wall mount adapter (Leave installation of the wall mount adapter to authorized personnel.)

# Outline

---

The BT-LH2170P/BT-LH2170E is a compact, flat panel LCD monitor for broadcast and industrial applications, equipped with a 54.6 cm (21.5 inch) (effective display area) LCD display.

## ■ High performance LCD panel

This product incorporates a full HD (1920 x 1080) LCD panel. It offers excellent color reproduction, a wide viewing angle, and a fast response time.

## ■ Superb Moving Image Quality Achieved by New Image Processing Engine

- A 3D Look Up Table (LUT) and a 10-bit image processing engine facilitate accurate and smooth gradation from low to high brightness levels.
- The inclusion of an I/P conversion circuit with a low delay of less than one field minimizes the delay time between signal input and monitor display.
- The use of a diagonal line compensation circuit reduces image degradation in the vertical direction and jagged noise on diagonal lines.
- The high-speed moving image response time provides vivid and clear image display.
- Gamma compensation is performed for each monitor.

## ■ Includes 3D Assist Functions

Various assist functions are included to allow connecting the left and right connectors of a 3D camera to the two SDI inputs and capturing 3D images that are easier to view on a 2D monitor. These functions also make camera adjustments easier and reduce the preparation time required for 3D shooting.

## ■ Wide Variety of Functions and Interfaces

- Equipped with 3G-SDI, SDI (HD/SD compatible), HDMI, VIDEO, and DVI-I inputs.
- FOCUS-IN-RED function (Displayed abbreviated to F-IN-R in the [PICTURE] (picture adjusting) menu.)  
Focusing the camera is extremely easy because the area of the image in focus is displayed in red to make it easy to see what is in focus.

- WFM (Y/R/G/B) and vectorscope display functions  
Capable of showing a Y/R/G/B waveform display for input signals (3G-SDI, SDI, HDMI, VIDEO, and DVI-I inputs) and a vectorscope display (for 3G-SDI and SDI inputs).
- Audio volume bar meter display function  
There are level displays for embedded 3G-SDI, SDI and HDMI audio signals and analog audio signals. Furthermore, support is also included for reference point setting, peak hold, and overrange display.  
The incorporation of a speaker and a HEADPHONES output jack means you can check the audio. There is also a menu for selecting channels.
- Closed caption function  
The captions added to video signals can be displayed during SDI and VIDEO input.
- 2-screen display function  
The screen can be split into two to allow you to make a screen comparison for the same input connectors and same format. (SUB WINDOW function)  
It can display two SDI inputs simultaneously in two windows. (TWO WINDOW function)  
One input signal can be displayed on two windows for 3G-SDI, SDI, HDMI, VIDEO and DVI-I input VIDEO formats in combination with FOCUS-IN-RED, Y MAP, ZEBRA and other functions to simplify camera adjustments. (PICTURE ASSIST function)
- Cross hatch display function  
This function displays markers at regular vertical and horizontal intervals to facilitate easy composition.
- External remote control  
RS-485, RS-232C and GPI remote control terminals are provided.  
A loop-through connection using the RS-485 input and output terminals allows control of multiple monitors (up to 32 monitors).
- IMD (in-monitor display) display  
The RS-485 interface allows you to display text and the tally indication on the monitor.

# Dimensions

Unit: mm (inches)

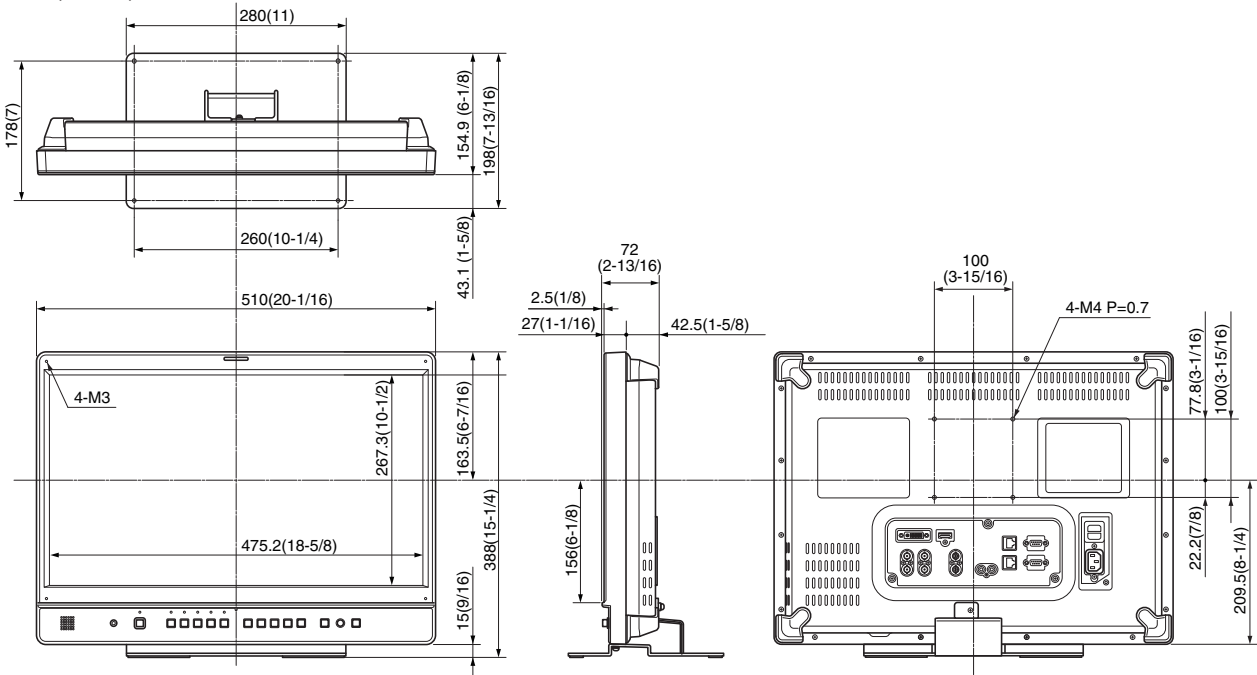

- When the unit will be permanently installed in one place, we recommend securing it in place using the screw holes at the bottom of the stand.

# Controls and Their Functions

## Video monitor

Front panel

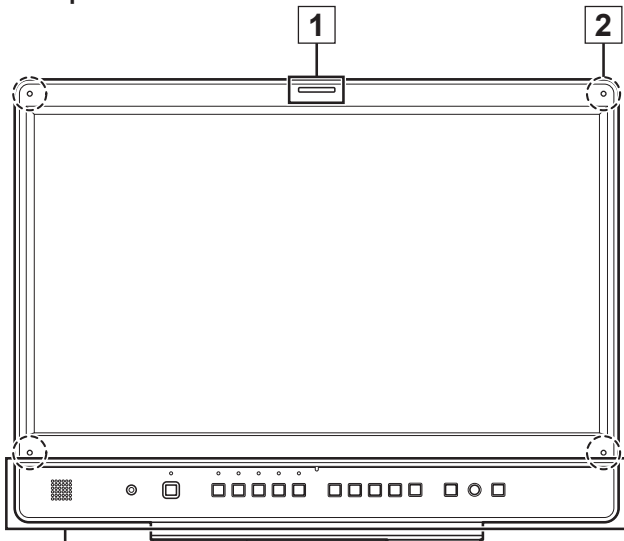

Front panel  
(→page 12)

Rear panel

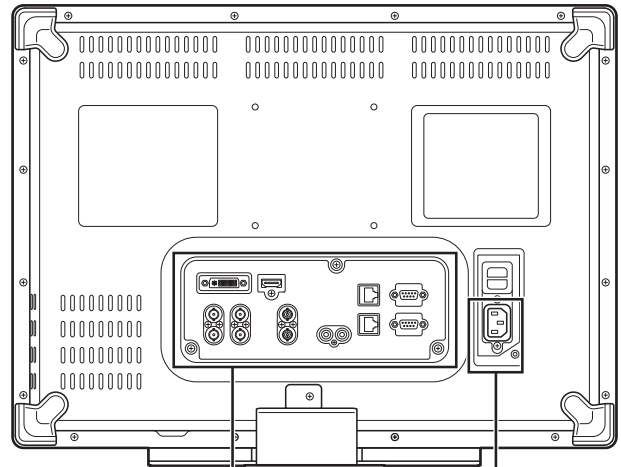

Rear panel  
(→page 13)

Power Supply  
(You can switch between AC  
and DC (→page 14))

### 1 Tally Lamp (Red and Green)

Can be lit by a control signal (red tally and green tally) via GPI.

When both the red and green tally are triggered together, the lamp lights amber.

### 2 Protective panel mounting screw holes (4 holes)

Four screw holes have been provided to enable attachment of a permanent protective panel.

#### <Note>

The LCD panel is shipped in packaging material to protect it from damage during unpacking and transportation. Remove the packaging material before using the monitor.

Front panel

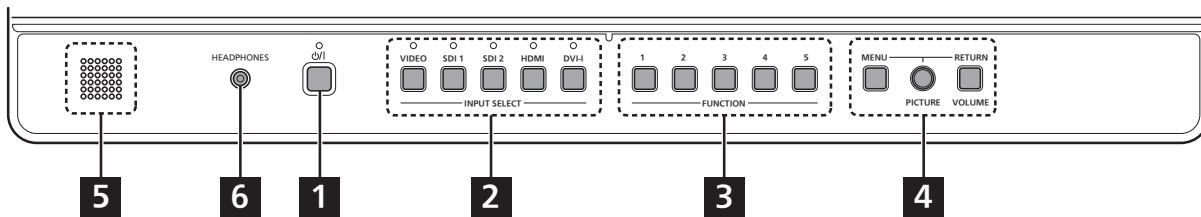

**1 POWER <⏻/▶> switch**

Switches the power supply ON/OFF. When the power is on, the LED (green) lights.  
To turn the power off, press and hold the switch for at least three seconds.

**2 INPUT SELECT buttons**

Selects the signal input line. The green LED light above the pressed button indicates the selected input signal.

VIDEO : Video input

SDI1 : Serial digital interface input (compatible with 3G/HD/SD)

SDI2 : Serial digital interface input (HD/SD compatible)

HDMI : HDMI input (HDCP compatible)

DVI-I : DVI-I input (HDCP compatible)

- Selects one of the following four input signals: digital video or PC signal, analog video or PC signal.(→page 44)

- When the power is turned on, the input line used when the power was last turned off is selected.
- In 3D assist and TWO WINDOW mode, the input is fixed to SDI1/SDI2 and the input line cannot be changed. (Then both the SDI1 and SDI2 LEDs go on.)
- Switching the [2D/3D ASSIST] menu from [3D ASSIST] to [2D] will return the input line to the previous 2D setting.
- Switching the TWO WINDOW function from ON to OFF will return the input line to the previous OFF setting. However, turning on the SUB WINDOW function or the PICTURE ASSIST function when the TWO WINDOW function is on, activates SDI1 operation, and when the 2-screen display function is off, the SDI1 input line is used.
- When the control lock is on, the  mark appears and input lines cannot be changed.(→page 48)
- When INT-SG (internal chart for adjustment [Color Bar + Grayscale]) is selected, all LEDs above the <INPUT SELECT> button are off. Use the [INPUT SELECT] menu to select INT-SG. (→page 20)

**3 FUNCTION button**

FUNCTION1 to FUNCTION5:

Press to use function assigned to the FUNCTION button using a menu.

- When the control lock is on, the  mark appears to indicate that FUNCTION operation is disabled.(→page 48)

**4 MENU button, rotary knob (with push-on switch (PICTURE) and RETURN/VOLUME button (→page 16)**

Use these buttons to display menus, select and adjust settings and perform menu selections.

MENU: Press to display or exit the [TOP MENU] ([MAIN MENU] (main menu), [FUNCTION] menu and [INPUT SELECT] menu).

Rotary knob: Turn the knob clockwise or counterclockwise to move the cursor up or down or to change set values.

Press the knob to start changing set values, to confirm them and to open submenus.

RETURN: Press to return to the previous menu or cancel to recover a previously set value.

When no menu is open, press the rotary knob <PICTURE> or <RETURN/VOLUME> button to open a menu other than the [TOP MENU].

PICTURE: When no menu is open, press the rotary knob to open the [PICTURE] (picture adjusting) menu.(→page 17)

VOLUME : When no menu is open, press the <RETURN/VOLUME> button to open the audio volume bar meter.(→page 17)

**5 Speaker (monaural)\*1**

Enables monitoring of analog AUDIO, SDI and HDMI signal inputs.

- Connecting headphones to the HEADPHONES output jack turns off the speaker.

**6 HEADPHONES output jack (M3 stereo mini jack)\*1**

Allows you to connect headphones to monitor analog audio, SDI and HDMI signal inputs.

- The sound volume and sound quality will depend on the headphones.

- \*1
- In 3D assist mode, you can monitor the left (L) channel of SDI1 audio.
  - In TWO WINDOW mode, you can monitor SDI1 and SDI2 audio selected using [AUDIO OUT SEL.].

Rear panel

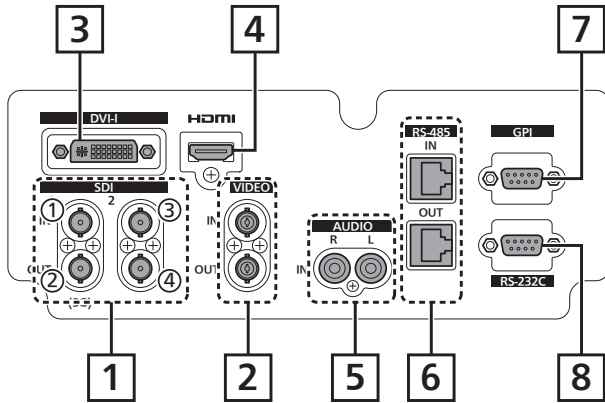

**1 SDI terminal**

- ① SDI1 (3G/HD/SD) input terminal (BNC)  
This is the SDI input terminal. (Compatible with 3G-SDI and 3G/HD/SD automatic switching)  
In 3D assist mode, input images for the left eye (L).
- ② SDI1 active through output terminal (BNC)  
This terminal outputs SDI1 input as is.
- ③ SDI2 (HD/SD) input terminal (BNC)  
This is the SDI input terminal. (Compatible with HD/SD automatic switching)  
In 3D assist mode, input images for the right eye (R).
- ④ SDI2 active through output terminal (BNC)  
This terminal outputs SDI2 input as is.

- When this output is used to daisy-chain\*1 multiple monitors, the quality of the original signal, cable length, the number of connected devices and other factors all come into play to deteriorate picture quality and introduce noise.

**\*1 Daisy-chain:**

Refers to connecting the through-out signal from a device to the input of a second, third or more devices in a linear series, thus using a single signal in multiple devices.

- Use a 5C-FB or equivalent cable to make connections to an SDI terminal.

**2 VIDEO terminal (BNC) \*2\*3**

IN : This is the VIDEO signal (composite signal) input terminal.

OUT : This is the input signal through-out terminal.

\*2 Unless a cable is connected to the VIDEO OUT terminal, the VIDEO IN terminal is automatically terminated at 75 Ω. Connecting a cable releases this termination.

\*3 Since a connection to the through-out terminal releases the 75 Ω termination of the unit, the level of the VIDEO signal input to the unit may become too large depending on the connected device.

**3 DVI-I terminal**

This is the DVI-signal input terminal.

- Use double shielded cable for making connections to a DVI-I terminal.

**4 HDMI terminal (Type A)**

This is the HDMI input terminal.

- Use double-shielded cable for making connections to an HDMI terminal.

**5 AUDIO input terminal (pin jack)**

This is the common audio input terminal for all video input terminals.

- Use shielded cable for making connections to an AUDIO input terminal.

**6 RS-485 input/output terminal (RJ-45)**

External control is possible by using an RS-485 signal.

- Use shielded cable for making connections to an RS-485 input/output terminal.
- Make sure that the cable is fully inserted in the terminal and cannot easily be pulled out.
- A loop-through connection using the RS-485 input and output terminals allows operation of multiple monitors (up to 32 monitors).
- Connect a terminator (120 Ω) between the first and second pin of the RS-485 OUT terminal on the last monitor in the chain.

**7 GPI input terminal (D-SUB, 9 pins)**

External control is possible by using a GPI signal.

- Use shielded cable for making connections to the GPI input terminal.

**8 RS-232C input terminal (D-SUB, 9 pins)**

External control is possible by using an RS-232C signal

- Use shielded cable for making connections to an RS-232C input terminal.

# Power supply

## Connecting the power cable

1. Attach the power cable to the unit.

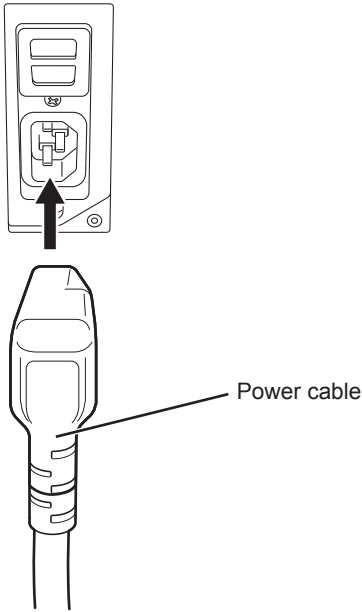

2. Connect the power cable to the power outlet.

### ■ When using external DC power (12 V DC)

You can slide open the power cover to switch from AC input to external DC input.

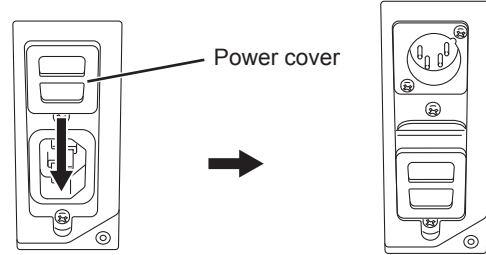

### <Note>

- If the power cover has come off or been removed, do not use the monitor with the power supply connected to both AC input and DC input terminals.
- Use a shielded DC cable that is not longer than 2 m. A cable that is 2 m or longer may cause screen noise.

Before using an external DC power supply, be sure to check that the rating of the external DC power supply suits the power requirements of this monitor.

Check the pin arrangements of the DC output terminal of the external DC power supply and those of the DC IN socket of this monitor to ensure that a connection will maintain the correct polarity.

If +12 V is accidentally connected the GND terminal, fire or injury could result.

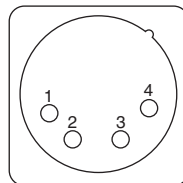

External DC input terminal

Pin number	Signal
1	GND
2, 3	—
4	+12 V

# Detaching and Attaching the Stand

The stand is detachable.

- When detaching and attaching the stand, it is recommended that you place the monitor flat on the edge of a desk or table with a soft cloth or similar material spread underneath.
- The stand is specifically designed for this monitor and cannot be used with other monitors. The stands supplied with the BT-LH1700W/1710/1760 series cannot be used with this unit.

## Detaching the stand

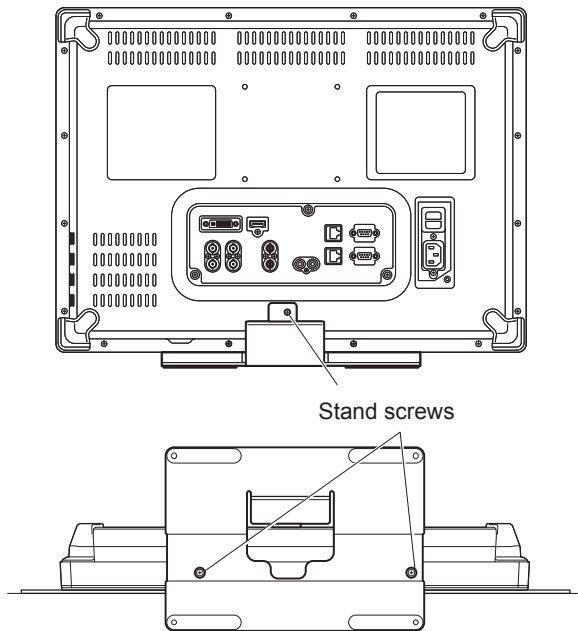

**Unscrew the stand screws (three) using a Phillips screwdriver.**

- After detaching, store the stand and the stand screws for the stand in a location easily accessible when required.

## Attaching the stand

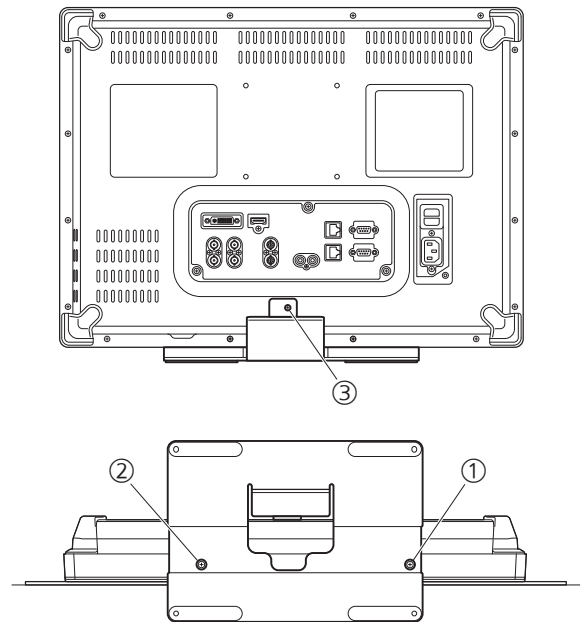

**1. Align the holes in the stand with those in the monitor.**

**2. Use a Phillips screwdriver to secure the stand to the monitor with the stand screws (three).**

- Install the stand screws in the (① to ③) order shown in the figure.



# On-screen Display

The screen shows the operation status display, the main menu (MAIN MENU) / FUNCTION menu / INPUT SELECT menu displays, picture adjusting (PICTURE) menu display, audio volume display, sharpness display, FUNCTION display, audio volume bar meter display, time code (TC) display, closed caption (CC) display, IMD (in monitor display) display and other information.

## Operating status display

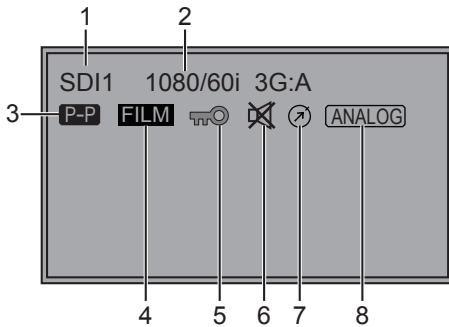

### <Note>

- Use [STATUS DISPLAY] in the [SYSTEM CONFIG] menu to set the display status. (→page 30)
- Icons meeting the 3 to 8 display requirements appear aligned to the left.
- [UNSUPPORT SIGNAL] and [NO SIGNAL] may not be properly displayed.
- For details on the display of names and signal formats of assist functions in 3D assist mode, refer to “3D Assist Mode” (→page49).  
In 3D assist mode, the various indications (4 to 8) can be displayed as well.

### 1. The selected input line (→pages 12 and 20)

- Displays [VIDEO], [SDI1], [SDI2], [HDMI], [DVI-I] ([YP<sub>B</sub>P<sub>R</sub>]/[RGB-COMP.]/[DVI-VIDEO]/[DVI-COMP.]) and [INT-SG].

### 2. Signal format

- [UNSUPPORT SIGNAL] appears if an unsupported signal is input.  
It may also indicate that the format selected in the [INPUT SELECT] menu does not match the input signal.
- [NO SIGNAL] appears when no signal is input.
- The level of a 3G-SDI signal input is displayed to the right of the signal format.

### 3. Various indications (PIXEL TO PIXEL mode)

- This indicates that the PIXEL TO PIXEL mode is engaged.

### 4. Various indications (FILM mode)

- This indicates that [GAMMA SELECT] in [VIDEO CONFIG] is set to [FILM].

### 5. Various indications (Lock setting)

- This indicates that the front operations are locked. (→page 48)

### 6. Various indications (mute indication)

- Indicates that the speaker and headphones are muted. (→page 21)

### 7. Various indications (indication of picture adjustment change)

- Indicates that picture adjustments ([PEAKING]/[PHASE]/[CHROMA]/[BRIGHT]/[CONTRAST]/[BACKLIGHT]) have been changed from the values assigned using [SETUP LOAD] or [POWER ON SETUP]. (→page 21)

### 8. Various indications (ANALOG mode)

- Indicates that the operating mode has been set to analog audio input using [INPUT SELECT] in the [AUDIO] menu.

## Main menu (MAIN MENU)/FUNCTION menu/INPUT SELECT menu displays

### 1. Press <MENU> when no menu is displayed.

- The [TOP MENU] appears.



### 2. Turn the rotary knob <PICTURE> to select a menu ([MAIN MENU], [FUNCTION], [INPUT SELECT]) and press the rotary knob <PICTURE>.

- For details on how to operate menus, refer to “How to Use the On Screen Menu” (→page20).
- In 3D assist and TWO WINDOW mode, the input is fixed to SDI1/SDI2 display and the [INPUT SELECT] menu cannot be selected.

#### [MAIN MENU]



#### [FUNCTION]

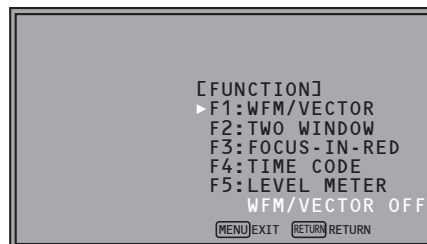

#### [INPUT SELECT]

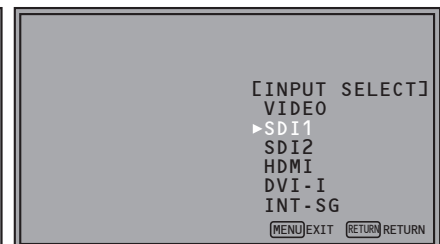

Displays instructions on <MENU> button operations.

## On-screen Display (continued)

### 3. To close a menu, press <MENU>.

- The menu display disappears after approx. 2 minutes of inaction. (The value shown before the display clears is confirmed.)

## Picture adjusting (PICTURE) menu display

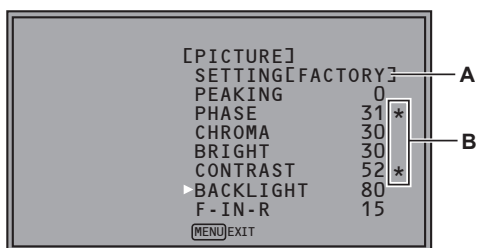

- A:** File names called by [SETUP LOAD] or [POWER ON SETUP] appear on the screen to the right of [SETTING].
- B:** When picture adjustments ([PEAKING]/[PHASE]/[CHROMA]/[BRIGHT]/[CONTRAST]/[BACKLIGHT]) have been changed from the values assigned using [SETUP LOAD] or [POWER ON SETUP], an asterisk (\*) appears to right of the menu name.

### 1. Press rotary knob <PICTURE> when no menu is displayed.

- The [PICTURE] (picture adjusting) menu appears.
- For details on how to operate menus, refer to "How to Use the On Screen Menu" (→page20).

### 2. To close a menu, press <MENU>.

- This display disappears after approx. 10 seconds of inaction. (The value shown before the display clears is confirmed.)

## Audio volume display

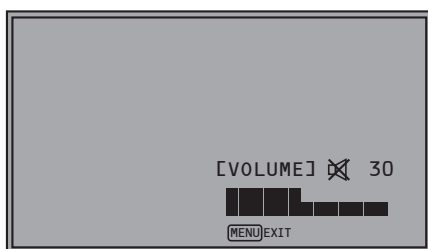

### 1. Press <RETURN / VOLUME> when no menu is displayed.

- The audio volume bar meter appears.
- For details on how to use the audio volume, refer to "How to Use the On Screen Menu" (→page20).

### 2. To close a menu, press <MENU> or the rotary knob <PICTURE>.

- This display disappears after approx. 10 seconds of inaction. (The value shown before the display clears is confirmed.)

## Sharpness display



- Indicates the [SHARPNESS H] and [SHARPNESS V] setting of the [VIDEO CONFIG] menu.
- When no operation is performed for approx. 2 minutes, the set value is confirmed and the display disappears.

## FUNCTION display

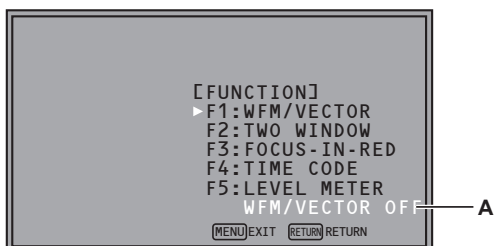

- Use the [FUNCTION] menu to set up functions.
- When [FUNCTION DISPLAY] (→page 35) is set to [ON1] or [ON2], press any of the <FUNCTION1> to <FUNCTION5> buttons to display the status of functions assigned to the FUNCTION buttons.
- When no operation is performed for approx. 2 seconds, the set value is confirmed and the display disappears.
- "A" indicates operating status. (→page37 "Functions displayed during FUNCTION button operation")

**Audio volume bar meter display**

● Normal operating mode

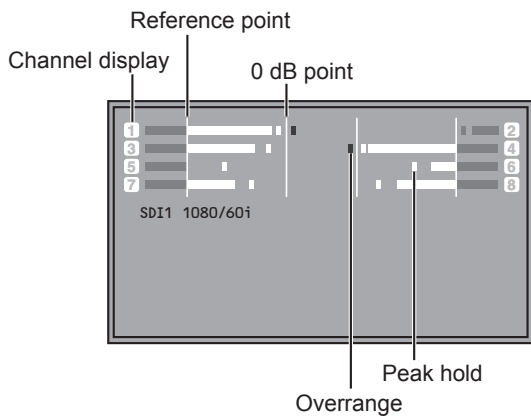

- A color bar meter indicates the audio level for SDI, HDMI and AUDIO signals.
- The display method of the audio volume bar meter can be set in the menu. (→page 45)
- In 3D assist mode, you can monitor the left (L) channel of SDI1 audio.
- In TWO WINDOW mode, it will display SDI1 and SDI2 in separate windows.

**Display color**

- Green: Up to reference point (included)
- Yellow: Reference point (not included) to 0 dB point (not included)
- Red: Overrange

● In TWO WINDOW mode

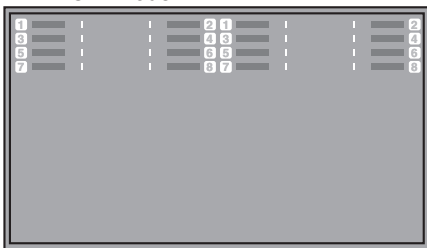

**Time code (TC) display**



(:) NDF  
(.) DF

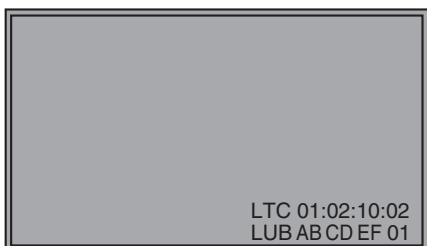
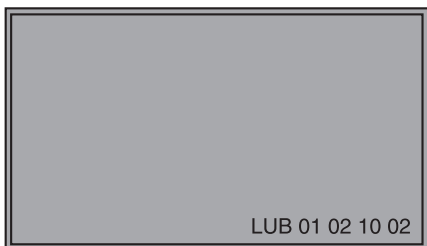

- Use the menu to display the time code for HD-SDI signal input. It also allows you to switch between display modes: ([LTC], [VITC], [LUB], [VUB], [LTC+LUB], [VITC+VUB]). (→page 46)

**In LTC and VITC display mode**

- Displays the time code in: hours: minutes: seconds: or frames.
- In drop-frame mode, a different delimiter is used between seconds and frames.

**<Note>**

Read errors are displayed as "--:--:--:--"

**In LUB and VUB display modes**

- BG8, BG7, BG6, BG5, BG4, BG3, BG2, BG1 appear in the stated order.  
BG: binary group
- The (:) delimiter does not appear.

**<Note>**

Read errors are displayed as "-- -- -- --"

**In LTC+LUB and VITC+VUB display modes**

Each combination is displayed separately.

**Closed caption (CC) display**

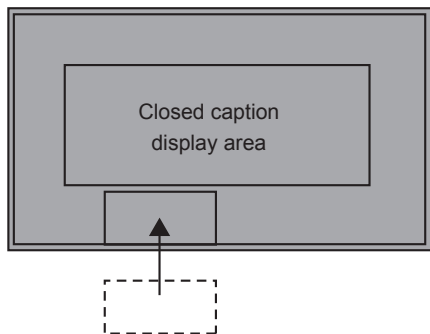

(When the specified window extends beyond the entire screen)

- This unit can display closed captions with an SDI or VIDEO signal input.
- Closed captions comply with the following standards.
  - Composite Standard EIA/CEA-608 (VBI), OP-42
  - SD-SDI CC Standard EIA/CEA-608 (ANC/VBI), OP-42
  - HD-SDI CC Standard EIA/CEA-608 (708), EIA/CEA-708, OP-47
- The EIA/CEA-708 Standard allows simultaneous display of closed captions at a specified location on up to eight windows.
- Closed captions are displayed on an area inside the screen that is smaller than the entire screen. (Refer to the following notes.)
- The display settings can be configured in the menus. The menu also allow you to select closed caption type, display channel (EIA/CEA-608) and display service (EIA/CEA-708). (→page 46)

**<Note>**

- The specified window position is displayed at a position in the display area according to the closed caption information.
- The window may extend beyond the display area depending on the position and size of the specified window. Such a window will be displayed but a window that extends beyond the entire screen will be repositioned inside the screen area.

**IMD (in monitor display) display**

● Normal operating mode

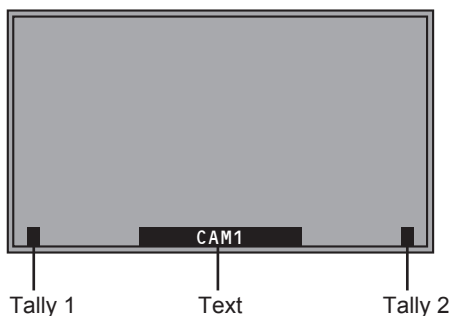

● In TWO WINDOW mode



- This monitor supports the TSL UMD PROTOCOL (Ver. 3.1 and Ver. 4.0) and allows you to display text and the tally indication on the monitor using the RS-485 interface.
- For information on how to set IMD and communications, refer to pages 47, 48, 63.
- In TWO WINDOW mode, it will display SDI1 and SDI2 in separate in monitor display (IMD) windows.

# How to Use the On Screen Menu

## Main menu (MAIN MENU)

- For details on how to open the main menu, refer to “Main menu (MAIN MENU)/FUNCTION menu/INPUT SELECT menu displays” (→page16).

1. Turn the rotary knob <PICTURE> to select a menu item and press the rotary knob <PICTURE>.



2. Turn the rotary knob <PICTURE> to select a submenu item and press the rotary knob <PICTURE>.

- The settings in the submenu change to green.

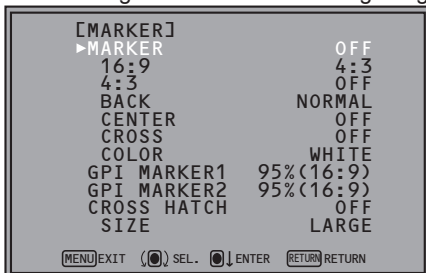

3. Turn the rotary knob <PICTURE> to select a set value and press the rotary knob <PICTURE>.

- To cancel, press <RETURN/VOLUME> before pressing the rotary knob <PICTURE>.

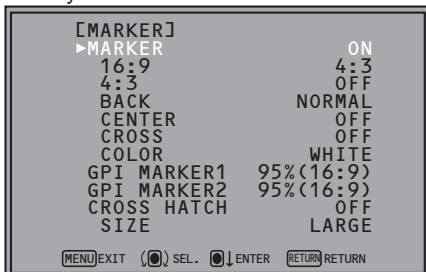

4. To return to the previous screen, press <RETURN/VOLUME>.

## FUNCTION menu

- For details on how to open the [FUNCTION] menu, refer to “Main menu (MAIN MENU)/FUNCTION menu/INPUT SELECT menu displays” (→page16).

1. Turn the rotary knob <PICTURE> to select a function item.

- Selected function item and set value appear in green.

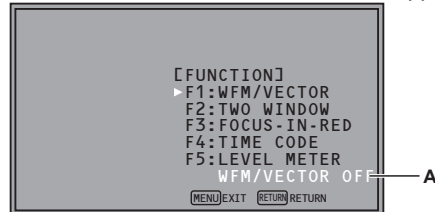

2. Press the rotary knob <PICTURE>.

- Each press of the rotary knob <PICTURE> changes the set value and enables function operation.

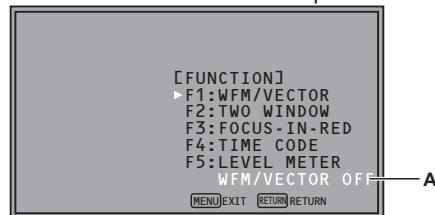

3. To return to the [TOP MENU], press <RETURN/VOLUME>.

## INPUT SELECT menu

- For details on how to open the [INPUT SELECT] menu, refer to “Main menu (MAIN MENU)/FUNCTION menu/INPUT SELECT menu displays” (→page16).

1. Turn the rotary knob <PICTURE> to select an input signal terminal or [INT-SG] and press the rotary knob <PICTURE>.

- To cancel, press <RETURN/VOLUME> before pressing the rotary knob <PICTURE>.

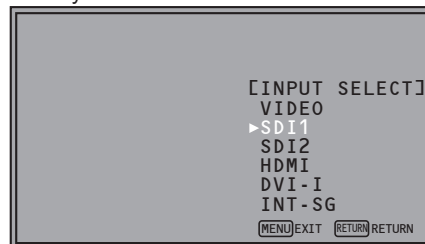

- VIDEO : Video input
- SDI1 : Serial digital interface input
- SDI2 : Serial digital interface input
- HDMI : HDMI input
- DVI-I\*1 : DVI-I input
- INT-SG\*2 : Internal chart for adjustment ([Color Bar + Grayscale]) (→page 77)

\*1 The name of the DVI-I input terminal is fixed at [DVI-I]. [INPUT NAME SETUP] in the [SYSTEM CONFIG] menu cannot be used to change names.

\*2 It is not possible to switch to [INT-SG] when two screens are displayed with the SUB WINDOW function(→page 38).

2. To return to the [TOP MENU], press <RETURN/VOLUME>.

## Picture adjusting (PICTURE) menu

1. Turn the rotary knob <PICTURE> to select a menu item and press the rotary knob <PICTURE>.

- The menu closes and the set values of the selected menu items appear.

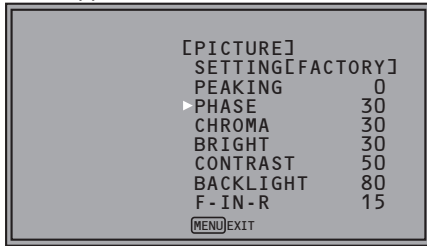

Name	Function	Adjustable range ( ): denotes factory defaults.
PEAKING	PEAKING	0 to 30 (0)
PHASE	PHASE	0 to 60 (30)
CHROMA	CHROMA	0 to 60 (30)
BRIGHT	BRIGHT	0 to 60 (30)
CONTRAST	CONTRAST	0 to 60 (50)
BACKLIGHT	BACKLIGHT	0 to 100 (80)
F-IN-R	FOCUS-IN-RED	1 to 30 (15)

The text color of set values that are factory defaults is green and other values are white.

Settings are loaded when the monitor is turned on. However, operations and changes cannot be made in the following conditions.

- When the control lock is on, the  mark appears and set values cannot be changed. (→page 48)
- When the [MONO] (→page 28) is set to [ON], [PHASE] and [CHROMA] operations are disabled.
- [F-IN-R] is enabled during operation of the FOCUS-IN-RED function.
- [BRIGHT] operation is disabled during [HV DELAY] (→page 34) operation (when it is in any other setting than OFF).
- [CONTRAST] and [BACKLIGHT] operations are disabled in [BLACK MODE] (→page 34).

2. Turn the rotary knob <PICTURE> to select a set value and press the rotary knob <PICTURE>.

- The set value is confirmed and the menu reappears.
- To cancel, press <RETURN/VOLUME> before pressing the rotary knob <PICTURE>.

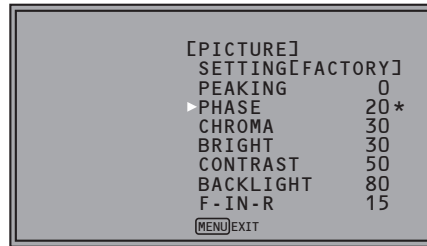
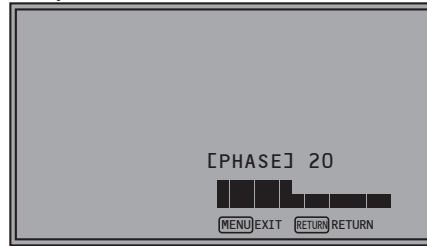



- When picture adjustments ([PEAKING]/[PHASE]/[CHROMA]/[BRIGHT]/[CONTRAST]/[BACKLIGHT]) have been changed from the values assigned using [SETUP LOAD] or [POWER ON SETUP], an asterisk (\*) appears to right of the menu name.

## Audio volume

- For details on how to use the audio volume, refer to "Audio volume display" (→page 17).

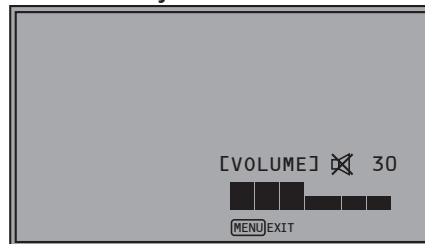
1. Turn the rotary knob <PICTURE> to select a set value.



- Set values are confirmed when they are changed.
- Changing the audio volume when audio output is muted ("AUDIO MUTE" (→page 35)) immediately cancels [AUDIO MUTE].
-  is displayed when audio output of the monitor is muted.
- Audio volume is always available and is not affected by the [CONTROL] menu (→page 48).
- The adjustment range is 0 to 60 (the factory default is 0)

# User Data

This monitor can save up to five combinations of set values for MAIN MENU and screen adjustments made in the [PICTURE] (picture adjusting) menu as user data that can be recalled.

You can also return set values and adjustments to their factory defaults.

User data include the following settings.

- Menu settings except [SETUP LOAD], [SETUP SAVE] and [REMOTE] in [CONTROL] (including button function settings on the monitor front panel)
- Screen adjustments made with the rotary knob <PICTURE>

## Saving user data

1. Press <MENU> to display the main menu.
2. Turn the rotary knob <PICTURE> to select the [SYSTEM CONFIG] menu and press the rotary knob <PICTURE>.
3. Turn the rotary knob <PICTURE> to select the [SETUP SAVE] submenu and press the rotary knob <PICTURE>. The set values in the submenu change to green.

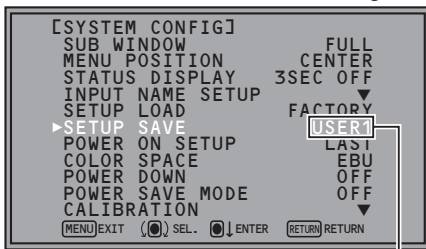

Changes to green

4. Turn the rotary knob <PICTURE> to select settings to save from the [USER1] to [USER5] and press the rotary knob <PICTURE>.

The following screen appears.



5. Select [YES] and press the rotary knob <PICTURE>. This saves the user data.

6. To return to the previous screen, press <RETURN/VOLUME>.

## Loading user data

1. Press <MENU> to display the main menu.
2. Turn the rotary knob <PICTURE> to select the [SYSTEM CONFIG] menu and press the rotary knob <PICTURE>.
3. Turn the rotary knob <PICTURE> to select the [SETUP LOAD] submenu and press the rotary knob <PICTURE>. The set values in the submenu change to green.

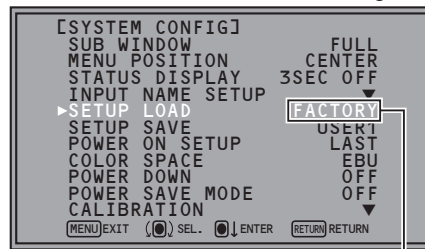

Changes to green

4. Turn the rotary knob <PICTURE> to select settings to call from the [USER1] to [USER5] and press the rotary knob <PICTURE>.

The following screen appears.

- To return to the factory defaults, select [FACTORY].

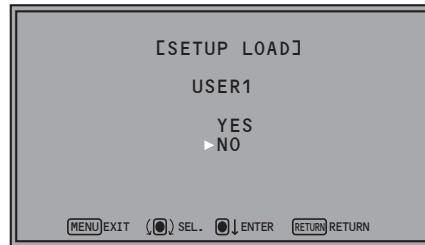

5. Select [YES] and press the rotary knob <PICTURE>. This loads the user data.

6. To return to the previous screen, press <RETURN/VOLUME>.



# Main Menu

## Menu configuration

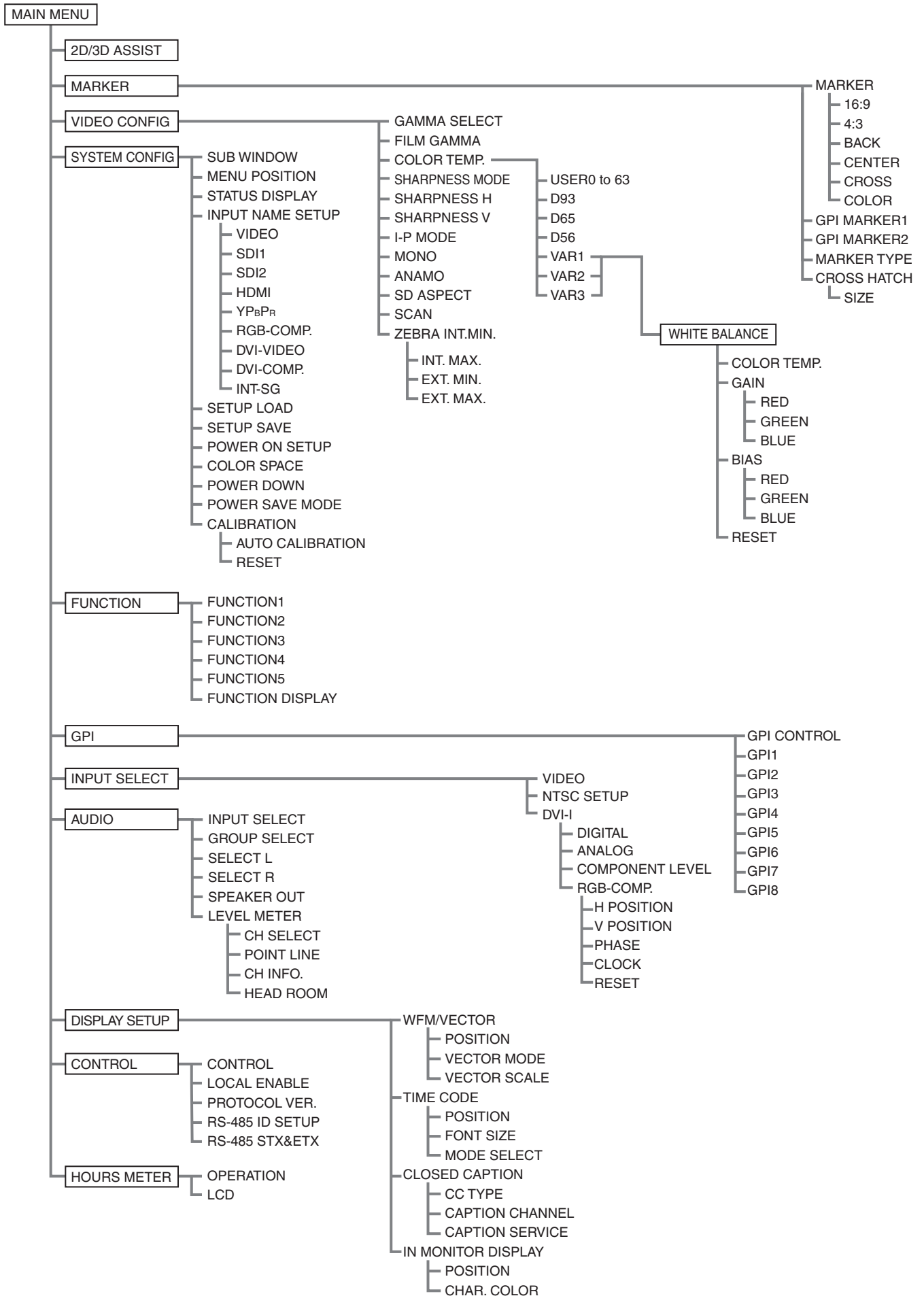

## 2D/3D ASSIST

Underlined values indicate factory defaults.

Setting	Description
<u>2D</u> 3D ASSIST	Switches between 2D mode and 3D assist mode. [2D] Operates in 2D mode. [3D ASSIST] Operates in 3D assist mode. When you switch to [3D ASSIST], the input line selection will be force switched to SDI1 or SDI2.

## MARKER

Underlined values indicate factory defaults.

Submenu	Setting	Description
<b>MARKER</b>	<u>OFF</u> *1 ON	Selects whether to enable or disable the marker setting.
<b>16:9</b> *2*3	<u>OFF</u> 4:3 13:9 14:9 CNSCO 2.39 CNSCO 2.35 2:1 VISTA 95% 93% 90% 88% 80% USER 85% VAR. H. 85% V. 85%	Selects/displays various markers in 16:9 aspect ratio. [OFF] No marker display [4:3] 4:3 marker [13:9] 13:9 marker [14:9] 14:9 marker [CNSCO 2.39] 2.39:1 marker [CNSCO 2.35] 2.35:1 marker [2:1] 2:1 marker [VISTA] VISTA marker [95%] 95 % area marker [93%] 93.1 % area marker (TYPE1) 93 % area marker (TYPE2) [90%] 90 % area marker [88%] 89.5 % area marker (TYPE1) 88 % area marker (TYPE2) [80%] 80 % area marker [USER] An area marker that is adjustable in 1% increments within a range of 80 to 100%. However, when the [MARKER TYPE] is [TYPE1], 88% and 93% indicate area markers whose height area 89.5% and 93.1%, respectively. (The factory default is 85 %.) [VAR.] This area marker can be varied in 1% increments in the range between 80 to 100% separately for vertical and horizontal. (The factory default is 85% for both vertical and horizontal)
<b>4:3</b> *2*4	<u>OFF</u> 95% 93% 90% 88% 80% USER 85% VAR. H. 85% V. 85%	Selects/displays the marker type for when the angle of view of the displayed image is 4:3. [OFF] No marker display [95%] 95 % area marker [93%] 93 % area marker [90%] 90 % area marker [88%] 89 % area marker (TYPE1) 88 % area marker (TYPE2) [80%] 80 % area marker [USER] An area marker that is adjustable in 1% increments within a range of 80 to 100%. However, when the [MARKER TYPE] is [TYPE1], 88 % indicates an area marker whose height is 89%. (The factory default is 85 %.) [VAR.] This area marker can be varied in 1% increments in the range between 80 to 100% separately for vertical and horizontal. (The factory default is 85% for both vertical and horizontal)
<b>BACK</b> *2	<u>NORMAL</u> HALF BLACK	Selects the background brightness around the marker. [NORMAL] Normal background [HALF] 50% signal level [BLACK] 0 % signal level (black)

\*1 This setting is turned [ON] when receiving marker control signals in REMOTE operation. (GPI if set, has priority.)

\*2 These settings are disabled when the GPI (→page 60) function is used to control the marker setting.

\*3 These settings are enabled only for HD and SD signal input when [SD ASPECT] is set to [16:9] aspect ratio mode. (→ 28 page "SD ASPECT")

\*4 These settings are enabled only for SD signal input when [SD ASPECT] is set to [4:3] aspect ratio mode. (→ 28 page "SD ASPECT")

## Main Menu (continued)

Submenu	Setting	Description
<b>CENTER*2</b>	OFF ON	Displays the center marker. [OFF] No marker display [ON] Turns the display on
<b>CROSS</b>	OFF (H. xxxx V. yyyy)	Displays the cross marker. [OFF] No marker display [(H. xxxx V. yyyy)] Displays the marker Horizontal (H: 20 to 1899), vertical (V: 20 to 1059) can be displayed for any location. When a set value [(H. xxxx V. yyyy)] has been confirmed, press the rotary knob <PICTURE> again to set horizontal and vertical positions. (The factory default is set to H: 480 V: 270.)
<b>COLOR</b>	WHITE BLACK RED GREEN BLUE	Selects a marker color. [WHITE] white [BLACK] black [RED] red [GREEN] green [BLUE] blue
<b>GPI MARKER1 *5</b>	4:3 13:9 14:9 CNSCO 2.39 CNSCO 2.35 2:1 VISTA 95% (16:9) 93% (16:9) 90% (16:9) 88% (16:9)	GPI MARKER 1 : Selects the marker displayed by the GPI terminal [MARKER1 ON/OFF] (→page 60) operation. GPI MARKER 2 : Selects the marker displayed by the GPI terminal [MARKER2 ON/OFF] (→page 60) operation. [4:3] 4:3 marker [13:9] 13:9 marker [14:9] 14:9 marker [CNSCO 2.39] 2.39:1 marker [CNSCO 2.35] 2.35:1 marker [2:1] 2:1 marker [VISTA] VISTA marker
<b>GPI MARKER2 *5</b>	80% (16:9) USER (16:9) VAR. (16:9) 95% (4:3) 93% (4:3) 90% (4:3) 88% (4:3) 80% (4:3) USER (4:3) VAR. (4:3)	[95% (16:9)] 95 % area marker for 16:9 aspect ratio [93% (16:9)] 93 % area marker for 16:9 aspect ratio [90% (16:9)] 90 % area marker for 16:9 aspect ratio [88% (16:9)] 88 % area marker for 16:9 aspect ratio [80% (16:9)] 80 % area marker for 16:9 aspect ratio [USER (16:9)] User set area marker for 16:9 aspect ratio*6 [VAR. (16:9)] VAR. set area marker for 16:9 aspect ratio*6 [95% (4:3)] 95 % area marker for 4:3 aspect ratio [93% (4:3)] 93 % area marker for 4:3 aspect ratio [90% (4:3)] 90 % area marker for 4:3 aspect ratio [88% (4:3)] 88 % area marker for 4:3 aspect ratio [80% (4:3)] 80 % area marker for 4:3 aspect ratio [USER (4:3)] User set area marker for 4:3 aspect ratio [VAR. (4:3)] VAR. set area marker for 4:3 aspect ratio
<b>MARKER TYPE *7</b>	TYPE1 TYPE2	Selects conventional monitor or camera recorder marker size. [TYPE1] Conventional monitor marker size [TYPE2] Marker size compliant with camera recorder (Panasonic camera)
<b>CROSS HATCH</b>	OFF LOW HIGH	Turns the cross hatch grid on and off and sets its density. [OFF] No cross hatch grid display [LOW] Displays a dim cross hatch grid [HIGH] Displays a bright cross hatch grid
<b>SIZE</b>	SMALL LARGE	Selects the cross hatch grid size. [SMALL] 60 dots and 60 lines [LARGE] 120 dots and 120 lines

\*2 These settings are disabled when the GPI (→page 60) function is used to control the marker setting.

\*5 Remote control via RS-232C or RS-485 ends in error (error response: ER001) when [GPI MARKER1] or [GPI MARKER2] is selected with the GPI function.

\*6 Since video is displayed at 100%, the marker will not be visible if set to [100%].

\*7 Display size for SD signals differ.

TYPE1: The effective horizontal area meets the SMPTE ST125 for NTSC and ITU-R BT.601-5 for PAL.

TYPE2: The effective horizontal area meets the EIA-RS170A for NTSC and ITU-R BT.470-4 for PAL.

### <Note>

• Markers other than the CROSS HATCH marker are not available during 2-screen display, PIXEL TO PIXEL mode, and 3D assist mode.

**MARKER types**

■ **16:9 marker**

(Displayed for HD input and SD input in 16:9 ratio mode.)  
The marker is only displayed as a vertical bar. In addition, the  section becomes the "MARKER BACK" item.

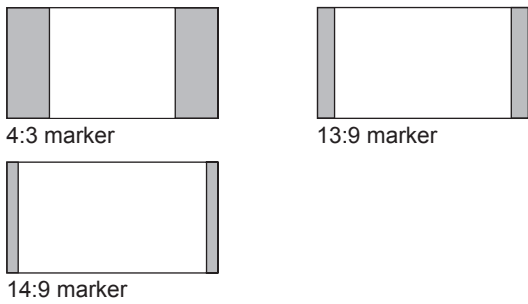

■ **VISTA marker, 2:1 marker, CNSCO marker**

A horizontal dotted line is displayed as the marker.

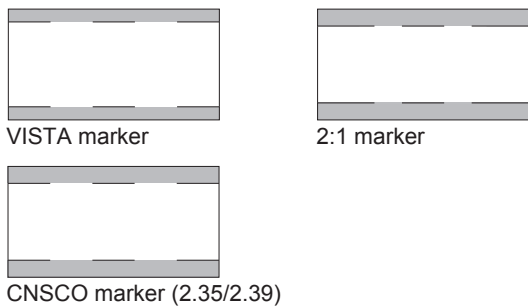

The vertical dotted lines are also displayed as the marker when [UNDER] is selected under [SCAN] in the [VIDEO CONFIG] menu.

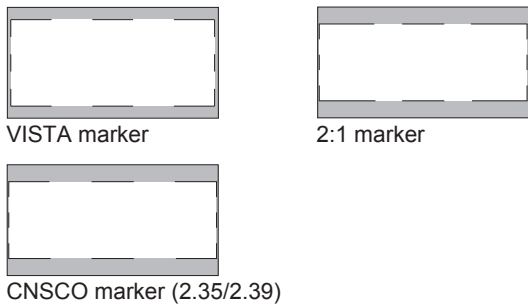

■ **Area marker**

This marker is displayed as a dotted line.

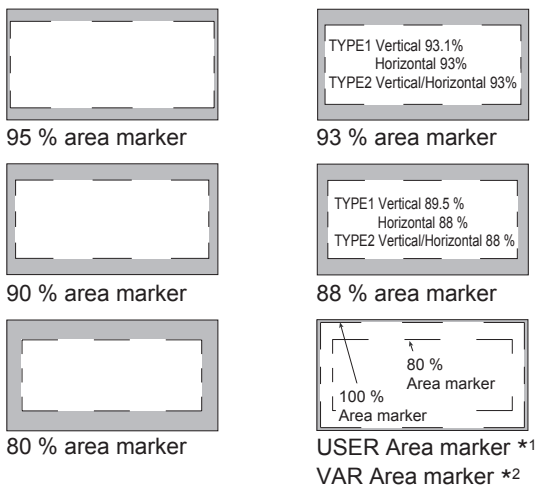

■ **4:3 marker**

(Displayed for SD input in 4:3 aspect ratio mode)  
This marker is displayed as a dotted line.

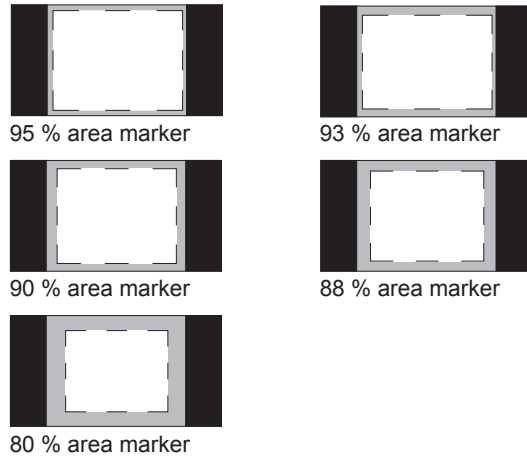

(Displayed for HD input and SD input in 16:9 ratio mode.)  
This marker is displayed as a dotted line.

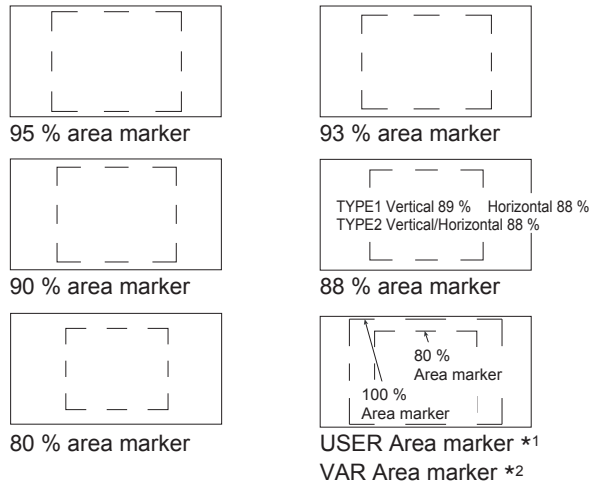

**You can display the 4:3 marker and the 16:9 marker simultaneously.**

Simultaneous display example

The  area becomes the "MARKER BACK".

It controls the background of the marker selected with a 16:9 ratio.

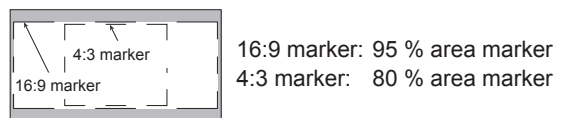

■ **Center marker**

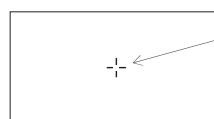

Center marker  
This marker is displayed at the center of the screen.

■ **Cross marker**



Cross marker  
Use the rotary knob <PICTURE> to move. (The cross marker is half the length of the center marker and twice the width)

\*1 Use the rotary knob <PICTURE> to set 80 to 100% in 1% increments.

\*2 Use the rotary knob <PICTURE> to set 80 to 100% in 1% increments separately for vertical and horizontal.

## VIDEO CONFIG

The underlined values are factory defaults.

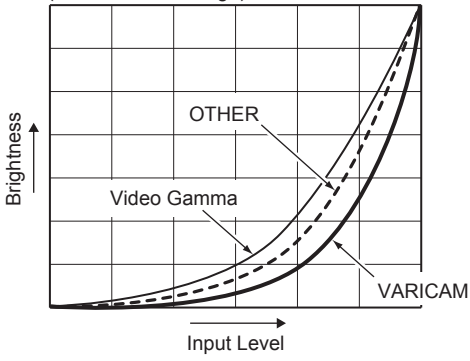
Submenu	Setting	Description
<b>GAMMA SELECT</b> *1*2	STANDARD FILM <u>STDIO/PST</u> CINEMA	Selects gamma curve. [STANDARD] Standard mode (power of 2.2) [FILM] Film mode [STDIO/PST] Color emphasis mode (power of 2.35) [CINEMA] CINEMA mode (power of 2.6) • When [FILM] is selected, the <b>FILM</b> mark is displayed for the operating status.
<b>FILM GAMMA</b>	<u>VARICAM</u> OTHER	Selects type of FILM gamma mode. [VARICAM] For VARICAM use [OTHER] For other cameras  (Gamma curve image)  The graph shows three curves: 'Video Gamma' (solid line), 'OTHER' (dashed line), and 'VARICAM' (dotted line). The y-axis is 'Brightness' and the x-axis is 'Input Level'. 'Video Gamma' is the steepest curve, 'OTHER' is the middle curve, and 'VARICAM' is the least steep curve.
<b>COLOR TEMP.</b>	USER 0 to 63*3 D93 <u>D65</u> D56 VAR1 VAR2 VAR3	Selects color temperature. [USER 0 to 63] Adjustable settings 0 to 63 (equivalent to a color temperature range of 3,000 K to 9,300 K) [D93] Equivalent to a color temperature of 9,300 K [D65] Equivalent to a color temperature of 6,500K [D56] Equivalent to a color temperature of 5,600 K [VAR1] WB (White Balance) adjustment mode *4 [VAR2] WB (White Balance) adjustment mode *4 [VAR3] WB (White Balance) adjustment mode *4
<b>SHARPNESS MODE</b> *5 *6	HIGH LOW	Selects the width of outline correction edge. [HIGH] Narrow edge [LOW] Wide edge
<b>SHARPNESS H</b> *5 *6	0 to 30	Sets horizontal outline correction. The item display moves to the lower part of the screen during adjustment.
<b>SHARPNESS V</b> *5 *6	0 to 30	Sets vertical outline correction. The item display moves to the lower part of the screen during adjustment.

\*1 When the SUB WINDOW function is used, changes are not reflected to the still image in the main window.

\*2 This menu is grayed out when the same item is assigned to GPI and [GPI CONTROL] is set to [ENABLE].

\*3 To select [USER 0 to 63]

① Press the rotary knob &lt;PICTURE&gt;. ([USER] changes to blue)

② Use the rotary knob &lt;PICTURE&gt; to select 0 to 63 and press the rotary knob &lt;PICTURE&gt;.

\*4 Selecting [VAR1], [VAR2] or [VAR3] engages the WB adjustment mode. (→page 29)

\*5 The following sharpness values

① VIDEO system input (VIDEO) (the factory defaults are SHARPNESS MODE: LOW and SHARPNESS H/SHARPNESS V: 0)

② HD inputs other than ① above (the factory defaults are SHARPNESS MODE: HIGH and SHARPNESS H/SHARPNESS V: 0).

③ SD inputs other than ① above (the factory defaults are SHARPNESS MODE: LOW and SHARPNESS H/SHARPNESS V: 0).

are available and the settings for the selected input signal is displayed. During selection, adjustment status is displayed below the [PICTURE] (picture adjusting) menu.

\*6 When HD signals are input via SDI1 and SD signals via SDI2 or SD signals via SDI1 and HD signals via SDI2 in TWO WINDOW or PICTURE ASSIST function operation, changes in the sharpness setting from the menu affect only the left screen.

(Continued on next page)

## Main Menu (continued)

Submenu	Setting	Description
<b>I-P MODE</b> *7	MODE1 MODE2	Selects IP conversion mode. (see "IP mode" (→This page).) [MODE1] Intra-frame interpolation [MODE2] Intra-field interpolation
<b>MONO</b> *2	OFF ON	Switches between color and monochrome (MONO). [OFF] Color [ON] Monochrome • When [ON], the [CHROMA] setting of the [PICTURE] (picture adjusting) menu is fixed at 0.
<b>ANAMO</b> *8	OFF ON	With an Anamo lens and HD-SDI input, the picture is resized to Anamo magnification. (the vertically enlarged signal can be vertically compressed and corrected for display).
<b>SD ASPECT</b> *2	4:3 16:9	Sets the aspect ratio for SD signal input. [4:3] 4:3 display [16:9] 16:9 display
<b>SCAN</b> *2*8	NORMAL UNDER	Sets under-scan and normal display. [NORMAL] Normal display [UNDER] Under-scan
<b>ZEBRA INT. MIN.</b> *9	-7% to 108% (Factory default setting: <u>70%</u> )	Sets the range of the ZEBRA function. Displays the minimum value of the INT. range as a percentage of the video signal.
<b>INT. MAX.</b> *9	-6% to 109% (Factory default setting: <u>85%</u> )	Sets the range of the ZEBRA function. Displays the maximum value of the INT. range as a percentage of the video signal.
<b>EXT. MIN.</b> *9	-7% to 108% (Factory default setting: <u>5%</u> )	Sets the range of the ZEBRA function. Displays the minimum value of the EXT. range as a percentage of the video signal.
<b>EXT. MAX.</b> *9	-6% to 109% (Factory default setting: <u>100%</u> )	Sets the range of the ZEBRA function. Displays the maximum value of the EXT. range as a percentage of the video signal.

\*2 This menu is grayed out when the same item is assigned to GPI and [GPI CONTROL] is set to [ENABLE].

\*7 To use the SUB WINDOW (→page 38) function,

- ① Change settings after exiting the SUB WINDOW function.
- ② It is recommended to use [MODE2] for handling fast video.

\*8 [SCAN] changes are not reflected in Anamo size display.

\*9 The ZEBRA function must be set according to the following conditions.

- [INT. MIN.] < [INT. MAX.]
- [EXT. MIN.] < [EXT. MAX.]
- [EXT. MIN.] ≤ [INT. MIN.]
- [INT. MAX.] ≤ [EXT. MAX.]

### IP mode

[MODE1] performs IP conversion using intra-frame interpolation.

This monitor suppresses the delay to within 1 field.

The factory default is [MODE1].

[MODE2] performs IP conversion using intra-field interpolation.

Since interpolation is performed inside each field, this mode is suitable for checking interlace status.

## Main Menu (continued)

### WB (WHITE BALANCE) adjustment mode

Select [VAR1] to [VAR3] for [COLOR TEMP.] in the [VIDEO CONFIG] menu to make WHITE BALANCE VAR1 to WHITE BALANCE VAR3 adjustments.

Underlined values indicate factory defaults.

Submenu	Setting	Description
<b>COLOR TEMP.</b> <sup>*10</sup>	USER 0 to 63 D93 <u>D65</u> D56	Selects the color temperature that will become the basis for adjustment. [USER 0 to 63] Adjustable settings 0 to 63 (equivalent to a color temperature range of 3,000 K to 9,300 K) [D93] Equivalent to a color temperature of 9,300 K [D65] Equivalent to a color temperature of 6,500K [D56] Equivalent to a color temperature of 5,600 K
<b>GAIN</b>	▼	Adjusts the GAIN elements Press the rotary knob <PICTURE> to switch to RGB direct adjustment mode. (This allows you to begin adjusting GAIN first.)
<b>RED</b>	0 to 1023 (A color temperature of [D65] is the factory default value.) • This is a factory default adjustment.	Displays the GAIN elements for RED. (For numerical value confirmation)
<b>GREEN</b>		Displays the GAIN elements for GREEN. (For numerical value confirmation)
<b>BLUE</b>		Displays the GAIN elements for BLUE. (For numerical value confirmation)
<b>BIAS</b>	▼	Adjusts the BIAS elements Press the rotary knob <PICTURE> to switch to RGB direct adjustment mode. (This allows you to begin adjusting BIAS first.)
<b>RED</b>	- 512 to 511 (Factory default setting: <u>0</u> )	Displays the BIAS elements for RED. (For numerical value confirmation)
<b>GREEN</b>		Displays the BIAS elements for GREEN. (For numerical value confirmation)
<b>BLUE</b>		Displays the BIAS elements for BLUE. (For numerical value confirmation)
<b>RESET</b>	▼	Resets [GAIN] (RED/GREEN/BLUE) and [BIAS] (RED/GREEN/BLUE) set values to color temperature values selected under [COLOR TEMP.].

<sup>\*10</sup>Selecting [COLOR TEMP.] and pressing the rotary knob <PICTURE> after selecting an item, opens a confirmation screen. When you select [YES] and press the rotary knob <PICTURE> in this screen, the selected GAIN and BIAS values are reset to the selected color temperature values.

### Direct adjustment mode

Press the rotary knob <PICTURE> when a [GAIN], [BIAS] or ZEBRA LEVEL item is selected in the WHITE BALANCE VAR (1 to 3) menu, to switch to the adjusting screen and use the rotary knob <PICTURE> to directly adjust the picture while checking the screen. When [WHITE BALANCE] and [ZEBRA LEVEL] are assigned to FUNCTION1 to FUNCTION5, you can access them using the <FUNCTION> buttons or the [FUNCTION] menu.

#### WB adjustment screen

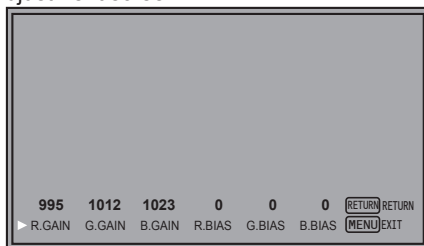

#### ZEBRA LEVEL adjustment screen

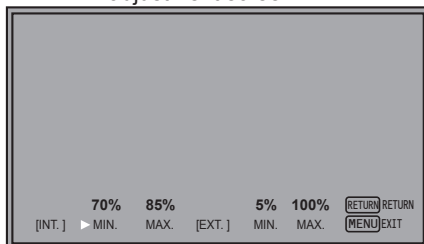

#### Operation procedure

1. Turn the rotary knob <PICTURE> left or right to select an item to change and press the rotary knob <PICTURE>.
2. Turn the rotary knob <PICTURE> left or right to make changes.
  - Press the rotary knob <PICTURE> to confirm the adjusted values.

#### <Note>

- Press the <MENU> button in this adjusting screen to return to a normal screen without a menu. <sup>\*11</sup>  
When the button is pressed before the values are confirmed, they will not be confirmed.
- Pressing <RETURN/VOLUME> in this adjusting screen will return you to the previous cursor and screen.  
When the <RETURN/VOLUME> is pressed before the values are confirmed, they will not be confirmed.

• The above two screens cannot be recalled by using the <FUNCTION> button to access [RETURN].

<sup>\*11</sup>A transition to the previous menu is also made if the monitor is left idle for 10 seconds. However, when called using a <FUNCTION> button, a normal screen without a menu reappears.



## SYSTEM CONFIG

Underlined values indicate factory defaults.

Submenu	Setting	Description
<b>SUB WINDOW</b>	<u>FULL</u> PART	Selects sub-window type of the SUB WINDOW function. [ <u>FULL</u> ] Reduces the entire input signal screen and turns it into two screens that are displayed side by side. [PART] Removes the center portion of the input signal screen and turns it into two screens that are placed side by side. (The center portion is displayed at its original size)
<b>MENU POSITION</b>	<u>CENTER</u> LT RT RB LB	Positions the on-screen menu. [ <u>CENTER</u> ] Center of screen [LT] Top left [RT] Top right [RB] Bottom right [LB] Bottom left
<b>STATUS DISPLAY</b>	OFF <u>3SEC OFF</u> CONTINUE	Determines how operating status (→page 16) is displayed. [OFF] Not displayed. [3SEC OFF] Displayed for approx.3 seconds after a status change. *1 [CONTINUE] Displayed at all times.
<b>INPUT NAME SETUP</b>	▼	Changes the names of displayed input terminals in status display screens. *2
<b>SETUP LOAD</b>	<u>FACTORY</u> USER1 *3 USER2 *3 USER3 *3 USER4 *3 USER5 *3	Loads saved factory defaults ([FACTORY]) or user data ([USER1] to [USER5]).(→page 22) After loading user data, the screen displays the signal selected before user data was loaded.
<b>SETUP SAVE</b>	<u>USER1</u> USER2 USER3 USER4 USER5	Up to 5 sets of user data can be saved.(→page 22) Adjustment values made with the rotary knob <PICTURE> and menu settings, except [SETUP SAVE]/[SETUP LOAD] can be saved.
<b>POWER ON SETUP</b>	<u>LAST</u> FACTORY USER1 USER2 USER3 USER4 USER5	Selects the settings used when the power is turned on. [ <u>LAST</u> ] Starts in the mode used when the power was last turned off. [FACTORY] Starts up using the factory defaults. [USER1] to [USER5] Starts up using USER registered settings.
<b>COLOR SPACE</b>	<u>SMPTE-C</u> *4 <u>EBU</u> *5 ITU-709 *6	Sets the studio standard color shade.
<b>POWER DOWN</b>	OFF ON	Determines whether or not the power will be turned off (powered down) when there is no signal input and the monitor has been idle for a certain period of time. [OFF] The monitor is not powered down. [ON] The monitor is powered down.
<b>POWER SAVE MODE</b>	<u>OFF</u> ON	Sets the power save mode [OFF] POWER SAVE MODE is not engaged. [ON] The backlight dims when no signal ([NO SIGNAL]) is input for approx.60 seconds or longer. Signal input or menu operation will return the backlight to its normal brightness.
<b>CALIBRATION</b>	▼	Connect a CA-310 Display color analyzer and use this submenu to make a calibration. This also restores the calibration data to factory defaults.(→pages 32 to 33)

\*1 In PIXEL TO PIXEL and 3D assist mode, the [3SEC OFF] setting has the same effect as [CONTINUE].

\*2 Up to 9 characters can be entered for this monitor. Only alphabetic characters (English), numeric characters and symbols can be used.

\*3 [USER1] to [USER 5] and [FACTORY] have the same factory defaults.

\*4 Factory default setting for the BT-LH2170P.

\*5 Factory default setting for the BT-LH2170E.

\*6 ITU-709 is an ITU-R BT.709 standard.

■ INPUT NAME SETUP

The INPUT NAME SETUP function allows you to change the names of the ([VIDEO], [SDI1], [SDI2], [HDMI], [DVI-I] ([YP<sub>B</sub>P<sub>R</sub>]/[RGB-COMP.]/[DVI-VIDEO]/[DVI-COMP.]), [INT-SG]) input lines that are displayed in the status display or other indications.

1. Turn the rotary knob <PICTURE> in the [SYSTEM CON-FIG] menu to select the [INPUT NAME SETUP] submenu and press the rotary knob <PICTURE>.

2. Turn the rotary knob <PICTURE> to select the name of the input line you want to change and press the rotary knob <PICTURE>.



3. Turn the rotary knob <PICTURE> to select the characters you want to change\*7 and press the rotary knob <PICTURE> to confirm them.

- The selected characters are highlighted and change to italics when confirmed.

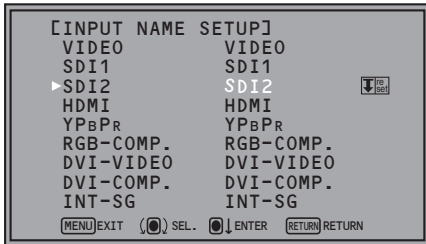

\*7 The "B" and "R" in YP<sub>B</sub>P<sub>R</sub> cannot be selected.

4. Turn the rotary knob <PICTURE> to enter the characters and press the rotary knob <PICTURE> to confirm them.

- After entering all display characters, select [RESEL] and press the rotary knob <PICTURE> to confirm them.



- Selecting [RESEL] and pressing the rotary knob <PICTURE> cancels the entered characters and returns them to their default values.

- To cancel a setting, press the rotary knob <PICTURE> before pressing the rotary knob <PICTURE> to enter the display characters.

## Main Menu (continued)

### ■ CALIBRATION

The CALIBRATION function in this monitor measures LCD panel characteristics from low to high brightness values and uses internal monitor processing to handle calibration.

Calibration is performed using internal signals and do not rely on image quality settings. This monitor uses a color temperature of D65 for calibration and other color temperatures are derived from this value.

### ■ Equipment required for CALIBRATION

- Konica Minolta CA-310 display color analyzer (optional accessory)
- Konica Minolta CA-PU12 or CA-PU15 standard measurement probe (optional accessory)
- A RS-232C cable (male to male, straight) (optional accessory)

Connect the RS-232C input terminal on the monitor to the RS-232C terminal on the display color analyzer.

Use a straight cable.

- Set the Baud rate of the display color analyzer to 38,400.

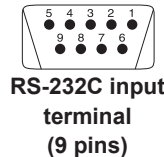
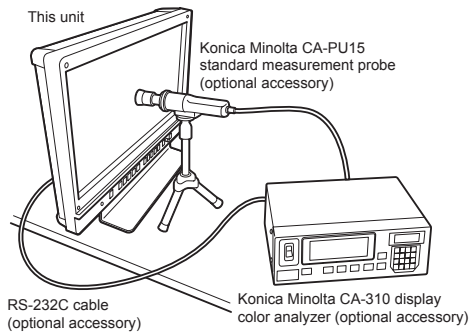

Analyzer Side		(Straight)	On the monitor	
Pin number	Signal		Pin number	Signal
1	CD		1	N.C.
2	RXD	←	2	TXD
3	TXD	→	3	RXD
4	DTR	→	4	DSR
5	GND	—	5	GND
6	DSR	←	6	DTR
7	RTS	→	7	CTS
8	CTS	←	8	RTS
9	GND		9	N.C.

- Turn on this monitor and perform adequate aging (about 1 hour) before starting calibration.
- Make the room dark so that no external light can enter the standard measurement probe before starting the calibration. When external light enters the probe, the low brightness characteristics may not be calibrated correctly.
- LCD panel characteristics and instrument error in the display color analyzer may sometimes result in small differences in values after calibration.

To further fine tune the monitor, set GAIN and BIAS for R, G and B in the VAR mode of [COLOR TEMP.].

- Do not apply the probe to a WFM/VECTOR display on the screen.
- When you are using CA-210, contact your supplier.

### ■ CALIBRATION

Select [CALIBRATION] in the [SYSTEM CONFIG] menu to open the following menus.

Submenu	Setting	Description
<b>AUTO CALIBRATION</b> *8	▼	Connect a CA-310 Display color analyzer and use this submenu to make a calibration. Select [AUTO CALIBRATION] and select [YES] in the confirmation screen that appears to start calibration.
<b>RESET</b> *9	▼	Returns calibration data to their factory defaults. Select [RESET] and select [YES] in the confirmation screen that appears to return calibrated values to their factory defaults.

\*8 [EXECUTING] is displayed during AUTO CALIBRATION and [COMPLETE] appears when calibration ends. [INCOMPLETE] appears if calibration could not be completed.

\*9 When RESET ends, [COMPLETE] appears.

**Performing AUTO CALIBRATION**

1. Turn the rotary knob <PICTURE> in the [SYSTEM CONFIG] menu to select the [CALIBRATION] submenu and press the rotary knob <PICTURE>.

2. Turn the rotary knob <PICTURE> to select the [AUTO CALIBRATION] submenu and press the rotary knob <PICTURE>.



3. Select [YES] and press the rotary knob <PICTURE>. This starts calibration.



xxxxxxxx indicates that the following message with the meaning listed below appears.  
EXECUTING: Operation in progress  
COMPLETE: Operation completed  
INCOMPLETE: Operation incomplete (Check the RS-232C connection or display color analyzer connection.)

4. Turn the power off and then on after performing auto calibration.

**RESET operation**

1. Turn the rotary knob <PICTURE> in the [SYSTEM CONFIG] menu to select the [CALIBRATION] submenu and press the rotary knob <PICTURE>.

2. Turn the rotary knob <PICTURE> to select the [RESET] submenu and press the rotary knob <PICTURE>.



3. Select [YES] and press the rotary knob <PICTURE>. This starts calibration.



xxxxxxxx indication.  
COMPLETE: Operation completed

4. Turn the power off and then on after performing auto calibration.

## FUNCTION

Underlined values indicate factory defaults.

Submenu	Setting	Description	
FUNCTION1 - FUNCTION5	HV DELAY	Selects functions to be assigned to <FUNCTION1> - <FUNCTION5> (front panel buttons or the [FUNCTION] menu).	
	BLUE ONLY	[HV DELAY] *1 This displays the blanking period. The display changes in the following order. [DELAY OFF] → [H DELAY] → [V DELAY] → [HV DELAY]	
	GAMMA SELECT	[BLUE ONLY] *1 Cuts the red and green signals. Use this function to check phase (PHASE) and chroma (CHROMA). This button toggles between ON and OFF.	
	SD ASPECT	[GAMMA SELECT] *2*3 Displays the gamma curve. The display changes in the following order. [GAMMA STANDARD] → [GAMMA FILM] → [GAMMA STUDIO/PST] → [GAMMA CINEMA]	
	SCAN	[SD ASPECT] *2*3 Switches between [16:9] and [4:3].	
	SUB WINDOW	[SCAN] *2*3 Switches between [UNDER SCAN] and [NORMAL SCAN].	
	WFM/VECTOR	[SUB WINDOW] *1 Sets the split-screen function. The display changes in the following order. [SINGLE] → [FULL/PART] → [STILL]	
	MARKER	[WFM/VECTOR] *2 Displays waveform or vector display. For details on the available operation items, refer to page 36.	
	WHITE BALANCE	[MARKER] *2*3*4 Display the marker. For details on the available operation items, refer to page 36.	
	PIXEL TO PIXEL	[WHITE BALANCE] RGB can be directly adjusted under [GAIN]/[BIAS] in WHITE BALANCE only when [VAR1] to [VAR3] are selected under [COLOR TEMP.].	
	PIXEL POSITION	[PIXEL TO PIXEL] Turns the PIXEL TO PIXEL function On and Off.	
	FOCUS-IN-RED	[PIXEL POSITION] Positions the display of signals when PIXEL TO PIXEL is on. The display changes in the following order. [PIXEL TO PIXEL LEFT] → [PIXEL TO PIXEL CENTER] → [PIXEL TO PIXEL RIGHT]	
	LEVEL METER	[FOCUS-IN-RED] *3*5 Turns On/Off the function that highlights in red the portion of the image that is being focused.	
	CROSS HATCH	[LEVEL METER] *2 Turns the audio volume bar meter display On and Off.	
	MONO	[CROSS HATCH] *2 Displays the cross hatch grid. The display changes in the following order. [CROSS HATCH OFF] → [CROSS HATCH LOW] → [CROSS HATCH HIGH]	
	BLACK MODE	[MONO] *2*3 Switches between color and monochrome.	
		[BLACK MODE] *1*6 This mode is for correcting black level errors and checking the gradation of dark areas. The brightness of the backlight is reduced and the contrast is increased so that up to 75 % of the input signal level has the same gamma curve as the [GAMMA SELECT] setting. The signal level of 75% or higher is clipped.	
		(Factory defaults FUNCTION1: <u>WFM/VECTOR</u> FUNCTION2: <u>TWO WINDOW</u> FUNCTION3: <u>FOCUS-IN-RED</u> FUNCTION4: <u>TIME CODE</u> FUNCTION5: <u>LEVEL METER</u> )	

\*1 The settings are canceled when the power is turned OFF.

\*2 When these settings are changed, the menu settings will also change.

\*3 The control settings do not operate during GPI operation.

\*4 Not displayed when [16:9], [4:3] and [CENTER] are all [OFF] in the [MARKER] menu settings.

\*5 During FOCUS-IN-RED operation, use the rotary knob &lt;PICTURE&gt; to change the detection sensitivity.

The setting range is from 1 to 30, with a higher numerical value resulting in higher detection sensitivity (the focus becomes less sharp).

\*6 The bright picture is clipped. The back light and contrast cannot be adjusted.

## Main Menu (continued)

Submenu	Setting	Description
(continued from the previous page)		<p>[TIME CODE] *2 Turns the time code display on and off.</p> <p>[CLOSED CAPTION] *2 Turns the closed caption display on and off. For details on the available operation items, refer to page 37.</p> <p>[AUDIO MUTE] Turns the audio MUTE function on and off.</p> <p>[AUDIO OUT SEL.] Switches AUDIO output to SDI1 or SDI2 during TWO WINDOW function operation.</p> <p>[ANAMO] Turns the ANAMO function on and off.</p> <p>[TWO WINDOW] Turns the TWO WINDOW function on and off.</p> <p>[Y MAP] Turns the Y MAP function on and off.</p> <p>[PICTURE ASSIST]*1 Turns the PICTURE ASSIST function on and off.</p> <p>[R COLOR]*7 Cuts the red signals. This button toggles between ON and OFF.</p> <p>[G COLOR]*7 Cuts the green signals. This button toggles between ON and OFF.</p> <p>[B COLOR]*7 Cuts the blue signals. This button toggles between ON and OFF.</p> <p>[ZEBRA]*3 Selects the ZEBRA function. The display changes in the following order. [ZEBRA OFF]→[ZEBRA INT.]→[ZEBRA EXT.]→[ZEBRA INT.+EXT.]</p> <p>[ZEBRA LEVEL] Displays the screen for adjusting the ZEBRA function.</p> <p>[2D/3D ASSIST] Switches between 2D and 3D assist mode.</p> <p>[UNDEF] Undefined</p>
<b>FUNCTION DISPLAY</b> *8	OFF ON1 <u>ON2</u> *9	<p>Selects display of functions assigned to &lt;FUNCTION1&gt; - &lt;FUNCTION5&gt; (front panel buttons). It also selects button action (1- touch, 2-touch, off).</p> <p>[OFF] 1-touch action to perform functions. Functions are not displayed.</p> <p>[ON1] 1-touch action to display and perform functions.</p> <p>[ON2] 2-touch action to display and perform functions.</p>

• Pressing the <FUNCTION1> to <FUNCTION5> buttons will not activate FUNCTION operation when the [PICTURE] (picture adjusting) menu has been opened with the rotary knob <PICTURE>.

\*1 The settings are canceled when the power is turned OFF.

\*2 When these settings are changed, the menu settings will also change.

\*3 The control settings do not operate during GPI operation.

\*7 The OFF setting is canceled (ON setting) when the power is turned OFF .

\*8 The operating status is displayed regardless of the ON/OFF setting.

\*9 When set to [ON2], only functions that are displayed can be button operated.

### ■ FUNCTION setting restrictions

Under the following conditions, [INVALID FUNCTION] is displayed and the settings cannot be configured.

Setting	Inoperable Condition or Mode
<b>HV DELAY</b>	<ul style="list-style-type: none"> <li>• SUB WINDOW</li> <li>• WFM</li> <li>• 3D ASSIST</li> <li>• When [INT-SG] is selected</li> <li>• In TWO WINDOW mode</li> <li>• PIXEL TO PIXEL</li> <li>• During PC signal input</li> </ul>
<b>BLUE ONLY</b>	In Y MAP ON mode
<b>GAMMA SELECT</b>	<ul style="list-style-type: none"> <li>• During GPI setting</li> <li>• During PC signal input</li> </ul>

(Continued on next page)

## Main Menu (continued)

Setting	Inoperable Condition or Mode
<b>SD ASPECT</b>	<ul style="list-style-type: none"> <li>• During GPI setting</li> <li>• 3D ASSIST</li> <li>• During PC signal input</li> <li>• During NO SIGNAL/UNSUPPORT SIGNAL input</li> <li>• When both signals are NO SIGNAL/UNSUPPORT SIGNAL in TWO WINDOW mode</li> <li>• SUB WINDOW (still image)</li> <li>• During HD signal input</li> </ul>
<b>SCAN</b>	<ul style="list-style-type: none"> <li>• During GPI setting</li> <li>• TWO WINDOW</li> <li>• 3D ASSIST</li> <li>• SUB WINDOW</li> <li>• PIXEL TO PIXEL</li> <li>• During PC signal input</li> </ul>
<b>SUB WINDOW</b>	<ul style="list-style-type: none"> <li>• 3D ASSIST</li> <li>• During NO SIGNAL/UNSUPPORT SIGNAL input and when something other than SUB WINDOW STILL is displayed</li> <li>• During PC signal input</li> <li>• When [INT-SG] is selected</li> </ul>
<b>WFM/VECTOR</b>	<p>(VECTOR is not displayed for inputs other than SDI1 or SDI2)</p> <ul style="list-style-type: none"> <li>• SUB WINDOW</li> <li>• During PICTURE ASSIST</li> <li>• 3D ASSIST</li> <li>• When [INT-SG] is selected</li> <li>• In TWO WINDOW mode</li> <li>• PIXEL TO PIXEL</li> <li>• During PC signal input</li> </ul>
<b>MARKER</b>	<ul style="list-style-type: none"> <li>• During GPI setting</li> <li>• In TWO WINDOW mode</li> <li>• PIXEL TO PIXEL</li> <li>• During PC signal input</li> <li>• SUB WINDOW</li> <li>• In PICTURE ASSIST mode</li> <li>• 3D ASSIST</li> </ul>
<b>WHITE BALANCE</b>	When other than VAR1 to VAR3 is selected in COLOR TEMP.
<b>PIXEL TO PIXEL</b>	<ul style="list-style-type: none"> <li>• For signals other than 720p signals</li> <li>• For signals other than HD signals during PICTURE ASSIST ON</li> <li>• During GPI setting</li> <li>• In SUB WINDOW mode</li> <li>• During PC signal input</li> <li>• 3D ASSIST</li> <li>• In TWO WINDOW mode</li> <li>• When [INT-SG] is selected</li> </ul>
<b>PIXEL POSITION</b>	<ul style="list-style-type: none"> <li>• During input other than HD signal input</li> <li>• For signals other than 720p signals during PICTURE ASSIST OFF</li> <li>• 3D ASSIST</li> </ul>
<b>FOCUS-IN-RED</b>	<ul style="list-style-type: none"> <li>• During GPI setting</li> <li>• When BLUE ONLY ON is selected</li> <li>• When 3D ASSIST ZOOM FUNCTION FOCUS is not on</li> <li>• During PC input</li> <li>• The TWO WINDOW function is on and both signals are NO SIGNAL/UNSUPPORT SIGNAL</li> <li>• When [INT-SG] is selected</li> <li>• Y MAP ON</li> <li>• NO SIGNAL</li> </ul>
<b>MONO</b>	<ul style="list-style-type: none"> <li>• During GPI setting</li> <li>• During PC signal input</li> <li>• Y MAP ON</li> </ul>
<b>TIME CODE</b>	When other than HD-SDI input
<b>CLOSED CAPTION</b>	<ul style="list-style-type: none"> <li>• 3D ASSIST</li> <li>• During PC signal input</li> </ul>
<b>BLACK MODE</b>	<ul style="list-style-type: none"> <li>• NO SIGNAL</li> <li>• Y MAP ON</li> <li>• The TWO WINDOW function is on and both signals are NO SIGNAL/UNSUPPORT SIGNAL</li> <li>• PICTURE ASSIST ON</li> </ul>
<b>AUDIO OUT SEL.</b>	<ul style="list-style-type: none"> <li>• During 3D ASSIST</li> <li>• When [AUDIO INPUT SEL] is not set to [AUTO] and the TWO WINDOW function is On</li> <li>• When the TWO WINDOW function is Off</li> </ul>
<b>ANAMO</b>	<ul style="list-style-type: none"> <li>• 3D ASSIST</li> <li>• In SUB WINDOW mode</li> <li>• PICTURE ASSIST mode</li> <li>• During PC signal input</li> <li>• In TWO WINDOW mode</li> </ul>
<b>TWO WINDOW</b>	During 3D ASSIST
<b>Y MAP</b>	<ul style="list-style-type: none"> <li>• During PC signal input</li> <li>• When 3D ASSIST ZOOM FOCUS is not on</li> <li>• When [INT-SG] is selected</li> </ul>
<b>PICTURE ASSIST</b>	<ul style="list-style-type: none"> <li>• During PC signal input</li> <li>• During 3D ASSIST</li> <li>• When [INT-SG] is selected</li> </ul>
<b>R COLOR</b>	<ul style="list-style-type: none"> <li>• When [BLUE ONLY ON] is selected</li> <li>• Y MAP ON</li> </ul>
<b>G COLOR</b>	<ul style="list-style-type: none"> <li>• When [BLUE ONLY ON] is selected</li> <li>• Y MAP ON</li> </ul>
<b>B COLOR</b>	<ul style="list-style-type: none"> <li>• When [BLUE ONLY ON] is selected</li> <li>• Y MAP ON</li> </ul>
<b>ZEBRA</b>	<ul style="list-style-type: none"> <li>• Y MAP ON</li> <li>• When [INT-SG] is selected</li> <li>• When 3D ASSIST ZOOM FOCUS is not on</li> <li>• When GPI is set</li> <li>• During PC signal input</li> </ul>
<b>ZEBRA LEVEL</b>	<ul style="list-style-type: none"> <li>• During PC signal input</li> </ul>



## Main Menu (continued)

### ■ Functions displayed during FUNCTION button operation

Pressing any of the <FUNCTION1> to <FUNCTION5> buttons displays the operations assigned to each button as shown below.

Setting	Display
<b>HV DELAY</b>	[DELAY OFF] → [H DELAY] → [V DELAY] → [HV DELAY]
<b>BLUE ONLY</b>	[BLUE ONLY OFF] → [BLUE ONLY ON]
<b>GAMMA SELECT</b>	[GAMMA STANDARD] → [GAMMA FILM] → [GAMMA STUDIO/PST] → [GAMMA CINEMA]
<b>SD ASPECT</b>	[4:3] → [16:9]
<b>SCAN</b>	[NORMAL SCAN] → [UNDER SCAN]
<b>SUB WINDOW</b>	[SINGLE] → [FULL/PART] → [STILL]
<b>WFM/VECTOR</b>	[WFM/VECTOR OFF] → [WFM Y ON] → [WFM R ON] → [WFM G ON] → [WFM B ON] → [VECTOR×1/×2S/×2/×4/×8]
<b>MARKER</b>	[MARKER OFF] → [4:3 MARKER/13:9MARKER/14:9MARKER/CNSCO2.39 MARKER/CNSCO2.35 MARKER/2:1 MARKER/ VISTA MARKER/95% MARKER/93% MARKER/90% MARKER/88% MARKER/80% MARKER/ xx% MARKER* <sup>10</sup> /xx%/yy% MARKER* <sup>11</sup> ] * <sup>10</sup> xx% indicates an 80 to 100% USER setting * <sup>11</sup> xx%/yy% is the VAR set value for 80 to 100 % aspect ratio • When the set values for both [16:9] and [4:3] are something other than [OFF] in the [MARKER] menu settings, the [16:9] set value is displayed in the first half, and the set value of [4:3] is displayed in the second half.
<b>WHITE BALANCE</b>	[WHITE BALANCE VAR 1/2/3]
<b>PIXEL TO PIXEL</b>	[PIXEL TO PIXEL OFF] → [PIXEL TO PIXEL LEFT/CENTER/RIGHT]
<b>PIXEL POSITION</b>	[PIXEL TO PIXEL LEFT] → [PIXEL TO PIXEL CENTER] → [PIXEL TO PIXEL RIGHT]
<b>FOCUS-IN-RED</b>	[FOCUS-IN-RED OFF] → [FOCUS-IN-RED ON]
<b>LEVEL METER</b>	[METER OFF] → [METER 2 CH/4 CH/8 CH]
<b>CROSS HATCH</b>	[CROSS HATCH OFF] → [CROSS HATCH LOW] → [CROSS HATCH HIGH]
<b>MONO</b>	[MONO OFF] → [MONO ON]
<b>BLACK MODE</b>	[BLACK MODE OFF] → [BLACK MODE ON]
<b>TIME CODE</b>	[TC OFF] → [LTC/VITC/LUB/VUB/LTC+LUB/VITC+VUB]
<b>CLOSED CAPTION</b>	The displayed items differ depending on the [CC TYPE] selection. When the [CC TYPE] setting is [CEA-608 (ANC)], [CEA-608 (VBI)] or [CEA-608 (708)]: [CC OFF] → [CC1/2/3/4] When the [CC TYPE] setting is [CEA-708]: [CC OFF] → [SRV1/2/3/4/5/6] When the [CC TYPE] setting is [OP-42]: [CC OFF] → [OP-42] When the [CC TYPE] setting is [OP-47]: [CC OFF] → [OP-47]
<b>AUDIO MUTE</b>	[AUDIO MUTE OFF] → [AUDIO MUTE ON]
<b>AUDIO OUT SEL.</b>	[SDI1] → [SDI2]
<b>ANAMO</b>	[ANAMO OFF] → [ANAMO ON]
<b>TWO WINDOW</b>	[SINGLE] → [TWO M/M]
<b>Y MAP</b>	[Y MAP OFF] → [Y MAP ON]
<b>PICTURE ASSIST</b>	[PICTURE ASSIST OFF] → [PICTURE ASSIST ON]
<b>R COLOR</b>	[R COLOR ON] → [R COLOR OFF]
<b>G COLOR</b>	[G COLOR ON] → [G COLOR OFF]
<b>B COLOR</b>	[B COLOR ON] → [B COLOR OFF]
<b>ZEBRA</b>	[ZEBRA OFF] → [ZEBRA INT.] → [ZEBRA EXT.] → [ZEBRA INT.+EXT.]
<b>ZEBRA LEVEL</b>	[SETTING]
<b>2D/3D ASSIST</b>	[2D] → [3D ASSIST]

#### <Note>

- [WHITE BALANCE] and [ZEBRA LEVEL] is switched to adjustment mode with a <FUNCTION> button, and operating status is not displayed.
- SUB WINDOW, TWO WINDOW, PICTURE ASSIST of the 2-screen display function are mutually exclusive functions - when one is on, the other two are off. For this reason, when one of the 2-screen display functions is on, the operating status of the function that is on is displayed when a screen is opened using the <FUNCTION> button.
- [CC1/2/3/4] and other [\*\*\*/\*\*] indications denote set values in relevant menus.

**FUNCTION skip function**

This function allows you to skip some of the functions assigned to FUNCTION during FUNCTION operation. When functions are assigned to <FUNCTION1> to <FUNCTION5> in the FUNCTION menu, a submenu that allows you to skip function settings appears. Turn [OFF] the setting you want to skip during FUNCTION operation.

Submenus appear for the following functions.

[HV DELAY], [GAMMA SELECT], [WFM/VECTOR], [PIXEL POSITION], [CROSS HATCH] and [ZEBRA]

<<Setup example>>

Select [WFM/VECTOR] in the [FUNCTION] menu and press the rotary knob <PICTURE> to open the submenu shown below.

1. Turn the rotary knob <PICTURE> to select the setting you want to skip and press the rotary knob <PICTURE>.

- The set value changes to green.

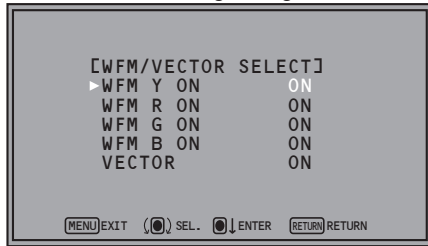

2. Turn the rotary knob <PICTURE> to select [OFF] and press the rotary knob <PICTURE>.

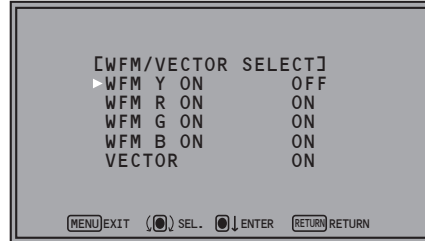

3. Press <RETURN/VOLUME>.

- The submenu closes and the [FUNCTION] menu reappears.

**HV DELAY**

This displays the blanking period. Each press of the button changes the display as follows: H blanking display → V blanking display → H and V blanking display → no blanking display.

**SUB WINDOW**

Use the SUB WINDOW function to split the screen (main window) in two as shown below to enable comparison of a recorded still image with live video.

Depending on the [SUB WINDOW] setting ([FULL], [PART]) in the [SYSTEM CONFIG] menu (→page 30) the screen display changes as shown below.

The screen switches at each press of a <FUNCTION1> to <FUNCTION5> (→page 12) button to which a SUB WINDOW function has been assigned.

- To use the SUB WINDOW function, it must be assigned to one of the <FUNCTION1> to <FUNCTION5> buttons.

To setup [I-P MODE] (→page 28), exit the SUB WINDOW function first.

**FULL**

Resizes the main window to also display a second window (two sub-windows).

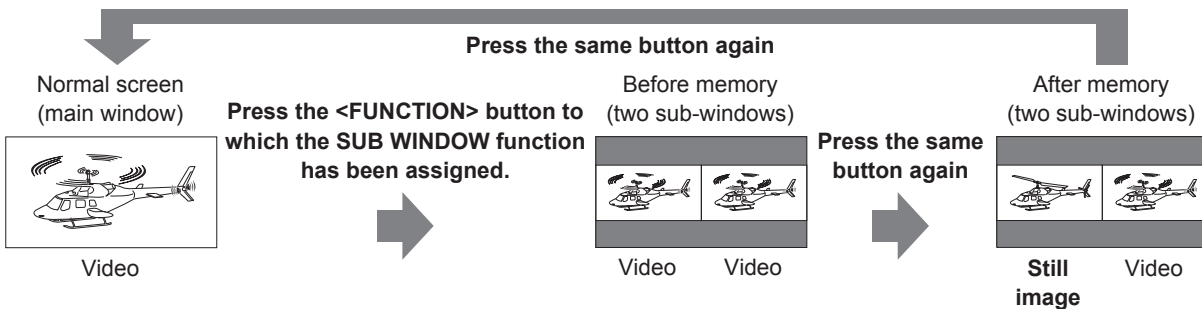

**PART**

Crops the main window to show only its center to also display a second image (two sub-windows).

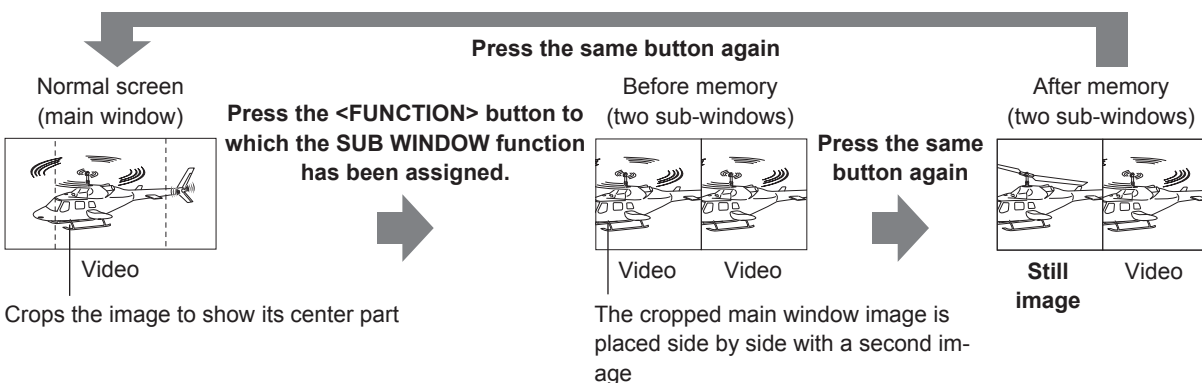

These examples show 16:9 aspect ratio images.

**Note on FULL/PART selection**

This function is designed to enable comparison of identical formats input to the same input terminal. Input of different formats via different input lines may distort the sub-window (left side, still image) or make part of the image disappear from view. However, input of an identical format signal to the input terminal during still image acquisition will display correctly.

**WFM/VECTOR**

The WFM/VECTOR function enables display of the waveform and vector display. Use [DISPLAY SETUP] in [MAIN MENU] (main menu) to select WFM and VECTOR display. (→page 46)  
 Press the <FUNCTION1> to <FUNCTION5> (→page 12) button to which the WFM/VECTOR function has been assigned to switch displays in the following order.

[WFM/VECTOR OFF] → [WFM Y ON] → [WFM R ON] → [WFM G ON] → [WFM B ON] → [VECTOR×1/×2S/×2/×4/×8]

• To use the WFM/VECTOR function, it must be assigned to one of the <FUNCTION1> to <FUNCTION5> buttons.

"WFM" signals are displayed in the following order: Y, R, G, B.

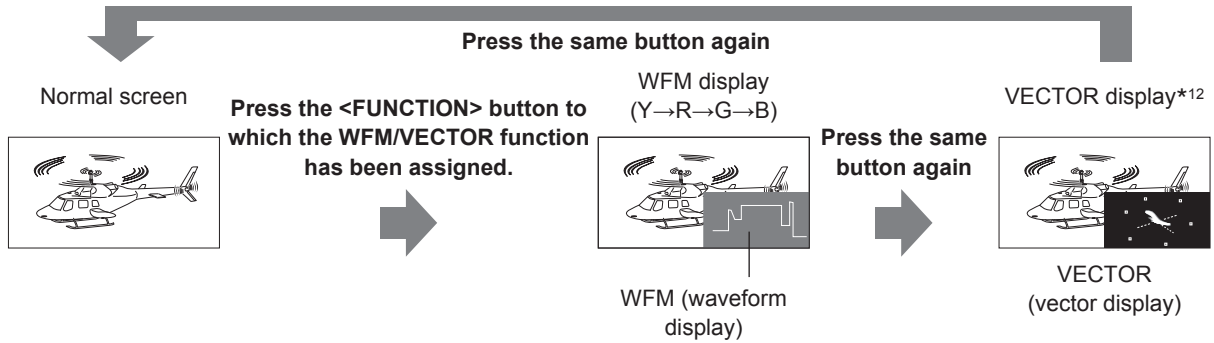

These examples show 16:9 aspect ratio images.

\*12Displayed only for SDI signal input.

• The scale display is as shown below.

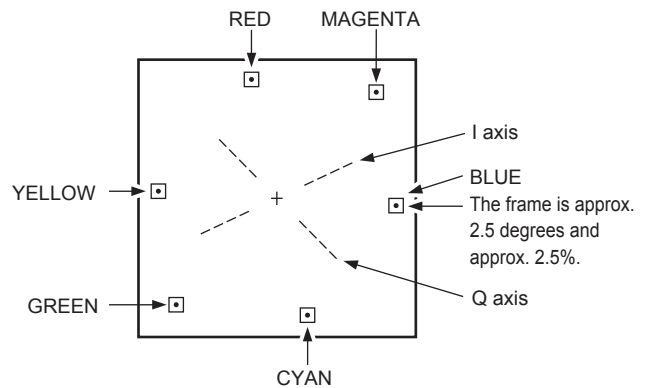
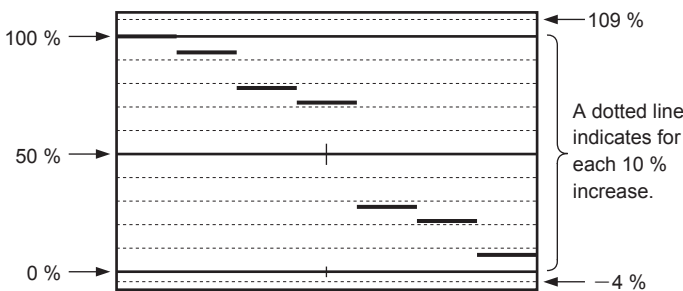

The vertical lines in the frame are color coded to simplify identification.

### ■ ZEBRA

The stripes of the ZEBRA function appear over an image (in the viewfinder) to help you adjust the aperture of a camera lens for optimum exposure and easily find the areas of an image that are overexposed and turn white (where clipping occurs). Press any of the <FUNCTION1> to <FUNCTION5> (→page 12) buttons to which [ZEBRA LEVEL] is assigned or select [ZEBRA] in the [VIDEO CONFIG] menu to set [INT.MIN.], [INT.MAX.], [EXT.MIN.] and [EXT.MAX.] levels. Press the <FUNCTION1> to <FUNCTION5> button to which the [ZEBRA] function has been assigned to turn the ZEBRA function on.

[INT.MIN.] and [INT.MAX.] show ZEBRA stripes for areas that are within menu set values.  
[EXT.MIN.] and [EXT.MAX.] show ZEBRA stripes for areas that are outside menu set values.

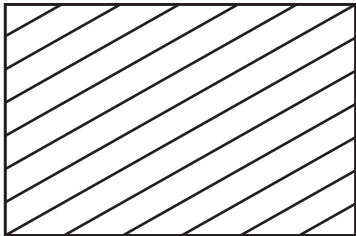

[INT.MIN.] and [INT.MAX.] ZEBRA pattern

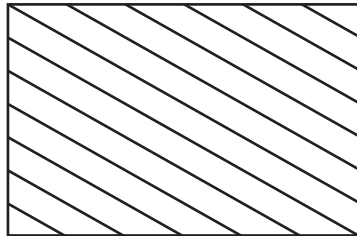

[EXT.MIN.] and [EXT.MAX.] ZEBRA pattern

### ■ Y MAP

The Y MAP function makes it easy to visually confirm overall screen brightness (luminance level map). Press the <FUNCTION1> to <FUNCTION5> (→page 12) button to which the [Y MAP] function has been assigned to turn it on. Turning on this function displays a simplified chart at the left side of the screen.

- Simplified chart details (The numbers in the simplified chart indicates Y signal levels.)

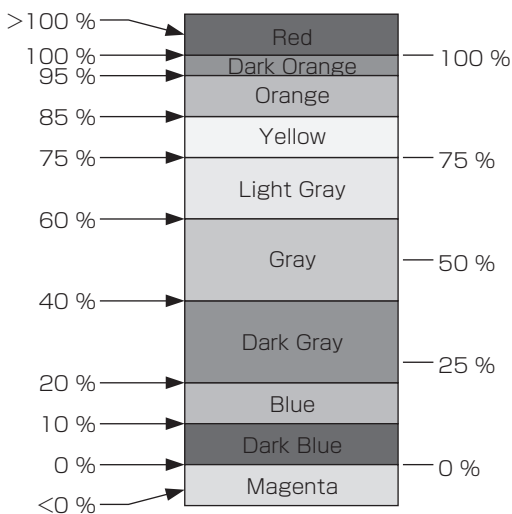

#### <Note>

- When [HALF] or [BLACK] is selected in [BACK] under the [MARKER] menu, the simplified chart indicates a signal level of 50 % or may not be displayed at all.
- When the Y MAP function is on, [BLACK MODE] is turned off.

■ TWO WINDOW

The TWO WINDOW function splits the screen into a left and a right window and displays the SDI1 and SDI2 inputs in separate windows (SDI1 in the left window and SDI2 in the right window).

The function also displays the audio volume and the in-monitor display (IMD) for both SDI1 and SDI2.

SDI1 and SDI2 are displayed at a fixed location.

The screen switches at each press of a <FUNCTION1> to <FUNCTION5> (→page 12) button to which [TWO WINDOW] has been assigned. (It is assigned to <FUNCTION2> in the factory defaults.)

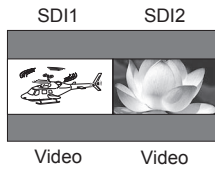

Press the <FUNCTION> button to which the TWO WINDOW function has been assigned.

<Note>

- When two screens are displayed, the left screen is the sync reference.
- When a signal is input only to one screen, that signal is the sync reference.
- When the frame frequency of the input signal formats of the two screens differ, frames may be skipped in the screen that is not synchronized to the sync reference.
- When the SDI1 or SDI2 signal enters [NO SIGNAL]/[UNSUPPORT SIGNAL] status, the screen will first blackout before displaying the screen that has a signal input.

■ PICTURE ASSIST

The PICTURE ASSIST functions display a signal selected from VIDEO, SDI1, SDI2, HDMI and DVI-I inputs on 2 screens.

These functions allow you to check the result of different effects in the left screen while comparing it to a single screen image in the right screen.

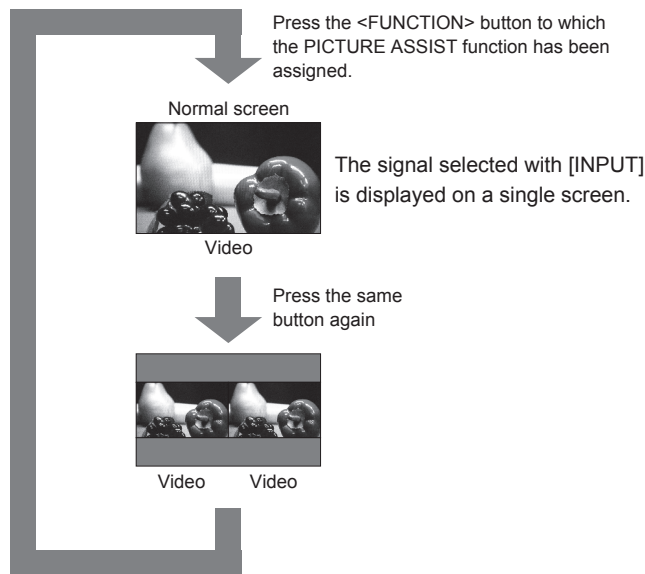

- List of functions  
 FOCUS-IN-RED  
 Y MAP  
 ZEBRA  
 SHARPNESS  
 PEAKING  
 PHASE  
 CHROMA  
 BRIGHT  
 CONTRAST  
 PIXEL TO PIXEL  
 HV DELAY

<Note>

- These functions are not available to PC input signals.
- A single screen image is always located in the right window.
- When the Y MAP function is turned on and a PICTURE ASSIST function is on and the [BLUE ONLY], [R COLOR], [G COLOR] or [B COLOR] function is on, [BLUE ONLY], [R COLOR], [G COLOR] or [B COLOR] effects cannot be applied to the right screen.
- When a PICTURE ASSIST function is on, BLACK MODE is turned off.
- When the PIXEL TO PIXEL function is on, the left screen goes to PIXEL TO PIXEL mode. The location of this effect can be changed using [PIXEL POSITION].

■ **PIXEL TO PIXEL and PIXEL POSITION**

The PIXEL TO PIXEL function allows you to check images at their actual pixel resolution. (HD signals only)

Press the <FUNCTION1> to <FUNCTION5> (→page 12) button to which the [PIXEL TO PIXEL] function has been assigned to turn the function on. Then press the <FUNCTION1> to <FUNCTION5> (→page 12) button to which the [PIXEL POSITION] function has been assigned to position the display of signals. Each press of the button will change the display position of the signal.

Underlined values indicate factory defaults.

Item	Setting	Description
<b>PIXEL TO PIXEL</b> *13*14	<u>OFF</u> ON	Sets whether to display the screen display size at the input signal size. [OFF] Not displayed      [ON] Displayed. Compatible formats • Only available in the left screen when a PICTURE ASSIST function is on 1080/60i, 1080/59.94i, 1080/50i, 1080/60p, 1080/59.94p, 1080/50p, 1080/30p, 1080/29.97p, 1080/25p, 1080/24p, 1080/23.98p, 1080/25PsF, 1080/24PsF, 1080/23.98PsF • Only available in the left screen and in 1-screen display when a PICTURE ASSIST function is on 720/60p, 720/59.94p, 720/50p
<b>PIXEL POSITION</b>	LEFT <u>CENTER</u> RIGHT	Positions the display of signals [PIXEL TO PIXEL] is [ON]. [LEFT]      Left of screen [CENTER]    Center of screen [RIGHT]     Right of screen • Normally, when the input signal is 720/60p, 720/59.94p or 720/50p in the single screen mode, the number of pixels of the monitor panel is greater than the number of samples of the input signal. Although the image can be set, it will be displayed at CENTER (screen center) and cannot be displayed at any other position.

\*13The following settings are disabled when [PIXEL TO PIXEL] is ON.

- Setting [ANAMO] to [ON], and setting [SCAN] to [UNDER] in [VIDEO CONFIG]
- Any [HV DELAY] setting in [FUNCTION]
- [MARKER] display

\*14Enabled during [SDI1], [SDI2], [HDMI], [YP<sub>B</sub>P<sub>R</sub>] and [DVI-VIDEO] input.

■ **PIXEL POSITION display position sequence**

PIXEL POSITION: ① → ② → ③ → .....

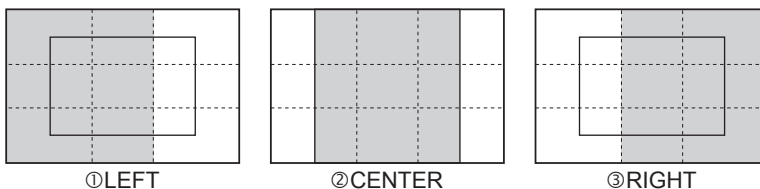

■ **CROSS HATCH**

The CROSS HATCH function displays markers at regular vertical and horizontal intervals to facilitate composition and other tasks. The marker line width is 1 dot per line and the interval is 120 dots/120 lines or 60 dots/60 lines depending on the [SIZE] setting in the [MARKER] menu (→page 24).

Each press of the <FUNCTION1> to <FUNCTION5> (→page 12) button to which the CROSS HATCH has been assigned changes the display.

Each press of the <FUNCTION> button to which the CROSS HATCH function is assigned changes the display as shown.  
HD/SD (16:9) mode

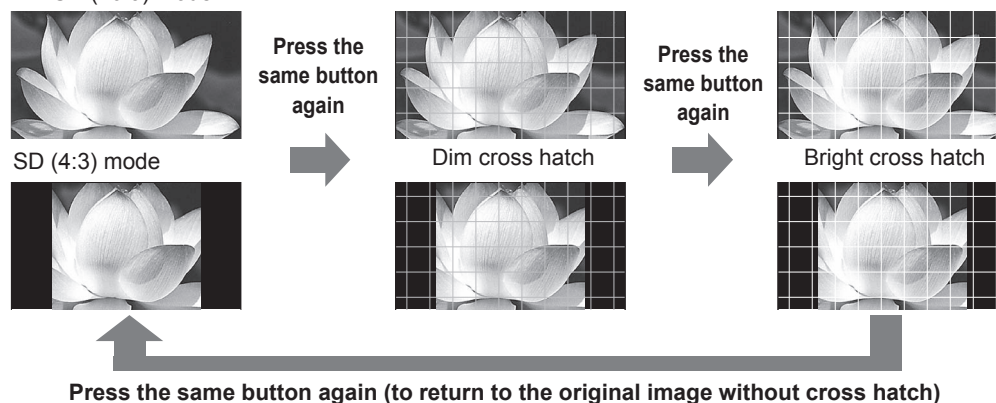

**■ FOCUS-IN-RED**

FOCUS-IN-RED shows the outline of a subject that is in focus in red to simplify focusing the camera. Each press of the <FUNCTION1> to <FUNCTION5> button to which the FOCUS-IN-RED has been assigned changes the display.

- To use the FOCUS-IN-RED function, it must be assigned to one of the <FUNCTION1> to <FUNCTION5> functions.

When the FOCUS-IN-RED function is displayed, use the rotary knob <PICTURE> to change detection sensitivity level (1 to 30). A higher numerical value results in higher detection sensitivity (outlines are displayed in red even when they are not properly focused). When you set [CHROMA] to [0] or assign [MONO] to another <FUNCTION> button to switch to monochrome, the focus will become easier to check.

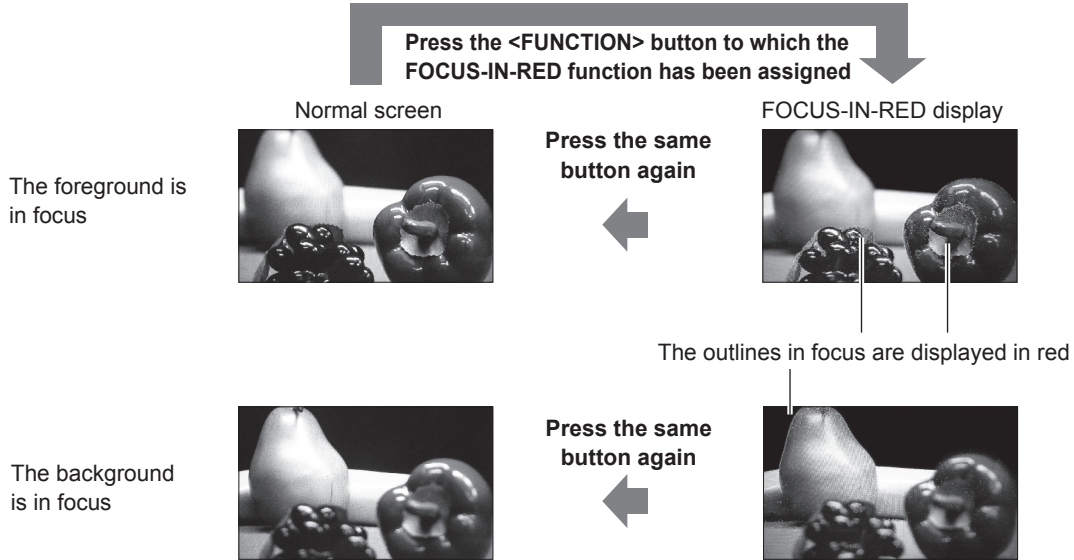

These examples show 16:9 aspect ratio images.

**<Note>**

- The red of the FOCUS-IN-RED function in the single and 2-screen display modes may differ slightly.

**GPI**

[GPI CONTROL] is used to enable and disable all GPI functions and assign functions to each of the GPI terminal (→page 60) pins.

Underlined values indicate factory defaults.

Submenu	Setting	Description
<b>GPI CONTROL</b>	<u>DISABLE</u> ENABLE	Enables and disables GPI functions [DISABLE] Disable [ENABLE] Enable
<b>GPI1 to GPI8</b>	<u>UNDEF</u> MARKER1 ON/OFF MARKER2 ON/OFF MARKER BACK HALF MARKER BACK BLACK CENTER MARKER CROSS MARKER INPUT SEL. VIDEO INPUT SEL. SD11 INPUT SEL. SD12 INPUT SEL. HDMI INPUT SEL. DVI-I INPUT SEL. INT-SG SD ASPECT SCAN R-TALLY G-TALLY MONO GAMMA SEL. FILM GAMMA SEL. STUDIO/PST GAMMA SEL. CINEMA PIXEL TO PIXEL FOCUS-IN-RED ZEBRA REMOTE STANDBY	Assigns functions to the GPI input terminal pins. The same item can be set to any of the terminals. (For details, refer to page 60)

**<Note>**

- Operation may not be possible depending on the setting conditions.  
Example: SD ASPECT operation when input signal is HD



## INPUT SELECT

Underlined values indicate factory defaults.

Submenu	Setting	Description
<b>VIDEO</b>	<u>AUTO</u> NTSC PAL	Used to select the format for VIDEO input.*1 [ <u>AUTO</u> ] Automatically selects NTSC or PAL. [NTSC] NTSC [PAL] PAL
<b>NTSC SETUP</b>	<u>00</u> 75	Selects NTSC setup level. [ <u>00</u> ] Select this when there is no setup signal. [75] Select this when using 7.5 % setup signals. (The monitor internally adjusts the 7.5 % setup level to suit the black level)
<b>DVI-I</b>	<u>DIGITAL</u> ANALOG	Selects DVI-I input mode. [ <u>DIGITAL</u> ] Selects digital input. [ANALOG] Selects analog input.
<b>DIGITAL</b>	<u>AUTO</u> VIDEO COMP.	Selects the DVI-I digital input mode. [ <u>AUTO</u> ] Selects the input mode automatically depending on the input format. [VIDEO] Selects component input. [COMP.] Selects PC input.
<b>ANALOG</b>	<u>YP<sub>B</sub>P<sub>R</sub></u> RGB-COMP.	Selects YP <sub>B</sub> P <sub>R</sub> (component) or RGB input mode when DVI-I is set to "ANALOG." [ <u>YP<sub>B</sub>P<sub>R</sub></u> ] Selects the YP <sub>B</sub> P <sub>R</sub> signal. [RGB-COMP.] Selects the PC RGB signal.
<b>COMPONENT LEVEL</b>	<u>SMPTE</u> B75 B00	Selects the YP <sub>B</sub> P <sub>R</sub> (component) signal input level of DVI-I analog inputs. [ <u>SMPTE</u> ] Signal level complies with SMPTE, and P <sub>B</sub> , P <sub>R</sub> are 0.7 V [p-p] at 100% chroma. [B75] Select this when connecting a Betacam or similar device with a setup function. (The monitor internally adjusts the 7.5 % setup level to suit the black level) [B00] Select this when connecting a Betacam or similar device without a setup function.
<b>RGB-COMP.</b>	▼	Performs analog PC settings. (→ Below "RGB-COMP.")

\*1 [AUTO] is the factory default, but select an appropriate format when there is risk that the input signal may be contaminated by outside noise.

#### ■ RGB-COMP.

Selecting [ANALOG.] under [DVI-I] in the [INPUT SELECT] menu and selecting [RGB-COMP.] under [ANALOG] opens the following menu.

Underlined values indicate factory defaults.

Submenu	Setting	Description
<b>H POSITION</b>	0 to 60 (Factory default setting: <u>30</u> )	Adjusts horizontal image display position in 2-clock units. *2
<b>V POSITION</b>	0 to 15 (Factory default setting: <u>8</u> )	Adjusts vertical image display position. *2
<b>PHASE</b>	0 to 31 (Factory default setting: <u>16</u> )	Adjusts the clock phase in 1/32 clock period increments. *2
<b>CLOCK</b>	700 to 2200 (Factory default setting* <sup>3</sup> )	Adjusts the sampling clock in 2-clock units. *2 *4
<b>RESET</b>		Returns [H POSITION], [V-POSITION], [PHASE] and [CLOCK] settings in the RGB-COMP. input compliant format to their factory defaults.

\*2 Each compatible input format can be adjusted, but not when user data is loaded (→page 30 "SETUP LOAD") or saved (→page 30 "SETUP SAVE").

\*3 [CLOCK] factory default values

Format	CLOCK	Format	CLOCK
640×480 (60 Hz)	800	1280×768 (60 Hz)	1664
800×600 (60 Hz)	1056	1280×1024 (60 Hz)	1688
1024×768 (60 Hz)	1344		

\*4 This menu is disabled when the input signal format is 1920 x 1080 (60 Hz).



## AUDIO

Sets the audio output (a speaker, headphones) and the audio volume bar meter.

Underlined values indicate factory defaults.

Submenu	Setting	Description
<b>INPUT SELECT</b>	<u>AUTO</u> ANALOG	Selects speaker, headphones output and audio volume bar meter display. [AUTO] <INPUT SELECT> button on the front panel (→page 12) When SDI input line is selected: Embedded audio (SDI terminal) <INPUT SELECT> button on the front panel (→page 12) When HDMI input line is selected: Embedded audio (HDMI terminal) When an input line other than SDI1, SDI2 or HDMI are selected with the <INPUT SELECT> button (→page 12) on the front panel: Analog (AUDIO input terminal) [ANALOG] Analog (AUDIO input terminal)
<b>GROUP SELECT</b>	<u>CH1 to CH8</u> CH9 to CH16	Group selection of 16-channel audio using SDI signals. [CH1 to CH8] Displays channel 1 to 8. [CH9 to CH16] Displays channel 9 to 16.
<b>SELECT L</b> *1 *2 *3 *4	CH1 to CH16 (Factory default: <u>CH1</u> )	Selects embedded audio channels to output to the speaker or headphones (L).
<b>SELECT R</b> *1 *4 *5 *6	CH1 to CH16 (Factory default: <u>CH2</u> )	Selects embedded audio channels to output to the speaker or headphones (R).
<b>SPEAKER OUT</b>	<u>MIX</u> L R	Selects SPEAKER OUT status. [MIX] Outputs a combination of audio selected with [SELECT L] and [SELECT R]. [L] Outputs the sound selected with [SELECT L]. [R] Outputs the sound selected with [SELECT R].
<b>LEVEL METER</b>	<u>OFF</u> ON	Selects whether or not to display the audio volume bar meter. (→page 18)
<b>CH SELECT</b> *7	2CH 4CH 8CH	Selects number of audio level meter channels. • 16 channels cannot be displayed simultaneously.
<b>POINT LINE</b>	OFF <u>ON</u>	Turns the 0 dB line (reference point) indication on the meter on and off.
<b>CH INFO.</b>	OFF <u>ON</u>	Switches the channel displayed on the meter on and off.
<b>HEAD ROOM</b> *8	12dB <u>18dB</u> *9 <u>20dB</u> *10	Sets the display position of the reference point in the meter display.

\*1 When [CH5] to [CH16] is selected during SDI SD signal input:

Switching is performed as follows:

[CH5]/[CH9]/[CH13]→[CH1], [CH6]/[CH10]/[CH14]→[CH2], [CH7]/[CH11]/[CH15]→[CH3], [CH8]/[CH12]/[CH16]→[CH4] (The menu settings remain as is.)

\*2 During HDMI signal input, CH1 audio is output regardless of the menu setting.

\*3 When analog audio is selected, L audio is output regardless of the menu setting.

\*4 A [SELECT L], [SELECT R] channel display setting is reflected directly after a [GROUP SELECT] change is confirmed.

\*5 During HDMI signal input, CH2 audio is output regardless of the menu setting.

\*6 When analog audio is selected, R audio is output regardless of the menu setting.

\*7 During HDMI signal or analog signal input, [2CH] is displayed regardless of the menu settings. During SD-SDI signal input, the display becomes [4CH] even if [8CH] is selected in the menu.

\*8 During analog signal input, the reference point is 20 dB regardless of menu setting.

\*9 Factory default setting for the BT-LH2170E.

\*10 Factory default setting for the BT-LH2170P.

## DISPLAY SETUP

Underlined values indicate factory defaults.

Submenu	Setting	Description
<b>WFM/VECTOR</b>	OFF WFM Y WFM R WFM G WFM B VECTOR	Switches between WFM/VECTOR waveform and vector display. [WFM Y] - [WFM B] Displays waveforms. [VECTOR] Displays vector waveforms.*1
<b>POSITION</b>	RT RB LB LT	Selects the position for the "WFM/VECTOR" waveform display.*1 [RT] Right Top [RB] Right Bottom [LB] Left Bottom [LT] Left Top
<b>VECTOR MODE</b>	<u>×1</u> ×2S ×2 ×4 ×8	Enlarges vector waveforms.*1 [×1] 1x [×2S] At 1x scale display only waveforms are enlarged to 2x. [×2] 2x [×4] 4x [×8] 8x
<b>VECTOR SCALE</b>	75% <u>100%</u>	Determines the scale of vector waveform. [75%] Displays it at 75 % scale. [100%] Displays it at 100 % scale.
<b>TIME CODE</b>	OFF ON	Selects whether to enable or disable time code display *2
<b>POSITION</b>	TOP RIGHT <u>CENTER</u> LEFT	Selects position of time code display.*2 [TOP] Top center of screen [RIGHT] Bottom right of screen [CENTER] Bottom center of screen [LEFT] Bottom left of screen
<b>FONT SIZE</b>	SMALL <u>LARGE</u>	Selects font size of time code display. [SMALL] Menu font size [LARGE] Twice the height and width of menu font size
<b>MODE SELECT</b>	LTC VITC LUB VUB LTC+LUB VITC+VUB	Selects time code display mode. [LTC] Displays linear time code. [VITC] Displays vertical interval time code. [LUB] Displays user bits included in LTC. [VUB] Displays user bits included in VITC. [LTC+LUB] Displays [LTC] and [LUB] on two consecutive lines. [VITC+VUB] Displays [VITC] and [VUB] on two consecutive lines.
<b>CLOSED CAPTION</b>	OFF ON	Selects whether to enable or disable closed caption display.*3
<b>CC TYPE</b>	CEA-608 (ANC) CEA-608 (VBI) CEA-608 (708) <u>CEA-708</u> OP-42 OP-47	Selects the closed caption display mode. [CEA-608 (ANC)] Displays data compliant with CEA-608 (ANC). [CEA-608 (VBI)] Displays data compliant with CEA-608 (VBI). [CEA-608 (708)] Displays CEA-608 standard data transmitted according to the CEA-708 standard. [CEA-708] Displays data compliant with CEA-708. [OP-42] Displays OP-42 data. [OP-47] Displays OP-47 data.
<b>CAPTION CHANNEL</b>	CC1 CC2 CC3 CC4	Selects the closed caption display channel for CEA-608.

\*1 Opens the vector display during SDI signal input.

\*2 When the TWO WINDOW function is operating, only SDI1 signals support time code display. As a result, the time code is displayed at the bottom left of the screen.

\*3 A bright line appears on line 21 when signal input is set to [ON] during video and underscan is enabled.

## Main Menu (continued)

Submenu	Setting	Description
<b>CAPTION SERVICE</b>	SRV1 SRV2 SRV3 SRV4 SRV5 SRV6	Selects the closed caption display service for [CEA-708].
<b>IN MONITOR DISPLAY</b>	OFF ON	Selects whether to enable or disable the IMD display.
<b>POSITION</b>	TOP BOTTOM	Selects the position for the IMD display. [TOP] Top of screen [BOTTOM] Bottom of screen
<b>CHAR. COLOR</b>	CMD WHITE BLUE GREEN YELLOW CYAN RED GRAY MAGENTA	Selects IMD font color. [CMD] Color specified by command*4 [WHITE] White [BLUE] Blue [GREEN] Green [YELLOW] Yellow [CYAN] Cyan [RED] Red [GRAY] Gray [MAGENTA] Magenta

\*4 When colors selected by commands are set to OFF, the IMD character string is not displayed.

**CONTROL**

Underlined values indicate factory defaults.

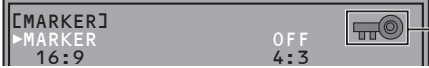
Submenu	Setting	Description
<b>CONTROL</b>	<u>LOCAL</u> REMOTE	<p>Selects operation. (with control lock)</p> <p>[LOCAL] Front panel operation is enabled (including controls that use the GPI function)</p> <p>[REMOTE] Remote operation enabled (controls using RS-232C or RS-485. Front panel operation is locked)</p> <ul style="list-style-type: none"> <li>• Power On/Off, VOLUME operations, GPI control and menu display are available when the lock is engaged.</li> <li>• Only [CONTROL]/[LOCAL ENABLE] menu items are available when the lock is engaged.</li> <li>• The rotary knob &lt;PICTURE&gt; cannot be used to change set values when the lock is engaged.</li> <li>• The [LOCAL ENABLE] setting determines operations in lock mode.</li> <li>• The  mark appears in the operation status display, menu display ([MAIN MENU] (main menu), [FUNCTION] menu, [INPUT SELECT] menu), [PICTURE] (picture adjusting) menu, and FUNCTION display screens when the lock is engaged.</li> </ul> 
<b>LOCAL ENABLE</b> *1	<u>DISABLE</u> INPUT FUNCTION INPUT+FUNC.	<p>Selects whether to enable or disable &lt;INPUT SELECT&gt; and &lt;FUNCTION&gt; button operations when [REMOTE] is selected under [CONTROL].</p> <p>[DISABLE] Disables &lt;INPUT SELECT&gt; and &lt;FUNCTION&gt; button operations.</p> <p>[INPUT] Enables &lt;INPUT SELECT&gt; button operations.</p> <p>[FUNCTION] Enables &lt;FUNCTION&gt; button operations.</p> <p>[INPUT+FUNC.] Enables &lt;INPUT SELECT&gt; and &lt;FUNCTION&gt; button operations.</p>
<b>PROTOCOL VER.</b> *2	<u>V3.1</u> V4.0	Selects version of the TSL protocol.
<b>RS-485 ID SETUP</b>	0 to 126 (Factory default setting: 0)	Sets the monitor ID number to use RS-485 communication.
<b>RS-485 STX&amp;ETX</b>	OFF <u>ON</u>	<p>Select RS-485 interface command format (→page 63).</p> <p>[OFF] STX and ETX need not be placed.</p> <p>[ON] STX and ETX must be placed.</p>

\*1 Only available when [REMOTE] is selected under [CONTROL].

\*2 The monitor supports version 3.1 and 4.0 of the TSL UMD PROTOCOL provided by Television System LTD.

**HOURS METER**

Submenu	Setting	Description
<b>OPERATION</b>	xxxxxxh *1	Displays the total number of hours it has been on.
<b>LCD</b>	xxxxxxh *1	Displays the number of hours that the backlight has been on.

\*1 "xxxxxx" indicates up to 262800 hours (about 30 years). [OVER] is indicated when the number of hours is 262800 or higher.

# 3D Assist Mode

The unit is equipped with a 3D assist mode to provide support for shooting with a rig-type 3D camera system. The 3D assist mode has the following functions.

## ■ Image input method: SIMULTANEOUS (simultaneous method)

Two types of image, one for the left eye (L) and one for the right eye (R), are input to the two SDI1 and SDI2 terminals.

- In 3D assist mode, the input is fixed to SDI1/SDI2 and the input line cannot be changed.
- A phase difference of up to  $\pm 15 \mu\text{s}$  between the SDI2 input signal and the SDI1 input signal, the reference, is appropriate.
- When the input signal formats of SDI1 and SDI2 are not identical or only one of the signals is input, the screen display will black out.

## ■ Assist functions

Assist Function Name	Screen Indication	Description
<b>MIRROR</b>	Side-by-side	Inverts the left and right and top and bottom of SDI1 (L) and SDI2 (R) images to enable you to make basic 3D camera adjustments. (Half-mirror type supported)
<b>SHIFT</b>	Overlay	Shifts SDI2 (R) image horizontally and vertically to enable the lens axis of the 3D camera to be checked.
<b>COMPARISON</b>	Side-by-side, top and bottom	Displays a halftone marker on the inside. A subject captured with only the camera of the L or R can be checked.
<b>CONVERGENCE</b>	Normal screen display	Switches the L/R images automatically or manually to enable the convergence point to be checked.
<b>COLOR</b>	Overlay	Overlays the L/R images on a checkerboard pattern to enable the brightness or color offset to be checked.
<b>ZOOM FOCUS</b>	Side-by-side	Enlarges part of an image to enable the focus offset or zoom offset to be checked.
<b>VERTICAL</b>	Side-by-side	Displays the horizontal line markers to enable the vertical offset to be checked.
<b>OVERLAY</b>	Overlay	Displays the vertical line markers to enable the width of parallax to be checked.

## ■ How to switch to 3D assist mode

Select [3D ASSIST] in [2D/3D ASSIST] in the [MAIN MENU] (main menu). The assist functions starts, and a status screen like the one shown in the figure on the rights appears.

- 1 Indicates the name of the assist function selected with the rotary knob <PICTURE>.
- 2 Indicates the format of the signal input to SDI1.
- 3 Indicates the format of the signal input to SDI2.
- 4 Opens the [3D ASSIST MENU] when the rotary knob <PICTURE> is pressed.
  - Select [3D ASSIST] to open the 3D assist menu.
  - Select [PICTURE] to open the [PICTURE] (picture adjusting) menu. (→page 21)

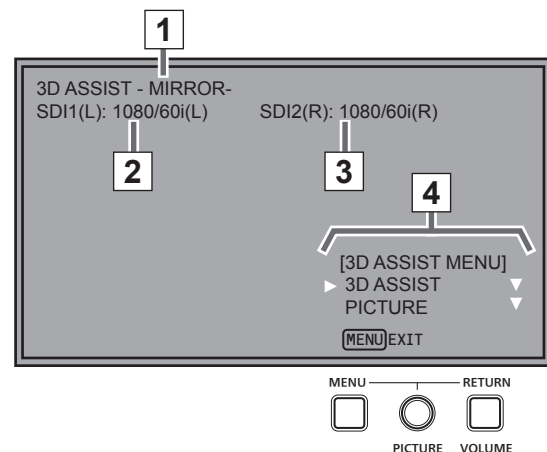

## <Note>

- When a signal on which the L/R information is superimposed is input to SDI1 such as when there is an AG-3DA1 or AG-3DP1 connection, the L/R information is displayed on the right side of the signal format. When L and R are incorrectly input, the LR information is displayed in yellow. When the L/R information is input to SDI2 only, the L/R information is not displayed on the right side of the signal format.

## ■ How to switch the assist function

Turn the rotary knob <PICTURE>. Each clockwise turn switches the assist function in the order as shown below.

[MIRROR]→[SHIFT]→[COMPARISON]→[CONVERGENCE]→[COLOR]→[ZOOM FOCUS]→[VERTICAL]→[OVERLAY]

### 3D Assist Mode (continued)

#### ■ How to return to 2D mode

Select [2D] in [2D/3D ASSIST] in [MAIN MENU] (main menu) or use the <FUNCTION> button or use [2D/3D ASSIST] in the [FUNCTION] menu to select it.

### MIRROR (Left/Right and Top/Bottom inversion)

This function performs left/right, top/bottom and left/right/top/bottom inversion of SDI1 (L) and SDI2 (R) images to enable basic adjustments of a rig-type 3D camera system (half mirror type).



#### Screen:

The L/R 2 screens are shown side-by-side.

#### <Note>

- Left and right inversion and top and bottom inversion are also reflected in other assist functions.
- The inversion setting information is even saved when the power is turned off.

Underlined values indicate factory defaults.

Menu	Setting	Description
SDI1 (L)	<u>OFF</u>	Inverts the left and right and top and bottom of images on the SDI1 (L) side.
	LR	[OFF] No inversion [LR] Left/right inversion
	TB	[TB] Top/bottom inversion [LRTB] Left/right/top/bottom inversion
	LRTB	
SDI2 (R)	<u>OFF</u>	Inverts the left and right and top and bottom of the images on the SDI2 (R) side.
	LR	[OFF] No inversion [LR] Left/right inversion
	TB	[TB] Top/bottom inversion [LRTB] Left/right/top/bottom inversion
	LRTB	

### SHIFT (Horizontal and Vertical Shift)

This function shifts the SDI2 (R) images horizontally or vertically to allow you to check the offset between the SDI2 (R) and SDI1 (L) images.

You can check the lens axis of a rig-type 3D camera system while checking the rotation offset of the image.



#### Screen:

Overlay L/R on one screen.

#### <Note>

The setting information for shifting images with the SHIFT function is not stored. The initial display state is restored when you switch to the COMPARISON function or another assist function.

Underlined values indicate factory defaults.

Menu	Setting	Description
H	-128 to 127 (Factory default setting: <u>0</u> )	Shifts the images on the SDI2 (R) side horizontally.
V	-32 to 31 (Factory default setting: <u>0</u> )	Shifts the images on the SDI2 (R) side vertically.

**COMPARISON (Composition Check)**

This function is for checking when the subject is captured with only the camera of one side.



**Screen:**

The L/R 2 screens are shown side-by-side or arranged vertically and a 70 % size half-tone marker is shown inside each of the images.

**<Assist Point>**

When there is only a left-eye or a right-eye image, discomfort will be felt in 3D mode and make stereoscopic vision difficult. Perform a comparison to check what part of the images are outside the markers.

Underlined values indicate factory defaults.

Menu	Setting	Description
COMPARISON	<u>SBYS</u>	[SBYS] The SDI1 (L) image appears on the left side and the SDI2 (R) image appears on the right side.
	T&B	[T&B] The SDI1 (L) image appears at the top and the SDI2 (R) image appears at the bottom.

**CONVERGENCE (Convergence Check)**

This function is for checking the subject's position at a fixed screen position in order to determine the depth position of the main subject.

Automatically or manually switch the SDI1 (L) image and SDI2 (R) image and then check the subject's position.



**Screen:**

Normal display of one screen

**<Assist Point>**

- The place at which the image does not change is the convergence point.
- When the camera adjustment (vertical or rotation direction position adjustment) is correct, the image at other than the convergence point will shift to the left/right target.

Underlined values indicate factory defaults.

Menu	Setting	Description
CONVERGENCE	<u>MANUAL</u>	Selects how the images on SDI1 (L) side and the SDI2 (R) side are switched.
	AUTO	[MANUAL] Manual switching [AUTO] Automatic switching
MANUAL	<u>L</u>	Selects the image to display when [CONVERGENCE] is set to [MANUAL].
	R	[L] SDI1 (L) side image [R] SDI2 (R) side image
SPEED	<u>SLOW</u>	Selects the speed when [CONVERGENCE] is set to [AUTO].
	FAST	[SLOW] Every 1 second [FAST] Every 4 frames (at 720P: Every 8 frames)



### 3D Assist Mode (continued)

#### COLOR (Color Check)

This function overlays and displays the SDI1 (L) image and SDI2 (R) image on a checkerboard pattern in one screen to enable you to check the brightness offset and color differences



**Screen:**

Overlay L/R on one screen.

**<Assist Point>**

When it is easy to see the borderline of the checkerboard pattern, the brightness or color of L/R images is offset.

Underlined values indicate factory defaults.

Menu	Setting	Description
<b>SIZE</b>	128	Selects the checkerboard grid size when overlaying the SDI1 (L) side and SDI2 (R) side images. [128] The checkerboard grid consists of squares of 128 samples and 128 lines. [256] The checkerboard grid consists of squares of 256 samples and 256 lines.
	<u>256</u>	

#### ZOOM FOCUS (Zoom and Focus Check)

This function enlarges part of an image to enable you to check left and right focus offset and zoom offset.



**Screen:**

The L/R 2 screens are shown side-by-side.

**<Assist Point>**

Expanding the parts that are not in focus makes it easy to check the focus of the left and right cameras.

Underlined values indicate factory defaults.

Menu	Setting	Description
<b>ZOOM</b>	<u>OFF</u>	Selects image enlargement and the signal display position of the enlarged image (PIXEL TO PIXEL). [OFF] Displays two screens side-by-side [C] Center of screen [L] Left of screen [R] Right of screen
	C	
	L	
	R	
<b>F-IN-R</b>	<u>OFF</u>	Turns OFF/ON the FOCUS-IN-RED function in the displayed screen. [OFF] Turns the function off. [ON] Turns the function on
	ON	
<b>LEVEL</b>	1 to 30	Adjusts the detection sensitivity of FOCUS-IN-RED. (The numerical value turns green when sensitivity adjustment can be made.) A higher numerical value results in lower detection sensitivity (lack of sharpness). [1] to [30] Common left and right detection level
	(Factory default setting: <u>15</u> )	



## 3D Assist Mode (continued)

### VERTICAL (Vertical Offset Check)

This function enables you to operate two horizontal line markers to check the number of lines between markers in the displayed image and check vertical offset.



- The number of lines of the displayed image is measured and then the number of lines between the two horizontal line markers is displayed at the bottom right of the screen.

#### Screen:

The L/R 2 screens are shown side-by-side, and two markers are shown.

#### <Assist Point>

- Displaying horizontal line markers makes it easy to check the left/right vertical offset.
- When the vertical offset becomes large, discomfort will be felt and stereoscopic vision will become difficult when the mode is set to 3D so make adjustments trying your hardest to eliminate camera vertical offset.

Underlined values indicate factory defaults.

Menu	Setting	Description
<b>MARKER1</b>	0 to 1078 (Factory default setting: <u>540</u> )	Shifts the upper horizontal line marker up or down.*1
<b>MARKER2</b>	0 to 1078 (Factory default setting: <u>540</u> )	Shifts the lower horizontal line marker up or down.*1

\*1 The two horizontal line markers are each indicated by two lines, and the position of the upper line is indicated.

### OVERLAY (Parallax Check)

This function displays vertical line markers to enable you to check the width of parallax.

Overlay display



Gray display



#### Screen:

L/R images are overlaid and shown on one screen, and vertical line markers are shown at 1 %, 2 % and 3 % intervals across the horizontal image width.

- Vertical line markers can also be displayed in a gray screen in which the parallax portion is emphasized (gray display).

#### <Assist Point>

When the parallax is way too large, stereoscopic vision will become difficult when 3D images are viewed so check the width of parallax of the L side and R side images, using the width of the vertical line markers as a reference.

### 3D Assist Mode (continued)

Underlined values indicate factory defaults.

Menu	Setting	Description
<b>OVERLAY</b>	<u>STANDARD</u> GLAY COLOR	Selects overlay or gray display (displays image differences that emphasize the parallax portion). [STANDARD] Overlay display [GLAY] Gray display (differences display) [COLOR] Color indicated (differences display) Edge of SDI1 (L) side image Red Edge of SDI2 (R) side image Green • When [COLOR] is selected, [L: RED R: GREEN] is displayed in the menu.
<b>MKR POSI</b>	0 to 56 (MKR WIDTH 3% setting) 0 to 37 (MKR WIDTH 2% setting) 0 to 18 (MKR WIDTH 1% setting) (Factory default setting: <u>0</u> )	Shifts the vertical line marker in the horizontal direction.
<b>MKR WIDTH</b>	<u>3%</u> 2% 1%	Selects the interval of a vertical line marker. [3%] Shown at 3 % intervals across the horizontal image width [2%] Shown at 2 % intervals across the horizontal image width [1%] Shown at 1 % intervals across the horizontal image width • Changing [MKR WIDTH] automatically changes the [MKR POSI] setting that is tied to it.

# Setting Item Restrictions

## ■ List of Setting Item Restrictions in 2D Mode

(✓: Can be set)

Setting item		Input terminal		VIDEO			SDI1/SDI2			HDMI			DVI-I					
													ANALOG			DIGITAL		
		RGB-COMP.			YPbPr			COMP.		VIDEO								
		—	SD	HD	COMP.	SD	HD	—	SD	HD	—	SD	HD					
2D/3D ASSIST		✓	✓	✓	✓	✓	✓	✓	✓	✓	✓	✓	✓	✓	✓	✓		
MARKER	MARKER *1*2	✓	✓	✓	✓*3	✓	✓	✓*3	✓	✓	✓*3	✓	✓	✓*3	✓	✓		
	16:9 *1*2	✓	✓	✓	✓*3	✓	✓	✓*3	✓	✓	✓*3	✓	✓	✓*3	✓	✓		
	4:3 *1*2	✓	✓	✓	✓*3	✓	✓	✓*3	✓	✓	✓*3	✓	✓	✓*3	✓	✓		
	BACK *1*2	✓	✓	✓	✓*3	✓	✓	✓*3	✓	✓	✓*3	✓	✓	✓*3	✓	✓		
	CENTER *1*2	✓	✓	✓	✓*3	✓	✓	✓*3	✓	✓	✓*3	✓	✓	✓*3	✓	✓		
	CROSS *1*2	✓	✓	✓	✓*3	✓	✓	✓*3	✓	✓	✓*3	✓	✓	✓*3	✓	✓		
	COLOR *1*2	✓	✓	✓	✓*3	✓	✓	✓*3	✓	✓	✓*3	✓	✓	✓*3	✓	✓		
	GPI MARKER1	✓	✓	✓	✓*3	✓	✓	✓*3	✓	✓	✓*3	✓	✓	✓*3	✓	✓		
	GPI MARKER2	✓	✓	✓	✓*3	✓	✓	✓*3	✓	✓	✓*3	✓	✓	✓*3	✓	✓		
	MARKER TYPE *1*2	✓	✓	✓	✓*3	✓	✓	✓*3	✓	✓	✓*3	✓	✓	✓*3	✓	✓		
	CROSS HATCH	✓	✓	✓	✓	✓	✓	✓	✓	✓	✓	✓	✓	✓	✓	✓		
SIZE	✓	✓	✓	✓	✓	✓	✓	✓	✓	✓	✓	✓	✓	✓	✓			
VIDEO CONFIG	GAMMA SELECT	✓	✓	✓		✓	✓		✓	✓		✓	✓		✓	✓		
	FILM GAMMA	✓	✓	✓		✓	✓		✓	✓		✓	✓		✓	✓		
	COLOR TEMP.	✓	✓	✓	✓	✓	✓	✓	✓	✓	✓	✓	✓	✓	✓	✓		
	SHARPNESS MODE	✓	✓	✓		✓	✓		✓	✓		✓	✓		✓	✓		
	SHARPNESS H	✓	✓	✓		✓	✓		✓	✓		✓	✓		✓	✓		
	SHARPNESS V	✓	✓	✓		✓	✓		✓	✓		✓	✓		✓	✓		
	I-P MODE	✓	✓	✓		✓	✓		✓	✓		✓	✓		✓	✓		
	MONO	✓	✓	✓		✓	✓		✓	✓		✓	✓		✓	✓		
	ANAMO *1*2	✓*3	✓*3	✓		✓*3	✓*3		✓*3	✓*3		✓*3	✓*3		✓*3	✓*3		
	SD ASPECT *1*2*4	✓	✓	✓*3		✓	✓*3		✓	✓*3		✓	✓*3		✓	✓*3		
	SCAN *1*2	✓	✓	✓		✓	✓		✓	✓		✓	✓		✓	✓		
	ZEBRA INT MIN.	✓	✓	✓		✓	✓		✓	✓		✓	✓		✓	✓		
	INT MAX.	✓	✓	✓		✓	✓		✓	✓		✓	✓		✓	✓		
	EXT MIN.	✓	✓	✓		✓	✓		✓	✓		✓	✓		✓	✓		
EXT MAX.	✓	✓	✓		✓	✓		✓	✓		✓	✓		✓	✓			

\*1 Settings are disabled when the 2-screen display function is on.

\*2 Settings are disabled when the PIXEL TO PIXEL mode is on.

\*3 Settings can be made, but the function is disabled.

\*4 This setting is not available when a still image is shown in a split-screen.

(Continued on next page)

## Setting Item Restrictions (continued)

(✓: Can be set)

Setting item		Input terminal			HDMI			DVI-I					
		VIDEO	SDI1/SDI2		COMP.	SD	HD	ANALOG			DIGITAL		
			—	SD				HD	RGB-COMP.	Y <sub>P</sub> B <sub>P</sub> R	COMP.	VIDEO	
		—	SD	HD	COMP.	SD	HD	—	SD	HD	—	SD	HD
SYSTEM CONFIG	SUB WINDOW	✓	✓	✓		✓	✓		✓	✓		✓	✓
	MENU POSITION	✓	✓	✓	✓	✓	✓	✓	✓	✓	✓	✓	✓
	STATUS DISPLAY	✓	✓	✓	✓	✓	✓	✓	✓	✓	✓	✓	✓
	INPUT NAME SETUP	✓	✓	✓	✓	✓	✓	✓	✓	✓	✓	✓	✓
	SETUP LOAD	✓	✓	✓	✓	✓	✓	✓	✓	✓	✓	✓	✓
	SETUP SAVE	✓	✓	✓	✓	✓	✓	✓	✓	✓	✓	✓	✓
	POWER ON SETUP	✓	✓	✓	✓	✓	✓	✓	✓	✓	✓	✓	✓
	COLOR SPACE	✓	✓	✓	✓	✓	✓	✓	✓	✓	✓	✓	✓
	POWER DOWN	✓	✓	✓	✓	✓	✓	✓	✓	✓	✓	✓	✓
	POWER SAVE MODE	✓	✓	✓	✓	✓	✓	✓	✓	✓	✓	✓	✓
CALIBRATION	✓	✓	✓	✓	✓	✓	✓	✓	✓	✓	✓	✓	
FUNCTION	FUNCTION1-5	✓	✓	✓	✓	✓	✓	✓	✓	✓	✓	✓	✓
	FUNCTION DISPLAY	✓	✓	✓	✓	✓	✓	✓	✓	✓	✓	✓	✓
GPI	GPI CONTROL	✓	✓	✓	✓	✓	✓	✓	✓	✓	✓	✓	✓
	GPI1 to GPI8	✓	✓	✓	✓	✓	✓	✓	✓	✓	✓	✓	✓
INPUT SELECT	VIDEO	✓	✓*3	✓*3	✓*3	✓*3	✓*3	✓*3	✓*3	✓*3	✓*3	✓*3	✓*3
	NTSC SETUP	✓	✓*3	✓*3	✓*3	✓*3	✓*3	✓*3	✓*3	✓*3	✓*3	✓*3	✓*3
	DVI-I	✓*3	✓*3	✓*3	✓*3	✓*3	✓*3	✓	✓	✓	✓	✓	✓
	DIGITAL	✓*3	✓*3	✓*3	✓*3	✓*3	✓*3	✓*3	✓*3	✓*3	✓	✓	✓
	ANALOG	✓*3	✓*3	✓*3	✓*3	✓*3	✓*3	✓	✓	✓	✓*3	✓*3	✓*3
	COMPONENT LEVEL	✓*3	✓*3	✓*3	✓*3	✓*3	✓*3	✓*3	✓	✓*3	✓*3	✓*3	✓*3
	RGB-COMP.							✓					
AUDIO	INPUT SELECT	✓	✓	✓	✓	✓	✓	✓	✓	✓	✓	✓	✓
	GROUP SELECT	✓*3	✓	✓	✓*3	✓*3	✓*3	✓*3	✓*3	✓*3	✓*3	✓*3	✓*3
	SELECT L	✓*3	✓	✓	✓	✓	✓	✓*3	✓*3	✓*3	✓*3	✓*3	✓*3
	SELECT R	✓*3	✓	✓	✓	✓	✓	✓*3	✓*3	✓*3	✓*3	✓*3	✓*3
	SPEAKER OUT	✓	✓	✓	✓	✓	✓	✓	✓	✓	✓	✓	✓
	LEVEL METER	✓	✓	✓	✓	✓	✓	✓	✓	✓	✓	✓	✓
	CH SELECT	✓*3	✓	✓	✓	✓*3	✓*3	✓*3	✓*3	✓*3	✓*3	✓*3	✓*3
	POINT LINE	✓	✓	✓	✓	✓	✓	✓	✓	✓	✓	✓	✓
	CH INFO.	✓	✓	✓	✓	✓	✓	✓	✓	✓	✓	✓	✓
HEAD ROOM	✓	✓	✓	✓	✓	✓	✓	✓	✓	✓	✓	✓	

\*3 Settings can be made, but the function is disabled.

## Setting Item Restrictions (continued)

(✓: Can be set)

Setting item		Input terminal			DVI-I											
					VIDEO			SDI1/SDI2			HDMI			ANALOG		
		—			SD			HD			RGB-COMP.	YPbPr		COMP.	VIDEO	
		—	SD	HD	COMP.	SD	HD	—	SD	HD	—	SD	HD			
DISPLAY SETUP	WFM/VECTOR *1*2	✓*4	✓	✓		✓*4	✓*4		✓*4	✓*4		✓*4	✓*4			
	POSITION *1*2	✓	✓	✓		✓	✓		✓	✓		✓	✓			
	VECTOR MODE *1*2	✓*3	✓	✓		✓*3	✓*3		✓*3	✓*3		✓*3	✓*3			
	VECTOR SCALE *1*2	✓*3	✓	✓		✓*3	✓*3		✓*3	✓*3		✓*3	✓*3			
	TIME CODE	✓*3	✓*3	✓	✓*3	✓*3	✓*3	✓*3	✓*3	✓*3	✓*3	✓*3	✓*3			
	POSITION	✓*3	✓*3	✓	✓*3	✓*3	✓*3	✓*3	✓*3	✓*3	✓*3	✓*3	✓*3			
	FONT SIZE	✓*3	✓*3	✓	✓*3	✓*3	✓*3	✓*3	✓*3	✓*3	✓*3	✓*3	✓*3			
	MODE SELECT	✓*3	✓*3	✓	✓*3	✓*3	✓*3	✓*3	✓*3	✓*3	✓*3	✓*3	✓*3			
	CLOSED CAPTION	✓	✓	✓	✓*3	✓*3	✓*3	✓*3	✓*3	✓*3	✓*3	✓*3	✓*3			
	CC TYPE	✓*3	✓	✓	✓*3	✓*3	✓*3	✓*3	✓*3	✓*3	✓*3	✓*3	✓*3			
	CAPTION CHANNEL	✓	✓	✓	✓*3	✓*3	✓*3	✓*3	✓*3	✓*3	✓*3	✓*3	✓*3			
	CAPTION SERVICE	✓*3	✓*3	✓	✓*3	✓*3	✓*3	✓*3	✓*3	✓*3	✓*3	✓*3	✓*3			
	IN MONITOR DISPLAY	✓	✓	✓	✓	✓	✓	✓	✓	✓	✓	✓	✓			
	POSITION	✓	✓	✓	✓	✓	✓	✓	✓	✓	✓	✓	✓			
CHAR. COLOR	✓	✓	✓	✓	✓	✓	✓	✓	✓	✓	✓	✓				
CONTROL	CONTROL	✓	✓	✓	✓	✓	✓	✓	✓	✓	✓	✓				
	LOCAL ENABLE	✓	✓	✓	✓	✓	✓	✓	✓	✓	✓	✓				
	PROTOCOL VER.	✓	✓	✓	✓	✓	✓	✓	✓	✓	✓	✓				
	RS-485 ID SETUP	✓	✓	✓	✓	✓	✓	✓	✓	✓	✓	✓				
	RS-485 STX&ETX	✓	✓	✓	✓	✓	✓	✓	✓	✓	✓	✓				
HOURS METER	OPERATION	✓	✓	✓	✓	✓	✓	✓	✓	✓	✓	✓				
	LCD	✓	✓	✓	✓	✓	✓	✓	✓	✓	✓	✓				

\*1 Settings are disabled when the 2-screen display function is on.

\*2 Settings are disabled when the PIXEL TO PIXEL mode is on.

\*3 Settings can be made, but the function is disabled.

\*4 VECTOR display is only shown when there is SDI input.

## Setting Item Restrictions (continued)

### ■ List of Setting Item Restrictions in 3D Assist Mode

(✓: Can be set)

Setting item	Input terminal	SDI1/SDI2	
		HD	
2D/3D ASSIST		✓	
MARKER	MARKER		
	16:9		
	4:3		
	BACK		
	CENTER		
	CROSS		
	COLOR		
	GPI MARKER1		
	GPI MARKER2		
	MARKER TYPE		
	CROSS HATCH	✓	
	SIZE	✓	
	VIDEO CONFIG	GAMMA SELECT	✓
		FILM GAMMA	✓
COLOR TEMP.		✓	
SHARPNESS MODE		✓	
SHARPNESS H		✓	
SHARPNESS V		✓	
I-P MODE		✓	
MONO		✓	
ANAMO			
SD ASPECT			
SCAN			
ZEBRA INT MIN.		✓	
INT MAX.		✓	
EXT MIN.		✓	
EXT MAX.	✓		
SYSTEM CONFIG	SUB WINDOW		
	MENU POSITION	✓	
	STATUS DISPLAY	✓	
	INPUT NAME SETUP	✓	
	SETUP LOAD	✓	
	SETUP SAVE	✓	
	POWER ON SETUP	✓	
	COLOR SPACE	✓	
	POWER DOWN	✓	
	POWER SAVE MODE	✓	
	CALIBRATION	✓	

Setting item	Input terminal	SDI1/SDI2	
		HD	
FUNCTION	FUNCTION1	✓	
	FUNCTION2	✓	
	FUNCTION3	✓	
	FUNCTION4	✓	
	FUNCTION5	✓	
	FUNCTION DISPLAY	✓	
GPI	GPI CONTROL	✓	
	GPI1 to GPI8	✓	
INPUT SELECT	VIDEO		
	NTSC SETUP		
	DVI-I		
	DIGITAL		
	ANALOG		
	COMPONENT LEVEL		
AUDIO	RGB-COMP.		
	INPUT SELECT	✓	
	GROUP SELECT	✓	
	SELECT L	✓	
	SELECT R	✓	
	SPEAKER OUT	✓	
	LEVEL METER	✓	
	CH SELECT	✓	
	POINT LINE	✓	
	CH INFO.	✓	
	HEAD ROOM	✓	
	DISPLAY SETUP	WFM/VECTOR	
		POSITION	
VECTOR MODE			
VECTOR SCALE			
TIME CODE		✓	
POSITION		✓	
FONT SIZE		✓	
MODE SELECT		✓	
CLOSED CAPTION			
CC TYPE			
CAPTION CHANNEL			
CAPTION SERVICE			
IN MONITOR DISPLAY		✓	
POSITION	✓		
CHAR. COLOR	✓		

## Setting Item Restrictions (continued)

---

(✓: Can be set)

Setting item	Input terminal	SDI1/SDI2
		HD
CONTROL	CONTROL	✓
	LOCAL ENABLE	✓
	PROTOCOL VER.	✓
	RS-485 ID SETUP	✓
	RS-485 STX&ETX	✓
HOURS METER	OPERATION	✓
	LCD	✓

# REMOTE Specifications

This monitor enables remote operation via the GPI input terminal, the RS-232C input terminal or the RS-485 input/output terminal.

## GPI input terminal

GPI screen items correspond to the following terminals. Use the GPI menu to assign functions to each terminal. (→page 43) The functions assigned to each terminal are executed as specified depending on whether GND (pin 5) is short-circuited (ON) or open (OFF).

### ■ Operating conditions

Level operation: Operates when GND is short-circuited.

Edge operation: Operates when GND changes from open to short-circuited.

#### <Note>

- When level operation is assigned to more than one terminal, the function operates as long as one of the terminals is short-circuited.
- Hold the edge operation for at least 0.2 seconds after the change.

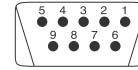

GPI input terminal  
(9 pins)

Pin number	Signal
1	GPI1
2	GPI2
3	GPI3
4	GPI4
5	GND
6	GPI5
7	GPI6
8	GPI7
9	GPI8

Assigned item	Function	Operating conditions
<b>UNDEF</b>	Undefined (no function assigned)	—
<b>MARKER1 ON/OFF</b> *1	Switches marker display defined in [GPI MARKER1] (→page 25) in the [MARKER] menu.	Level operation (Short-circuited: ON, Open: OFF)
<b>MARKER2 ON/OFF</b> *1	Switches marker display defined in [GPI MARKER2] (→page 25) in the [MARKER] menu.	Level operation (Short-circuited: ON, Open: OFF)
<b>MARKER BACK HALF</b> *2	Reduces the brightness of the background outside the marker displayed in [GPI MARKER1] (→page 25) to 50 %.	Level operation (Short-circuited: ON, Open: OFF)
<b>MARKER BACK BLACK</b> *2	Reduces the brightness of the background outside the marker displayed in [GPI MARKER1] (→page 25) to 0 %.	Level operation (Short-circuited: ON, Open: OFF)
<b>CENTER MARKER</b>	Turns the center marker display on and off. (When other markers are displayed, this marker is superimposed on other markers.)	Level operation (Short-circuited: ON, Open: OFF)
<b>CROSS MARKER</b>	Turns the cross marker display on and off. (When other markers are displayed, this marker is superimposed on other markers.)	Level operation (Short-circuited: ON, Open: OFF)
<b>INPUT SEL. VIDEO</b>	Switches the input line to VIDEO.	Edge operation
<b>INPUT SEL. SDI1</b>	Switches the input line to SDI1.	Edge operation
<b>INPUT SEL. SDI2</b>	Switches the input line to SDI2.	Edge operation
<b>INPUT SEL. HDMI</b>	Switches the input line to HDMI.	Edge operation
<b>INPUT SEL. DVI-I</b>	Switches the input line to DVI-I.	Edge operation
<b>INPUT SEL. INT-SG</b>	Switches the input line to INT-SG.	Edge operation
<b>SD ASPECT</b>	Sets the aspect ratio for SD signal input. (Disabled during HD signal input)	Level operation (short-circuited: 16:9, open: 4:3)
<b>SCAN</b>	Switches the scan mode between UNDER and NORMAL.	Level operation (Short-circuited: UNDER, Open: NORMAL)
<b>R-TALLY</b> *3	Lights the red tally.	Level operation (Short-circuited: ON, Open: OFF)
<b>G-TALLY</b> *3	Lights the green tally.	Level operation (Short-circuited: ON, Open: OFF)
<b>MONO</b>	Switches between color and monochrome (MONO).	Level operation (Short-circuited: monochrome, Open: color)
<b>GAMMA SEL. FILM</b>	Switches the gamma curve to FILM mode.	Level operation (Short-circuited: FILM mode, Open: STANDARD mode)
<b>GAMMA SEL. STUDIO/PST</b>	Switches the gamma curve to STUDIO/PST mode.	Level operation (Short-circuited: STUDIO/PST mode, Open: STANDARD mode)
<b>GAMMA SEL. CINEMA</b>	Switches the gamma curve to CINEMA mode.	Level operation (Short-circuited: CINEMA mode, Open: STANDARD mode)

\*1 When a 16:9 marker and a 4:3 marker are simultaneously selected and activated on a 16:9 aspect ratio display, both markers are displayed.

\*2 When a 16:9 marker and a 4:3 marker are simultaneously displayed, the background of the marker selected by the 16:9 marker is controlled.

\*3 When [R-TALLY] and [G-TALLY] simultaneously go on, the tally color changes to amber.



## REMOTE Specifications (continued)

Assigned item	Function	Operating conditions
<b>PIXEL TO PIXEL</b>	Switches screen display between input size and display size.	Level operation (Short-circuited: ON, Open: OFF)
<b>FOCUS-IN-RED</b>	Displays the outlines of the subject that are in focus in red	Level operation (Short-circuited: ON, Open: OFF)
<b>ZEBRA</b>	Superimposes the ZEBRA pattern over an area of the image with a specified brightness signal level.	Level operation (Short-circuited: ON, Open: OFF)
<b>REMOTE STANDBY *4*5</b>	Sets REMOTE STANDBY (the backlight is turned off).	Level operation (Short-circuited: ON, Open: OFF)

\*4 When remote standby is set to ON, the front panel power LED flashes.

\*5 When you use a menu to set this function after short-circuiting the GPI input terminal to which it will be assigned, the backlight goes out and the screen display goes blank making it impossible to check menu operation.  
To change the setting of this item, be sure to set it when the GPI input terminal is in the open state.

### Restrictions

- The same restrictions apply as during FUNCTION operations.

### ■ Priority of assigned functions

- When both [MARKER1 ON/OFF] and [MARKER2 ON/OFF] are activated at the same time, "MARKER1" has priority. However, when the display aspect ratio is 4:3, the "MARKER1" aspect ratio is 16:9 and the "MARKER2" aspect ratio is 4:3, "MARKER2" is displayed. In this case, the "MARKER2" background is controlled.
- When [MARKER BACK HALF] and [MARKER BACK BLACK] are activated at the same time, [MARKER BACK BLACK] has priority.
- When [GAMMA SEL. FILM], [GAMMA SEL. STUDIO/PST] and [GAMMA SEL. CINEMA] are simultaneously activated, priority goes to [GAMMA SEL. FILM]. The three modes in order of priority are: [GAMMA SEL. FILM] > [GAMMA SEL. STUDIO/PST] > [GAMMA SEL. CINEMA].

**RS-232C input terminal**

External operations can be performed via the RS-232C interface.

For details on the pin arrangement and RS-232C input terminal connections, refer to the diagram below and the table below right.

For details on specific systems using RS-232C input terminals, contact your supplier.

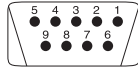

RS-232C input terminal (9 pins)

■ **Connectors and signals**  
**Connector: D-SUB 9-pin (female)**  
**Signal**

Pin number	Signal	Description
1	N.C.	Not connected
2	TXD	Transmission data
3	RXD	Reception data
4	DSR	Connected inside
5	GND	Ground
6	DTR	Connected inside
7	CTS	Connected inside
8	RTS	Connected inside
9	N.C.	Not connected

■ **Communication parameters**

Signal level	RS-232C compliant
Synchronous system	Asynchronous system
Transfer rate	9,600 bps
Parity	None
Data length	8 bit
Stop bit	1 bit
Flow control	None

External Device Side (Straight)

Pin number	Signal
1	N.C.
2	RXD
3	TXD
4	DTR
5	GND
6	DSR
7	RTS
8	CTS
9	N.C.

Device side

Pin number	Signal
1	N.C.
2	TXD
3	RXD
4	DSR
5	GND
6	DTR
7	CTS
8	RTS
9	N.C.

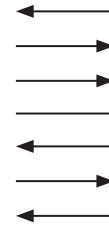

■ **Command format**

STX (02h)	Command	:	Data	ETX (03h)
-----------	---------	---	------	-----------

- The command is the 3-character string starting with STX and ending with ETX.
- Append any data after the colon (:) following the command, as required.

■ **Response formats**

**1. Setting command response**

STX (02h)	Command	ETX (03h)
-----------	---------	-----------

**2. Query command response**

STX (02h)	Data	ETX (03h)
-----------	------	-----------

**3. Error response**

STX (02h)	Error codes	ETX (03h)
-----------	-------------	-----------

- Error codes
- ER001: Invalid command
  - ER002: Parameter error

## REMOTE Specifications (continued)

### RS-485 input/output terminal

The RS-485 interface enables external operations.

The figures below show RS-485 input/output terminal pin arrangement and connections.

TSL protocol version 3.1 and 4.0 are supported. Make sure that the same TSL protocol versions are used on external control devices and the monitor.

For information on specific systems using RS-485 input terminals, contact your supplier.

Connection example

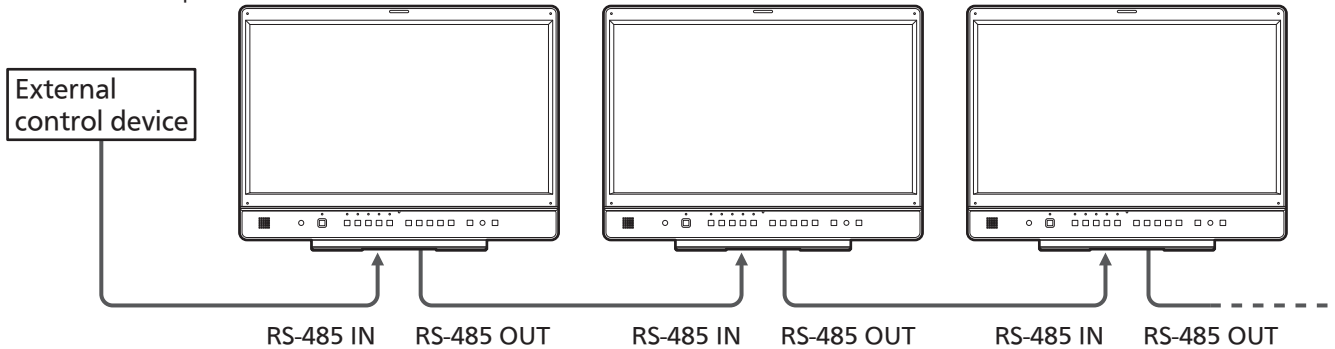

- A loop-through connection using the RS-485 input and output terminals allows operation of multiple monitors (up to 32 monitors).
- Connect a terminator (120 Ω) between the first and second pin of the OUT terminal on the last monitor in the chain.

#### ■ Connectors and signals

Connector: 8-pin RJ-45 connector



Pin number		Signal	Description
IN (input)	OUT (output)		
1	3	RXD+	Received data (+)
2	6	RXD-	Received data (-)
3	1	TXD+	Send data (+)
4	4	N.C.	Not connected
5	5	N.C.	Not connected
6	2	TXD-	Send data (-)
7	7	N.C.	Not connected
8	8	GND	Ground

#### ■ Communication parameters

Synchronous system	Asynchronous system
Transfer rate	38,400 bps
Parity	EVEN
Data length	8 bit
Stop bit	1 bit
Flow control	None

#### ■ Command format

STX (02h)	Header (ID)	Command	Data	EXT (03h)
-----------	-------------	---------	------	-----------

The header (ID) is 8-bit data.

Use the [RS-485 ID SETUP] function in the [SYSTEM CONFIG] menu to set up.

Setting the most significant bit on an external control device allows you to switch between TSL protocol support and "Setting command" (→page64)/"Query commands" support (→page 67). Example: RS-485 ID SETUP 31 setting (hexadecimal conversion)

⇒Header 1Fh (for support of commands listed below)

Header 9Fh (for TSL protocol support)

When 0 is set in [RS-485 ID SETUP], multiple monitors can be controlled.

#### ■ Response formats

##### 1. Setting command response

STX (02h)	Command	EXT (03h)
-----------	---------	-----------

##### 2. Query command response

STX (02h)	Data	EXT (03h)
-----------	------	-----------

##### 3. Error response

STX (02h)	Error codes	EXT (03h)
-----------	-------------	-----------

Error codes

ER001: Invalid command

ER002: Parameter error

When 0 is set in [RS-485 ID SETUP], operation is enabled but responses are not.

After receiving a monitor response command, there should be a time lag of approx. 200 ms before a command is transmitted from an external control device.

## REMOTE Specifications (continued)

### ■ Setting command

No	Send commands	Command name	Data	Return
1	IIS:<data>	INPUT SELECT	0:SDI1 1:SDI2 2:VIDEO 6:DVI 8:HDMI 9:INT-SG	IIS
2	VPC:CON<data>	CONTRAST	00 to 60	VPC
3	VPC:BRI<data>	BRIGHT	00 to 60	VPC
4	VPC:CRO<data>	CHROMA	00 to 60	VPC
5	VPC:PHA<data>	PHASE	00 to 60	VPC
6	VPC:VOL<data>	VOLUME	00 to 60	VOL
7	VBL:<data>	BACKLIGHT	000 to 100	VBL
8	DMK:MK1<data>	MARKER 16:9	00:OFF 01:80 % 02:88 % 03:93 % 04:95 % 05:14:9 06:13:9 07:4:3 08:90 % 09:CNSCO2.35 10:VISTA 11:2:1 12:CNSCO2.39 080 to 100:USER80 % to 100 % xxxxyy:VAR.H.80 % to 100 % V.80 % to 100 % (xxx:080 to 100 yyy:080 to 100)	DMK
9	DMK:MK2<data>	MARKER 4:3	00:OFF 01:80 % 02:88 % 03:93 % 04:95 % 08:90 % 080 to 100:USER80 % to 100 % xxxxyy:VAR.H.80 % to 100 % V.80 % to 100 % (xxx:080 to 100 yyy:080 to 100)	DMK
10	DMK:BAK<data>	MARKER BACK	0:NORMAL 1:HALF 2:BLACK	DMK
11	DMK:CMK<data>	CENTER MARKER	0:OFF 1:ON	DMK
12	DCH:<data>	CROSS HATCH	0:OFF 1:LOW 2:HIGH	DCH
13	DCW:<data>	CROSS HATCH WIDTH	0:SMALL 1:LARGE	DCW
14	DMK:MCO<data>	MARKER COLOR	0:WHITE 1:BLACK 2:RED 3:GREEN 4:BLUE	DMK
15	DMK:VMK<data>	CROSS MARKER	xxxxyyyy: Position range 00000000(off) (xxxx:0020 to 1899 yyyy:0020 to 1059)	DMK
16	MGM:<data>	GAMMA SELECT	1:STANDARD 2:FILM 3:STUDIO/PST 4:CINEMA	MGM
17	MCT:<data>	COLOR TEMP	00:D56 01:D65 02:D93 03:VAR1 04:VAR2 05:VAR3 10 to 73:USER0 to 63	MCT
18	VPC:SHP<data>	SHARPNESS MODE	0:LOW 1:HIGH	VPC
19	VPC:SHH<data>	SHARPNESS H	00 to 30: Horizontal sharpness setting	VPC
20	VPC:SHV<data>	SHARPNESS V	00 to 30: Vertical sharpness setting	VPC
21	MIP:<data>	IP MODE	0:MODE1 1:MODE2	MIP
22	OMO:<data>	MONO	1:OFF 2:ON	OMO
23	MAS:<data>	SD ASPECT	0:16:9 1:4:3	MAS
24	MSC:<data>	SCAN	0:NORMAL 1:UNDER	MSC
25	OZB:<data>	ZEBRA	0:OFF 1:INT. 2:EXT. 3:INT.+EXT.	OZB
26	OZI:<data>	ZEBRA LEVEL INT.	xxxxyy: INT. range (-07 to 000 to 109) (xxx: MIN value yyy: MAX value)	OZI
27	OZE:<data>	ZEBRA LEVEL EXT.	xxxxyy: EXT. range (-07 to 000 to 109) (xxx: MIN value yyy: MAX value)	OZE
28	DSD:<data>	STATUS DISP	0:CONTINUE 1:3SEC OFF 2:OFF	DSD
29	SCS:<data>	COLOR SPACE	0:SMPTE-C 1:EBU 2:ITU709	SCS
30	ISM:VNS<data>	NTSC SETUP	0:OFF 1:7.5 %	ISM
31	ISM:TDA<data>	DVI TYPE	0:DIGITAL 1:ANALOG	ISM
32	ISM:DVD<data>	DVI DIGITAL MODE	0:AUTO 1:VIDEO 2:COMP.	ISM
33	ISM:DVA<data>	DVI ANALOG MODE	0:Y <sub>P</sub> P <sub>R</sub> 1:RGB-COMP.	ISM
34	MCO:<data>	CONTROL	0:LOCAL 1:REMOTE	MCO
35	MLE:<data>	LOCAL ENABLE	0:DISABLE 1:INPUT 2:FUNCTION 3:INPUT+FUNC.	MLE
36	OBO:<data>	BLUE ONLY	0:OFF 1:ON	OBO
37	OHV:<data>	HV DELAY	0:OFF 1:H DELAY 2:V DELAY 3:HV DELAY	OHV
38	MBM:<data>	BLACK MODE	0:OFF 1:ON	MBM
39	MSB:<data>	SUB WINDOW	0:SINGLE 1:FULL/PART 2:STILL	MSB

## REMOTE Specifications (continued)

No	Send commands	Command name	Data	Return
40	MWC:<data>	TWO WINDOW	0:SINGLE 1:TWO M/M	MWC
41	DWM:<data>	WFM/VECTOR	0:OFF 1:WFM Y ON 2:WFM R ON 3:WFM G ON 4:WFM B ON 5:VECTOR ON	DWM
42	VWB:RGN<data>	WHITE BALANCE (R GAIN)	0 to 1023 RED GAIN setting	VWB
43	VWB:GGN<data>	WHITE BALANCE (G GAIN)	0 to 1023 GREEN GAIN setting	VWB
44	VWB:BGN<data>	WHITE BALANCE (B GAIN)	0 to 1023 BLUE GAIN setting	VWB
45	VWB:RBS<data>	WHITE BALANCE (R BIAS)	0 to 1023 RED BIAS setting -512 to 511	VWB
46	VWB:GBS<data>	WHITE BALANCE (G BIAS)	0 to 1023 GREEN BIAS setting-512 to 511	VWB
47	VWB:BBS<data>	WHITE BALANCE (B BIAS)	0 to 1023 BLUE BIAS setting-512 to 511	VWB
48	MPP:<data>	PIXEL TO PIXEL	0:OFF 1:ON	MPP
49	DPO:<data>	PIXEL POSITION	0:CENTER 1:LEFT 2:RIGHT	DPO
50	MFR:<data>	FOCUS IN RED	0:OFF 1:ON	MFR
51	DLM:<data>	LEVEL METER	0:OFF 1:2CH 2:4CH 3:8CH	DLM
52	DTM:<data>	TIME CODE	0:OFF 1:LTC 2:VITC 3:LUB 4:VUB 5:LTC+LUB 6:VITC+VUB	DTM
53	MCC:<data>*1	CLOSED CAPTION	00:OFF 01:CC1(CEA-608(VBI)) 02:CC2(CEA-608(VBI)) 03:CC3(CEA-608(VBI)) 04:CC4(CEA-608(VBI)) 05:SRV1(CEA-708) 06:SRV2(CEA-708) 07:SRV3(CEA-708) 08:SRV4(CEA-708) 09:SRV5(CEA-708) 10:SRV6(CEA-708) 11:OP-42 12:OP-47 13:CC1(CEA-608(ANC)) 14:CC2(CEA-608(ANC)) 15:CC3(CEA-608(ANC)) 16:CC4(CEA-608(ANC)) 17:CC1(CEA-608(708)) 18:CC2(CEA-608(708)) 19:CC3(CEA-608(708)) 20:CC4(CEA-608(708))	MCC
54	MAN:<data>	ANAMO	0:OFF 1:ON	MAN
55	OYM:<data>	Y MAP	0:OFF 1:ON	OYM
56	OPA:<data>*2	PICTURE ASSIST	0:OFF 1:ON	OPA
57	ORC:<data>	R COLOR	0:OFF 1:ON	ORC
58	OGC:<data>	G COLOR	0:OFF 1:ON	OGC
59	OBC:<data>	B COLOR	0:OFF 1:ON	OBC
60	DIS:WVP<data>	WFM/VECTOR POSITION	0:RT 1:RB 2:LB 3:LT	DIS
61	DIS:VMO<data>	VECTOR MODE	0:x1 1:x2S 2:x2 3:x4 4:x8	DIS
62	DIS:VSC<data>	VECTOR SCALE	0:100 % 1:75 %	DIS
63	DIS:TMP<data>	TIMECODE POSITION	0:TOP 1:RIGHT 2:CENTER 3: LEFT	DIS
64	DIS:TFS<data>	TIMECODE FONT SIZE	0:LARGE 1:SMALL	DIS
65	DIS:IMD<data>	IN MONITOR DISPLAY	0:OFF 1:ON	DIS
66	DIS:IMP<data>	IN MONITOR DISPLAY POSITION	0:TOP 1:BOTTOM	DIS
67	DIS:IMC<data>	IN MONITOR DISPLAY CHAR. COLOR	0: CMD (RS-485 setting) 1: WHITE 2: BLUE 3:GREEN 4:YELLOW 5:CYAN 6:RED 7:GRAY 8:MAGENTA	DIS
68	DIS:IMV<data>	IN MONITOR DISPLAY VERSION	0:Ver3.1 1:Ver4.0	DIS
69	AUD:IIS<data>	INPUT SELECT	0:AUTO 1:ANALOG	AUD
70	AUD:GSL<data>	GROUP SELECT	0:1 to 8 1:9 to 16	AUD
71	AUD:ISL<data>	SELECT L	0:1ch/9ch 1:2ch/10ch 2:3ch/11ch 3:4ch/12ch 4:5ch/13ch 5:6ch/14ch 6:7ch/15ch 7:8ch/16ch	AUD

\*1 Configures settings for the [CLOSED CAPTION], [CC TYPE], [CAPTION CHANNEL], [CAPTION SERVICE] menu items under [DISPLAY SETUP] simultaneously.

\*2 In 2-screen ([SUB WINDOW], [TWO WINDOW], [PICTURE ASSIST]) commands, a command input when another mode goes on changes priority to the input mode.  
(A switch to SINGLE, switches the monitor to single screen display.)

## REMOTE Specifications (continued)

No	Send commands	Command name	Data				Return
72	AUD:ISR<data>	SELECT R	0:1ch/9ch 4:5ch/13ch	1:2ch/10ch 5:6ch/14ch	2:3ch/11ch 6:7ch/15ch	3:4ch/12ch 7:8ch/16ch	AUD
73	AUD:OSL<data>	AUDIO OUT SEL.	0:SDI1	1:SDI2			AUD
74	AMT:<data>	AUDIO MUTE	0:OFF	1:ON			AMT

## REMOTE Specifications (continued)

### ■ Query commands

No	Command parameter	Description	Response data
1	QIS	INPUT SELECT	00:SDI1 01:SDI2 02:DVI-ANALOG-VIDEO 04:VIDEO 06:DVI-ANALOG-COMP. 09:DVI-DIGITAL-VIDEO 10:DVI-DIGITAL-COMP. 11:HDMI 12:INT-SG
2	QPC:CON	CONTRAST	00 to 60
3	QPC:BRI	BRIGHT	00 to 60
4	QPC:CRO	CHROMA	00 to 60
5	QPC:PHA	PHASE	00 to 60
6	QPC:VOL	VOLUME	00 to 60
7	QBL	BACKLIGHT	000 to 100
8	QMK:MAK	MARKER* <sup>3</sup>	00:OFF 01:80 % 02:88 % 03:93 % 04:95 % 05:14:9 06:13:9 07:4:3 08:90 % 09:CNSCO2.35 10:VISTA 11:2:1 12:CNSCO2.39 080 to 100:USER 80 % to 100 % xxxxyy:VAR.H.80 % to 100 % V.80 % to 100 % (xxx:080 to 100 yyy:080 to 100)
9	QMK:BAK	MARKER BACK	0:NORMAL 1:HALF 2:BLACK
10	QMK:CMK	CENTER MARKER	0:OFF 1:ON
11	QCH	CROSS HATCH	0:OFF 1:LOW 2:HIGH
12	QCW	CROSS HATCH WIDTH	0:SMALL 1:LARGE
13	QMK:COL	MARKER COLOR	0:WHITE 1:BLACK 2:RED 3:GREEN 4:BLUE
14	QMK:VMK	CROSS MARKER	xxxxyyy: Position range 00000000(off) (xxxx:0020 to 1899 yyy:0020 to 1059)
15	QGM	GAMMA SELECT	1:STANDARD 2:FILM 3:STDIO/PST 4:CINEMA
16	QCT	COLOR TEMP	00:D56 01:D65 02:D93 03:VAR1 04:VAR2 05:VAR3 10 to 73:USER0 to 63
17	QPC:SHP	SHARPNESS MODE	0:LOW 1:HIGH
18	QPC:SHH	SHARPNESS H	00 to 30: Horizontal sharpness set value
19	QPC:SHV	SHARPNESS V	00 to 30: Vertical sharpness set value
20	QIP	IP MODE	0:MODE1 1:MODE2
21	QMO	MONO	1:OFF 2:ON
22	QAS	SD ASPECT	0:16:9 1:4:3
23	QSC	SCAN	0:NORMAL 1:UNDER
24	QZB	ZEBRA	0:OFF 1:INT. 2:EXT. 3:INT.+EXT.
25	QZI	ZEBRA LEVEL INT.	xxxxyy: INT. range (-07 to 000 to 109) (xxx:MIN value yyy:MAX value)
26	QZE	ZEBRA LEVEL EXT.	xxxxyy: EXT. range (-07 to 000 to 109) (xxx: MIN value yyy: MAX value)
27	QCS	COLOR SPACE	0:SMPTE-C 1:EBU 2:ITU709
28	QNS	NTSC SETUP	0:OFF 1:7.5 %
29	QDT	DVI TYPE	0:DIGITAL 1:ANALOG
30	QDD	DVI DIGITAL MODE	0:AUTO 1:VIDEO 2:COMP.
31	QDA	DVI ANALOG MODE	0:YPbPr 1:RGB-COMP.

\*<sup>3</sup> When both 16:9 and 4:3 markers are displayed, the 16:9 marker state is returned.

(Continued on next page)

## REMOTE Specifications (continued)

No	Command parameter	Description	Response data
32	QFR	FORMAT CHECK	00:NO SIGNAL 01:1080/60i 02:1080/59.94i 03:1080/50i,1080/25PsF 04:1080/30p 05:1080/29.97p 06:1080/25p 07:1080/24p 08:1080/23.98p 09:1080/24PsF 10:1080/23.98PsF 13:720/60p 14:720/59.94p 15:576/50i 16:480/59.94p 17:480/59.94i 18:576/50p 20:1080/60p 21:1080/59.94p 22:1080/50p 23:720/50p 51:640x480 54:800x600 57:1024x768 61:1280x768 63:1280x1024 70:1920x1080 FF:UNSUPPORT SIGNAL
33	QBO	BLUE ONLY	0:OFF 1:ON
34	QHV	HV DELAY	0:OFF 1:H DELAY 2:V DELAY 3:HV DELAY
35	QBM	BLACK MODE	0:OFF 1:ON
36	QSB	SUB WINDOW	0:SINGLE 1:FULL/PART 2:STILL
37	QWC	TWO WINDOW	0:SINGLE 1:TWO M/M
38	QWM	WFM/VECTOR	0:OFF 1:WFM Y ON 2:WFM R ON 3:WFM G ON 4:WFM B ON 5:VECTOR ON
39	QWB:RGN	WHITE BALANCE R-GAIN	0 to 1023: RED GAIN set value
40	QWB:GGN	WHITE BALANCE G-GAIN	0 to 1023: GREEN GAIN set value
41	QWB:BGN	WHITE BALANCE B-GAIN	0 to 1023: BLUE GAIN set value
42	QWB:RBS	WHITE BALANCE R-BIAS	0 to 1023: RED BIAS set value -512 to 511
43	QWB:GBS	WHITE BALANCE G-BIAS	0 to 1023: GREEN BIAS set value -512 to 511
44	QWB:BBS	WHITE BALANCE B-BIAS	0 to 1023: BLUE BIAS set value -512 to 511
45	QPP	PIXEL TO PIXEL	0:OFF 1:ON
46	QPO	PIXEL POSITION	0:CENTER 1:LEFT 2:RIGHT
47	QFI	FOCUS IN RED	0:OFF 1:ON
48	QLM	LEVEL METER	0:OFF 1:2ch 2:4ch 3:8ch
49	QTM	TIME CODE	0:OFF 1:LTC 2:VITC 3:LUB 4:VUB 5:LTC+LUB 6:VITC+VUB
50	QCC*4	CLOSED CAPTION	00:OFF 01:CC1(CEA-608(VBI)) 02:CC2(CEA-608(VBI)) 03:CC3(CEA-608(VBI)) 04:CC4(CEA-608(VBI)) 05:SRV1(CEA-708) 06:SRV2(CEA-708) 07:SRV3(CEA-708) 08:SRV4(CEA-708) 09:SRV5(CEA-708) 10:SRV6(CEA-708) 11:OP-42 12:OP-47 13:CC1(CEA-608(ANC)) 14:CC2(CEA-608(ANC)) 15:CC3(CEA-608(ANC)) 16:CC4(CEA-608(ANC)) 17:CC1(CEA-608(708)) 18:CC2(CEA-608(708)) 19:CC3(CEA-608(708)) 20:CC4(CEA-608(708))
51	QAN	ANAMO	0:OFF 1:ON
52	QYM	Y MAP	0:OFF 1:ON
53	QPA	PICTURE ASSIST	0:OFF 1:ON
54	QRC	R COLOR	0:OFF 1:ON
55	QGC	G COLOR	0:OFF 1:ON
56	QBC	B COLOR	0:OFF 1:ON
57	QWV	WFM/VEC POSITION	0:RT 1:RB 2:LB 3:LT
58	QVM	VECTOR MODE	0:x1 1:x2S 2:x2 3:x4 4:x8
59	QVS	VECTOR SCALE	0:100 % 1:75 %
60	QTP	TIMECODE POSITION	0:TOP 1: RIGHT 2:CENTER 3:LEFT
61	QTF	TIMECODE FONT SIZE	0:LARGE 1:SMALL
62	QMD	IN MONITOR DISPLAY	0:OFF 1:ON
63	QMP	IN MONITOR DISPLAY POSITION	0:TOP 1:BOTTOM

\*4 Responds to the states set in the [CLOSED CAPTION], [CC TYPE], [CAPTION CHANNEL], [CAPTION SERVICE] menu items under [DISPLAY SETUP].



## REMOTE Specifications (continued)

No	Command parameter	Description	Response data
64	QMC	IN MONITOR DISPLAY CHAR. COLOR	0: CMD (RS-485 setting) 1: WHITE 2: BLUE 3: GREEN 4: YELLOW 5: CYAN 6: RED 7: GRAY 8: MAGENTA
65	QMV	IN MONITOR DISPLAY VERSION	0: Ver3.1 1: Ver4.0
66	QAI	INPUT SELECT	0: AUTO 1: ANALOG
67	QGS	GROUP SELECT	0: 1 to 8 1: 9 to 16
68	QSL	SELECT L	0: 1ch/9ch 1: 2ch/10ch 2: 3ch/11ch 3: 4ch/12ch 4: 5ch/13ch 5: 6ch/14ch 6: 7ch/15ch 7: 8ch/16ch
69	QSR	SELECT R	0: 1ch/9ch 1: 2ch/10ch 2: 3ch/11ch 3: 4ch/12ch 4: 5ch/13ch 5: 6ch/14ch 6: 7ch/15ch 7: 8ch/16ch
70	QMT	AUDIO MUTE	0: OFF 1: ON
71	QOS	AUDIO OUT SEL.	0: SDI1 1: SDI2
72	QID	MODEL CHECK	BT-LH2170

# Maintenance Inspections

---

Maintenance inspections through periodic and appropriate maintenance are essential to keep the monitors in optimum condition and ensure safe operation. Be sure to conduct the following maintenance inspections to enable long-term and full use of all its functions.

## **Necessity of periodic maintenance service**

The backlight in the LCD panel is a consumable component that deteriorates over time leading to gradual loss of performance that could eventually result in a malfunction.

Conventional after-sales service that replaces parts when they break down should therefore be combined with a regularly conducted comprehensive service to maintain normal operation and prevent unforeseen breakdown of consumables.

# Error and Warning Information

---

If for any reason an error occurs in the monitor, the following indications are made to notify the error or warning.

Error and Warning Information	Symptom	Remedy
<b>Warning of drop in external DC input voltage/ LOW VOLTAGE</b>	A [LOW VOLTAGE] indication in blue flashes on the screen. This means that the external DC power supply input voltage has dropped to approximately 11.3 V or less.	If the monitor has powered down, connect an external DC power supply providing 11.0 V or more and turn the POWER switch ON.
	The [LOW VOLTAGE] indication lights red on the screen and the power is turned off approximately 4 seconds later. This means that the external DC power supply input voltage has dropped below approximately 11.0 V.	

## Maintenance

---

- Clean the cabinet and LCD panel by gently wiping them with a soft cloth. To remove stubborn soiling, use a cloth dampened in a weak neutral detergent solution and thoroughly wrung out. Then wipe with a dry cloth. Any moisture entering the monitor could damage it.
- Never use alcohol, thinner or benzene to clean this monitor. They could discolor the surface and cause the paint to peel.
- Do not directly expose the monitor to spray cleaning. Any moisture entering the monitor could damage it.

# Specifications

## ■ General

### Power input

Power supply voltage	Current consumption
AC : 100 V - 240 V, 50/60 Hz	0.55 A - 0.25 A
DC : 12 V (11 V - 17 V)	3.8 A

 indicates safety information.

Dimensions (W x H x D):	510 mm×388 mm×198 mm ( 20-1/16 inches x 15-1/4 inches x 7-13/16 inches) (including stand) 510 mm×373 mm×72 mm ( 20-1/16 inches x 14-5/8 inches x 2-13/16 inches) (monitor only, not including stand)
Mass:	7.0 kg (15.43 lb) (including stand) 6.1 kg (13.45 lb) (monitor only, not including stand)
Operating temperature:	5 °C to 35 °C (41 °F to 95 °F)
Operating humidity:	20 % to 80 % (no condensation)
Storage temperature:	- 20 °C to 60 °C (-4 °F to 140 °F)

## ■ Display panel

Dimensions:	54.6 cm (21.5 inches) (effective screen area)
Aspect ratio:	16:9
Number of pixels:	1920 x 1080 (Full HD)
Display colors:	Approx. 16,700,000 colors
View angle (contrast > 10:1):	178° left/right, 178° up/down

## ■ Input/output Connectors

VIDEO input:	BNC x 1
SDI input:	BNC x 2 SMPTE ST 424, 274, 296, 259, ITU-R BT.656-4 compliant EMBEDDED AUDIO supported 3G-SDI: SMPTE ST 299 compliant 48 kHz, synchronous supported 16 channels supported HD-SDI: SMPTE ST 299 compliant 48 kHz, synchronous compatible 8 channels supported SD-SDI: SMPTE ST 272 compliant 48 kHz, synchronous compatible 4 channels supported
HDMI input:	HDMI terminal x 1 (Type A terminal) HDCP supported EMBEDDED AUDIO supported VIERA Link not supported
DVI-I input:	DVI-I, 29-pin plug x 1 single link HDCP supported
AUDIO input:	Pin jack x 2 (stereo) Input signal level: 0.31 Vrms
VIDEO output (through-out):	BNC x 1
SDI output (active through-out):	BNC×2
GPI:	D-SUB, 9 pins x 1
RS-232C:	D-SUB, 9 pins x 1
RS-485:	RJ-45 x 2 (input, output)
Headphones:	Stereo mini jack M3 x 1, 32 Ω, level adjustable

## ■ Other Input/output connectors

Speaker output:	Monaural 0.5 W
Tally output (display):	Red, green, amber

Weight and dimensions are approximate.

Inrush current, measured according to European standard EN 55103-1: 8 A

## Specifications (continued)

### ■ List of supported video input signal formats in 2D mode (✓: Supported)

Input signal format/ Status display	VIDEO	SDI1	SDI2	HDMI	DVI-I	
					ANALOG	DIGITAL
					YPbPr	VIDEO
NTSC	✓					
PAL	✓					
480/59.94i		✓	✓	✓	✓	✓
480/59.94p				✓	✓	✓
576/50i		✓	✓	✓	✓	✓
576/50p				✓	✓	✓
720/50p		✓	✓	✓	✓	✓
720/59.94p		✓	✓	✓	✓	✓
720/60p		✓	✓	✓	✓	✓
1035/59.94i *1		✓	✓	✓	✓	✓
1035/60i *2		✓	✓	✓	✓	✓
1080/23.98PsF		✓	✓		✓	
1080/24PsF		✓	✓		✓	
1080/25PsF *3		✓	✓		✓	
1080/50i		✓	✓	✓	✓	✓
1080/59.94i		✓	✓	✓	✓	✓
1080/60i		✓	✓	✓	✓	✓
1080/23.98p		✓	✓	✓	✓	✓
1080/24p		✓	✓	✓	✓	✓
1080/25p		✓	✓	✓	✓	✓
1080/29.97p		✓	✓	✓	✓	✓
1080/30p		✓	✓	✓	✓	✓
1080/50p		✓		✓		✓
1080/59.94p		✓		✓		✓
1080/60p		✓		✓		✓

\*1 When a 1035/59.94i signal is input, images are displayed in 1080/59.94i. Then the displayed markers are also for 1080/59.94i.

\*2 When a 1035/60i signal is input, images are displayed in 1080/60i. Then the displayed markers are also for 1080/60i.

\*3 When a 1080/25PsF signal is input, images are displayed in 1080/50i. Then the displayed markers are also for 1080/50i.

### ■ List of supported PC input signal formats (✓: Supported)

Input signal format *5 / Status display *6	HDMI	DVI-I	
		ANALOG	DIGITAL
		RGB-COMP.	COMP.
640×480	✓	✓	✓
800×600	✓	✓	✓
1024×768	✓	✓	✓
1280×768	✓	✓	✓
1280×1024	✓	✓	✓
1920×1080	✓*4	✓	✓*7

\*4 An HDMI 1920 × 1080 (60 Hz) PC signal is displayed as a 1080/60p VIDEO signal.

\*5 The frame frequency supports 60 Hz only.

\*6 The frame frequency is not displayed.

\*7 When [DVI-I] is set to [DIGITAL] and [DIGITAL] is set to [DVI-AUTO], 1080/60p VIDEO signals are displayed.

## Specifications (continued)

### ■ List of Compatible 3G-SDI Input Signal Formats

Input terminal	level	Format	Pixel resolution	Bit	Interlaced Progressive	Frequency
SDI1	A	1920x1080	4:2:2(YCbCr)	10	Progressive	60* <sup>2</sup> , 50
			4:4:4(RGB), 4:4:4:4(RGB+A)	10	Interlaced	60* <sup>2</sup> , 50
					Progressive	30* <sup>2</sup> , 25, 24* <sup>2</sup>
			4:4:4(YCbCr), 4:4:4:4(YCbCr+A)	10	Interlaced	60* <sup>2</sup> , 50
					Progressive	30* <sup>2</sup> , 25, 24* <sup>2</sup>
			4:4:4(RGB)	12	Interlaced	60* <sup>2</sup> , 50
		Progressive			30* <sup>2</sup> , 25, 24* <sup>2</sup>	
		4:4:4(YCbCr)	12	Interlaced	60* <sup>2</sup> , 50	
				Progressive	30* <sup>2</sup> , 25, 24* <sup>2</sup>	
		4:2:2(YCbCr)	12	Interlaced	60* <sup>2</sup> , 50	
				Progressive	30* <sup>2</sup> , 25, 24* <sup>2</sup>	
		1280x720	4:4:4(RGB), 4:4:4:4(RGB+A)	10	Progressive	60* <sup>2</sup> , 50
	4:4:4(YCbCr), 4:4:4:4(YCbCr+A)		10	Progressive	60* <sup>2</sup> , 50	
	B-DL	1920x1080	4:2:2(YCbCr)	10	Progressive	60* <sup>2</sup> , 50
			4:4:4(RGB), 4:4:4:4(RGB+A)	10	Interlaced	60* <sup>2</sup> , 50
					Progressive	30* <sup>2</sup> , 25, 24* <sup>2</sup>
			4:4:4(YCbCr), 4:4:4:4(YCbCr+A)	10	Interlaced	60* <sup>2</sup> , 50
					Progressive	30* <sup>2</sup> , 25, 24* <sup>2</sup>
			4:4:4(RGB)	12	Interlaced	60* <sup>2</sup> , 50
		Progressive			30* <sup>2</sup> , 25, 24* <sup>2</sup>	
		4:4:4:(YCbCr)	12	Interlaced	60* <sup>2</sup> , 50	
Progressive				30* <sup>2</sup> , 25, 24* <sup>2</sup>		
4:2:2(YCbCr)		12	Interlaced	60* <sup>2</sup> , 50		
			Progressive	30* <sup>2</sup> , 25, 24* <sup>2</sup>		
B-DS* <sup>1</sup>		2x1920x1080	4:2:2(YCbCr)	10	Interlaced	60* <sup>2</sup> , 50
	Progressive				30* <sup>2</sup> , 25, 24* <sup>2</sup>	
	2x1280x720	4:2:2(YCbCr)	10	Progressive	60* <sup>2</sup> , 50	

\*<sup>1</sup> Displays only data stream 1.

\*<sup>2</sup> The frame frequency of 1/1.001 is also supported.

## Specifications (continued)

---

### ■ List of Signal Formats Supported in 3D Assist Mode

(✓: Supported)

Input Signal Format/ Status displays	SDI1/2 (SIMULTANEOUS)
720/50p	✓
720/59.94p	✓
720/60p	✓
1035/59.94j*1	✓
1035/60j*2	✓
1080/23.98PsF	✓
1080/24PsF	✓
1080/25PsF*3	✓
1080/23.98p	✓
1080/24p	✓
1080/50i	✓
1080/59.94i	✓
1080/60i	✓

\*1 When a 1035/59.94i signal is input, images are displayed in 1080/59.94i.

\*2 When a 1035/60i signal is input, images are displayed in 1080/60i.

\*3 When a 1080/25PsF signal is input, images are displayed in 1080/50i.

## Specifications (continued)

### ■ Closed Caption Decoding

#### Supported Signals

<b>Composite</b>	NTSC, PAL
<b>SD-SDI</b>	480/59.94i, 576/50i
<b>HD-SDI</b>	1080/60i*1, 720/60p*1, 1080/50i, 720/50p, 1080/24PsF*1, 1080/25PsF, 1080/30p*1, 1080/24p*1, 1080/25p

#### Supported Standards

<b>Composite</b>	EIA/CEA-608 (VBI), OP-42
<b>SD-SDI</b>	EIA/CEA-608 (VBI), EIA/CEA-608 (ANC), OP-42
<b>HD-SDI</b>	EIA/CEA-608 (708), EIA/CEA-708, OP-47

#### Supported Specifications (EIA/CEA-608)

<b>Decode channels</b>	CC1 to CC4*2
<b>Character</b>	Standard Character, Special Character

#### Supported Specifications (EIA/CEA-708)

<b>Caption service</b>	Service #1 to #6
<b>Character</b>	G0 Code, G1 Code, Window Style*3, Pen Style*4

\*1 The frame frequency of 1/1.001 is also supported.

\*2 The XDS service is not supported

\*3 Window Style

Only justify LEFT is supported.

Only print direction LEFT-TO-RIGHT is supported.

Only scroll direction BOTTOM-TO-TOP is supported.

Word wrap is not supported.

Only the display effect SNAP is supported.

Fill color is not supported.

Fill opacity is not supported.

Border type is not supported.

\*4 Pen Style

Pen size SMALL is supported.

Font style is 0

Only offset NORMAL is supported.

Italics is supported.

Underline is supported.

Only edge type UNIFORM is supported.

Foreground colors white, blue, green, yellow, cyan, red, gray, and magenta are supported.

Foreground opacity is not supported.

Background colors black and orange (orange is displayed when any color other than black is specified) are supported.

Background opacity only black (semi-transparent) is supported.

#### Supported specifications (OP-42)

Only character code is supported

PAL and 576/50i are supported

#### Supported specifications (OP-47)

Only character code is supported

1080/50i and 1080/25PsF are supported

#### <Note>

3G-SDI signals are not supported.



**Specifications (continued)**

■ INT-SG (Internal chart for adjustment)

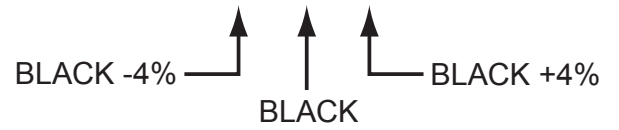
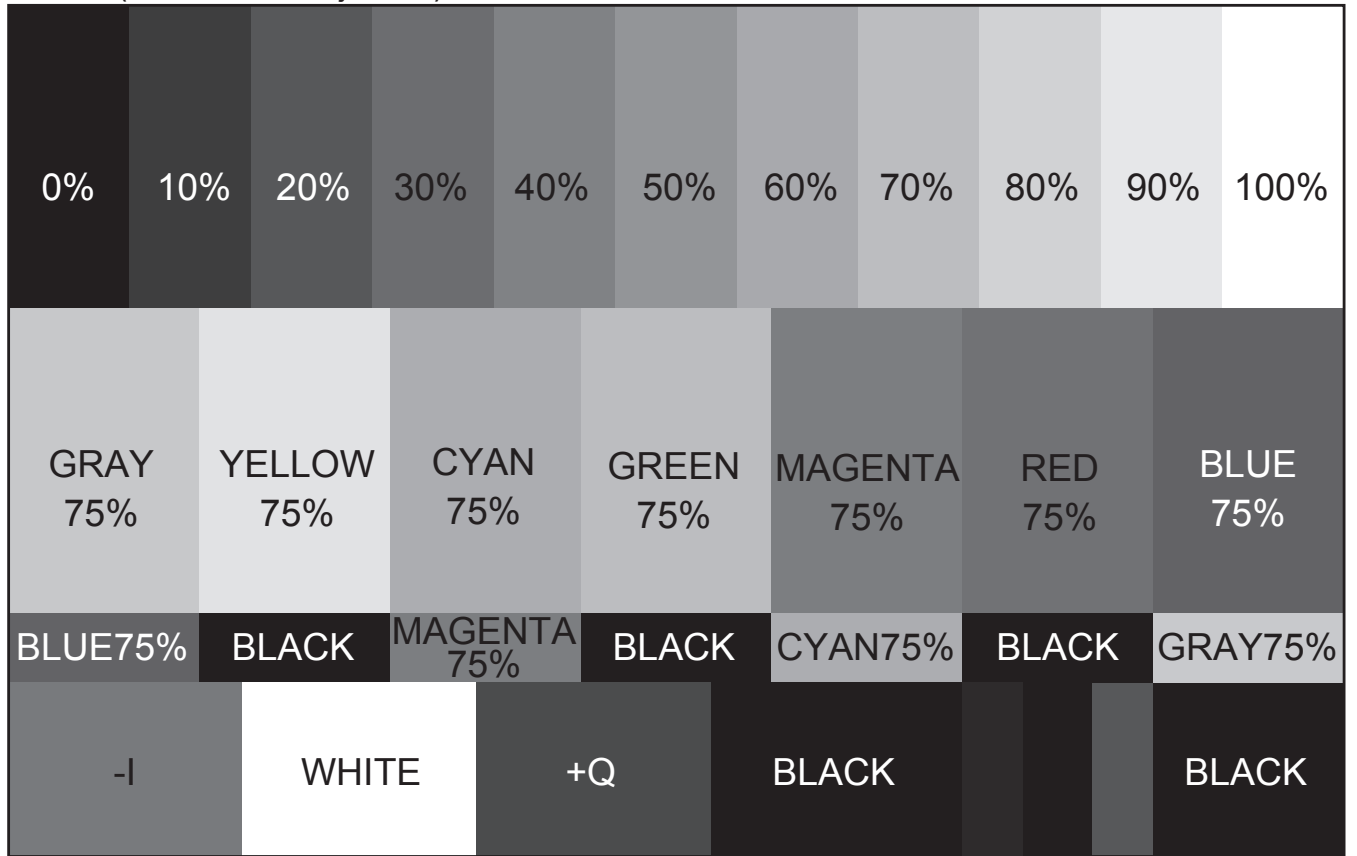

# Index

## Numerics

2D/3D ASSIST .....	24, 35
3D Assist Mode .....	49
4:3 .....	24
16:9 .....	24

## A

ANALOG .....	44
ANAMO .....	28, 35
AUDIO .....	45
AUDIO input terminal .....	13
AUDIO MUTE .....	35
AUDIO OUT SEL. ....	35
Audio volume .....	17, 21
Audio volume bar meter .....	18
AUTO CALIBRATION .....	32, 33

## B

BACK .....	24
BACKLIGHT .....	21
B COLOR .....	35
BIAS .....	29
BLACK MODE .....	34
BLUE .....	29
BLUE ONLY .....	34
BRIGHT .....	21

## C

CALIBRATION .....	30, 32
CAPTION CHANNEL .....	46
CAPTION SERVICE .....	47
CC TYPE .....	46
CENTER .....	25
Center marker .....	26
CHAR. COLOR .....	47
CH INFO. ....	45
CHROMA .....	21
CH SELECT .....	45
CLOCK .....	44
CLOSED CAPTION .....	35, 46
Closed captions .....	19
COLOR .....	25, 52
COLOR SPACE .....	30
COLOR TEMP. ....	27, 29
COMPARISON .....	51
COMPONENT LEVEL .....	44
CONTRAST .....	21
CONTROL .....	48
CONVERGENCE .....	51
CROSS .....	25
CROSS HATCH .....	25, 34, 42
Cross marker .....	26

## D

DC Power .....	14
DIGITAL .....	44
Dimensions .....	10
Direct adjustment mode .....	29
DISPLAY SETUP .....	46
DVI-I .....	44
DVI-I terminal .....	13

## E

Error .....	71
-------------	----

## F

FILM GAMMA .....	27
F-IN-R .....	21, 52
FOCUS-IN-RED .....	34, 43

FONT SIZE .....	46
FUNCTION .....	17, 34
FUNCTION buttons .....	12, 37
FUNCTION DISPLAY .....	35
FUNCTION menu .....	16, 20
FUNCTION skip function .....	38

## G

GAIN .....	29
GAMMA SELECT .....	27, 34
G COLOR .....	35
GPI .....	43
GPI CONTROL .....	43
GPI input terminal .....	13, 60
GPI MARKER1 .....	25
GPI MARKER2 .....	25
GREEN .....	29
GROUP SELECT .....	45

## H

H .....	50
HDMI terminal .....	13
HEADPHONES output jack .....	12
HEAD ROOM .....	45
HOURS METER .....	48
H POSITION .....	44
HV DELAY .....	34, 38

## I

IMD .....	19
IN MONITOR DISPLAY .....	19, 47
INPUT NAME SETUP .....	30, 31
INPUT SELECT button .....	12
INPUT SELECT .....	44, 45
INPUT SELECT menu .....	16, 20
INT-SG .....	77
I-P MODE .....	28

## L

LCD .....	48
LEVEL .....	52
LEVEL METER .....	34, 45
LOCAL ENABLE .....	48

## M

Main menu .....	16, 20, 23
MAIN MENU .....	16, 20
Maintenance .....	71
Maintenance Inspections .....	70
MANUAL .....	51
MARKER .....	24, 34
Type .....	26
MARKER1 .....	53
MARKER2 .....	53
MARKER TYPE .....	25
menu .....	
configuration .....	23
display .....	16
operation .....	20
MENU button .....	12
MENU POSITION .....	30
MIRROR .....	50
MKR POSI .....	54
MKR WIDTH .....	54
MODE SELECT .....	46
MONO .....	28, 34

## N

NTSC SETUP .....	44
------------------	----

## Index (continued)

### O

Operating status display .....	16
OPERATION .....	48
Optional units .....	9
OVERLAY .....	53, 54

### P

PEAKING .....	21
PHASE .....	21, 44
PICTURE .....	12
Picture adjusting menu .....	17, 21
PICTURE ASSIST .....	35, 41
PICTURE menu .....	17, 21
PIXEL POSITION .....	34, 42
PIXEL TO PIXEL .....	34, 42
POINT LINE .....	45
POSITION .....	46, 47
Power cable .....	14
POWER DOWN .....	30
POWER ON SETUP .....	30
POWER SAVE MODE .....	30
Power supply .....	14
POWER switch .....	12
Protective panel .....	11
PROTOCOL VER. ....	48

### R

R COLOR .....	35
RED .....	29
REMOTE .....	60
RESET .....	29, 32, 33, 44
RETURN button .....	12
RGB-COMP. ....	44
Rotary knob .....	12
RS-232C input terminal .....	13, 62
RS-485 ID SETUP .....	48
RS-485 input/output terminals .....	13, 63
RS-485 STX&ETX .....	48

### S

SCAN .....	28, 34
SD ASPECT .....	28, 34
SDI1 (L) .....	50
SDI2 (R) .....	50
SDI terminal .....	13
SELECT L .....	45
SELECT R .....	45
SETUP LOAD .....	30
SETUP SAVE .....	30
Sharpness .....	17
SHARPNESS H .....	27
SHARPNESS MODE .....	27
SHARPNESS V .....	27
SHIFT .....	50
SIZE .....	25, 52
Speaker .....	12
SPEAKER OUT .....	45
Specifications .....	72
SPEED .....	51
Stand .....	15
Standard accessories .....	9
STATUS DISPLAY .....	30
SUB WINDOW .....	30, 34, 38
SYSTEM CONFIG .....	30

### T

Tally lamp .....	11
Time code .....	18
TIME CODE .....	35, 46

TWO WINDOW .....	35, 41
------------------	--------

### U

UNDEF .....	35
User Data .....	22

### V

V .....	50
VECTOR MODE .....	46
VECTOR SCALE .....	46
VERTICAL .....	53
VIDEO .....	44
VIDEO CONFIG .....	27
VIDEO terminal .....	13
VOLUME button .....	12
V POSITION .....	44

### W

Warning .....	71
WB adjustment mode .....	29
WFM/VECTOR .....	34, 39, 46
WHITE BALANCE .....	29, 34

### Y

Y MAP .....	35, 40
-------------	--------

### Z

ZEBRA .....	28, 35, 40
ZEBRA LEVEL .....	35
ZOOM .....	52
ZOOM FOCUS .....	52

## Information on Disposal for Users of Waste Electrical & Electronic Equipment (private households)



This symbol on the products and/or accompanying documents means that used electrical and electronic products should not be mixed with general household waste. For proper treatment, recovery and recycling, please take these products to designated collection points, where they will be accepted on a free of charge basis. Alternatively, in some countries you may be able to return your products to your local retailer upon the purchase of an equivalent new product. Disposing of this product correctly will help to save valuable resources and prevent any potential negative effects on human health and the environment which could otherwise arise from inappropriate waste handling. Please contact your local authority for further details of your nearest designated collection point. Penalties may be applicable for incorrect disposal of this waste, in accordance with national legislation.

### For business users in the European Union

If you wish to discard electrical and electronic equipment, please contact your dealer or supplier for further information.

### Information on Disposal in other Countries outside the European Union

This symbol is only valid in the European Union.

If you wish to discard this product, please contact your local authorities or dealer and ask for the correct method of disposal.

## ENGLISH

■ **How to open the operating instruction manual PDF files**  
Discontinue installation if the installation screen of the software opens as a result of inserting the CD-ROM.  
When [INDEX.pdf] on the CD-ROM is opened, a list of the operating instruction manuals will be displayed.  
Click on the document name of the manual to be opened.

■ **Adobe® Reader® is required to read PDF files.**  
It can be downloaded from the home page of Adobe Systems.

## DEUTSCH

■ **Öffnen der PDF-Dateien der Bedienungsanleitung**  
Brechen Sie die Installation ab, falls beim Einlegen der CD-ROM der Installationsbildschirm der Software erscheint.  
Wenn [INDEX.pdf] auf der CD-ROM geöffnet wird, erscheint eine Liste der Bedienungsanleitungen.  
Klicken Sie auf den Dokumentennamen der zu öffnenden Anleitung.

■ **Zum Lesen der PDF-Dateien benötigen Sie Adobe® Reader®.**  
Dieses Programm kann von der Homepage von Adobe Systems heruntergeladen werden.

## FRANÇAIS

■ **Comment ouvrir les fichiers PDF des manuels du mode d'emploi**  
Arrêter l'installation si l'écran d'installation du logiciel s'ouvre quand le CD-ROM est inséré.  
Quand [INDEX.pdf] sur le CD-ROM s'ouvre, la liste des manuels du mode d'emploi s'affiche.  
Cliquer sur le nom du document correspondant au manuel à consulter.

■ **Adobe® Reader® est nécessaire pour lire les fichiers PDF.**  
Ce logiciel peut être téléchargé depuis la page d'accueil d'Adobe Systems.

## ITALIANO

■ **Come aprire i file dei manuali di istruzioni per l'uso**  
Se inserendo il CD-ROM si apre la schermata di installazione del software, interrompere l'installazione.  
Aprendo [INDEX.pdf] sul CD-ROM, viene visualizzato un elenco di manuali di istruzioni per l'uso.  
Fare clic sul nome del documento corrispondente al manuale da aprire.

■ **Per leggere i file PDF è necessario Adobe® Reader®.**  
Il programma può essere scaricato dal sito Web di Adobe Systems.

## ESPAÑOL

■ **Modo de abrir los archivos PDF que contienen el manual de las instrucciones de funcionamiento**  
Interrumpa la instalación si la pantalla de instalación del software se abre como resultado de insertar el CD-ROM.  
Cuando se abra [INDEX.pdf] en el CD-ROM se visualizará una lista de los manuales de instrucciones de funcionamiento.  
Haga clic en el nombre de documento del manual que va a abrir.

■ **Para leer los archivos PDF se necesita el programa Adobe® Reader®.**  
Este programa se puede descargar de la página inicial de Adobe Systems.