

Panasonic

The AG-CX350 Book



This document describes features
available since firmware **Version 2.01**

Table of contents

1. Features	5
1-1. Available format and record time	8
1-2. Applicable memory cards	9
2. Preparation before recording	10
2-1. Terminals	11
2-2. Accessory and tripod mounting holes	12
2-3. Audio setting	13
2-4. Recording/outputting 4 channel audio	14
2-5. User assignable buttons	16
2-5-1. Assigning functions	17
2-5-2. Assignable functions	17
3. MENU operations	19
3-1. MENU items overview	20
[CAMERA] MENU	21
3-1-1. SW MODE	21
3-1-2. AUTO SW	22
3-1-3. USER SW	23
[SCENE FILE] MENU	24
3-1-4. FILE SELECT	24
3-1-5. NAME EDIT	24
3-1-6. LOAD/SAVE/INITIALIZE	24
3-1-7. VFR	24
3-1-8. FRAME RATE	24
3-1-9. SYNC SCAN TYPE	25
3-1-10. SYNC SCAN	25
3-1-11. MASTER DTL	25
3-1-12. DTL CORING	25
3-1-13. DETAIL SETTING	25
3-1-14. SKIN TONE DTL A, B, C	26
3-1-15. SKIN TONE ZEBRA	26
3-1-16. SKIN TONE DTL SETTING	26
3-1-17. RB GAIN CONTROL SETTING	27
3-1-18. COLOR TEMP Ach SETTING	27
3-1-19. COLOR TEMP Bch SETTING	28
3-1-20. CHROMA LEVEL	28
3-1-21. CHROMA PHASE	28
3-1-22. MATRIX	28
3-1-23. MATRIX SETTING	29
3-1-24. COLOR CORRECTION	30
3-1-25. MASTER PED	31
3-1-26. RGB BLACK CONTROL SETTING	31
3-1-27. GAMMA MODE SEL	31
3-1-28. GAMMA SETTING	31
3-1-29. KNEE SETTING	32
3-1-30. WHITE CLIP SETTING	32
3-1-31. DRS (Dynamic Range Stretcher)	32
3-1-32. DRS EFFECT DEPTH	32
3-1-33. DNR	32
3-1-34. A.IRIS LEVEL	32
3-1-35. A.IRIS LEVEL EFFECT	32

[AUDIO] MENU	33
3-1-36. INPUT SETTINGS	33
3-1-37. REC CH SETTINGS	33
3-1-38. OUTPUT SETTINGS.....	34
3-1-39. ALARM.....	34
[VIDEO OUT/LCD/VF] MENU	35
3-1-40. VIDEO OUT SEL.....	35
3-1-41. SDI OUT	35
3-1-42. HDMI OUT	36
3-1-43. AV OUT	36
3-1-44. SD DOWNCON MODE	37
3-1-45. LCD	37
3-1-46. VF	37
3-1-47. LCD/VF HDR	37
3-1-48. INDICATOR	38
3-1-49. MARKER	40
3-1-50. FOCUS ASSIST	40
3-1-51. EI ASSIST.....	41
[RECORDING] MENU	42
3-1-52. FORMAT MEDIA	42
3-1-53. CLIP NAME.....	42
3-1-54. FILE SPLIT	42
3-1-55. 2SLOT FUNC.....	42
3-1-56. PRE REC.....	42
3-1-57. REC FUNCTION	42
3-1-58. TC/UB.....	43
3-1-59. REC COUNTER	43
3-1-60. TIME STAMP	43
[NETWORK] MENU	44
3-1-61. DEVICE SEL	44
3-1-62. NETWORK FUNC	44
3-1-63. IP REMOTE.....	44
3-1-64. STREAMING	44
3-1-65. NDIHX	45
3-1-66. LAN PROPERTY	45
3-1-67. WLAN PROPERTY.....	46
3-1-68. INFORMATION.....	47
3-1-69. UTILITY	47
[SYSTEM] MENU	48
3-1-70. FREQUENCY	48
3-1-71. FILE FORMAT	48
3-1-72. REC FORMAT	48
3-1-73. ASPECT	48
3-1-74. SUPER SLOW.....	48
3-1-75. SHOOTING MODE	48
[OTHERS] MENU	49
3-1-76. FILE.....	49
3-1-77. COLOR BARS	49
3-1-78. LED	49
3-1-79. CLOCK	50
3-1-80. USB DEVICE	50
3-1-81. INFORMATION.....	50
3-1-82. LANGUAGE.....	50
3-1-83. MENU INITIALIZE	50

[OPTION] MENU.....	51
3-1-84. AREA SETTINGS.....	51
4. Understanding advanced features	52
4-1. Understanding live streaming feature via YouTube, Facebook	53
4-2. Video/audio output.....	58
4-3. Understanding focus assist features	59
4-4. Understanding Dual memory card slots.....	60
4-5. Synchronizing timecode for multi-cam operation.....	61
4-6. Understanding Remote operation via CX ROP iPad app.....	62
4-7. Updating firmware.....	65
5. Understanding scenefile operations	66
5-1. Scene file presets	67
5-2. Expressing the texture of objects (detail enhancement)	68
5-3. Basic settings for Details.....	69
5-3-1. Detail control.....	70
5-3-2. DETAIL GAIN(+) (-) control.....	70
5-3-3. MASTER DETAIL control	71
5-3-4. DETAIL CORING control.....	72
5-3-5. LEVEL DEPENDENT control.....	73
5-3-6. KNEE APE control.....	73
5-4. Expressing the gradation of an image (Knee, Gamma).....	74
5-4-1. KNEE control	74
5-4-2. GAMMA settings	76
5-4-3. BLACK GAMMA control	77
6. Appendix	78
6-1. Battery runtime	79
6-2. Scene file preset.....	80
6-3. Output signals (SDI)	82
6-4. Output signals (HDMI)	83
6-5. Streaming format (Protocol RTMP)	84
6-6. Streaming format (Protocol NDI HX)	85
6-7. Error and warning system	86
6-8. Genuine accessories	91
6-9. Specification	93
6-10. Dimensions.....	99

1. Features

AG-CX350

Wide-Angle 24.5mm*¹ Optical 20x Zoom, plus i.Zoom



Panasonic boasts the world's largest market share in the aspherical lens segment. Its cutting-edge optical technology was maximized in the development of the integrated lens used in the AG-CX350. This lens has the industry's widest angle of 24.5mm*¹ on the wide end and allows recording of wide-angle images with minimal distortion, without the use of a conversion lens. The optical 20x zoom covers up to 490mm telephoto in all modes. Furthermore, the i.Zoom enables seamless zooming of up to 32x in HD or up to 24x in UHD from the telephoto end with no degradation in resolution. The AG-CX350 also comes with digital 2x/ 5x/ 10x zoom.*²

*¹ In 35mm equivalent. The AG-CX350's wide 24.5mm angle is the widest in the industry for UHD/FHD (16:9). In the segment of camcorders with integrated lens, the Panasonic AG-UX180 achieved the industry's widest angle of 24mm in UHD/24p (17:9). For UHD/FHD (16:9), 25.4mm is the widest angle in the industry. (Both as of January 2019, according to a Panasonic survey)

*² When using the digital zoom, picture quality degrades as the magnification rate increases.

New High-Definition, High-Sensitivity 1.0-type 15M MOS Sensor

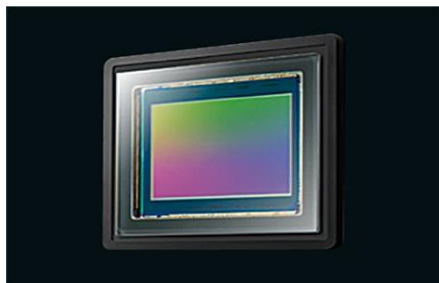

The 1.0-type MOS (approximately 15,030,000 pixels) offers an outstanding depth of field and excellent balance between image quality and sensitivity. It supports multi-formats, such as UHD (3840 x 2160), FHD, HD and SD, and provides images without cropping in all modes. This MOS sensor also boasts high sensitivity of F12 (60 Hz) /F13 (50 Hz) (in both UHD and FHD in High Sensitivity mode).

RTSP/RTMP/RTMPS-Compatible HD Streaming (P. 53)



HD streaming is possible while images are being acquired.*1 RTSP, RTMP and RTMPS streaming methods are compatible.*2 And Facebook, YouTube, and other streaming services are supported. The AG-CX350 can be used for live coverage of concerts and sports events as well as for live streaming of breaking news. Multicast streaming is also supported.

See 4-1. Understanding live streaming feature via YouTube, Facebook(P.53) for more details.

*1: There are some conditions under which streaming is not possible, such as when recording in UHD format or using NDI|HX mode. Please see the Operating Instruction Manual for details.

*2: The P2 Network Setting Software is convenient for setting up the RTMP and RTMPS functions. See the section, "Connectivity-verified live video services" for the live video streaming services that have been confirmed to be compatible.

Wireless Control from a Tablet or Smartphone (P.62)

The AG-CX350 can be controlled remotely and wirelessly using a tablet/smartphone app*1 (available on the App Store and Google Play for free). In addition to zoom, i.Zoom and focus lens control, the app enables remote control of various other functions, including camera setting, picture quality adjustment, REC start/stop and menu setting. What's more, the app can be used to select the camera to control from up to eight cameras.*2



* Pictures simulated.



CX ROP



*1: iPad: iOS 9 or later are supported. Android devices: Android 5.0 or later are supported. Wireless module (sold separately; [AJ-WM50](#) or [recommended third-party Wi-Fi dongle](#)) is required.
*2: The app does not support simultaneous/synchronous control of multiple cameras. Camera switching takes several seconds.

Parallel Output of SDI and HDMI

SDI and HDMI can be output in parallel. Output of UHD video via HDMI and output of HD video in high-image-quality 10-bit, 4:2:2 via SDI enable a variety of uses. In HLG shooting, either HDR or SDR can be selected for each of the SDI, HDMI and LCD video outputs.







1-1. Available format and record time

	Format	Sampling	File format	Frame rate	Audio	Rec time*
UHD 3840x2160	HEVC Long GOP 200M	4:2:0 10bit	MOV (HEVC)	59.94p, 50p	24 bit LPCM 4ch	40m
	HEVC Long GOP 150M	4:2:0 10bit	MOV (HEVC)	29.97p, 25p, 23.98p		55m
	HEVC Long GOP 100M	4:2:0 10bit	MOV (HEVC)	59.94p, 50p		1h20m
	422ALL-I 400M	4:2:2 10bit	MOV (AVC)	29.97p, 25p, 23.98p		20m
	422LongGOP 150M	4:2:2 10bit	MOV (AVC)	29.97p, 25p, 23.98p		55m
	420LongGOP 150M	4:2:0 8bit	MOV (AVC)	59.94p, 50p		55m
	420LongGOP 100M	4:2:0 8bit	MOV (AVC)	29.97p, 25p, 23.98p		1h20m
FHD (1080p/i, 720p)	AVC-Intra422 (200M)	4:2:2 10bit	MXF (OP1b)	59.94p, 50p	24 bit LPCM 4ch	32m
	AVC-LongG50 (50M, 1080i)	4:2:2 10bit	MXF (OP1b)	59.94i, 50i		2h08m
	AVC-LongG50 (50M, 720p)	4:2:2 10bit	MXF (OP1b)	59.94p, 50p		2h08m
	AVC-LongG25 (50M, 1080p)	4:2:2 10bit	MXF (OP1b)	59.94p, 50p		2h08m
	AVC-LongG25 (25M, 1080i)	4:2:2 10bit	MXF (OP1b)	59.94i, 50i		4h16m
	AVC-LongG25 (25M, 720p)	4:2:2 10bit	MXF (OP1b)	59.94p, 50p		4h16m
	AVC-LongG12 (24M, 1080p)	4:2:0 8bit	MXF (OP1b)	59.94p, 50p	16 bit LPCM 4ch	4h00m
	AVC-LongG12 (12M, 1080i)	4:2:0 8bit	MXF (OP1b)	59.94i, 50i		8h00m
	AVC-LongG12 (12M, 720p)	4:2:0 8bit	MXF (OP1b)	59.94p, 50p		8h00m
FHD (1080p/i)	422ALL-I 200M	4:2:2 10bit	MOV (AVC)	59.94p, 50p	24 bit LPCM 4ch	40m
	422ALL-I 100M	4:2:2 10bit	MOV (AVC)	29.97p, 25p, 23.98p, 59.94i, 50i		1h20m
	422LongGOP 100M	4:2:2 10bit	MOV (AVC)	59.94p, 50p		1h20m
	422LongGOP 50M	4:2:2 10bit	MOV (AVC)	29.97p, 25p, 23.98p, 59.94i, 50i		2h40m
	PS 25Mbps	4:2:0 8bit	AVCHD	59.94p, 50p	Dolby Audio 2ch	5h20m
	PH 21Mbps	4:2:0 8bit	AVCHD	23.98p, 59.94i, 50i		6h00m
	HA 17Mbps	4:2:0 8bit	AVCHD	59.94i, 50i		8h30m
HD	PM 8Mbps	4:2:0 8bit	AVCHD	59.94p, 50p		17h10m
SD	SA 9Mbps	4:2:0 8bit	AVCHD	59.94i, 50i		16h00m

*Record times are approx. with 128GB memory card.

1-2. Applicable memory cards

Applicable type or speed class of memory card varies depends on record format and mode.

Format	Card type	Record bit-rate & record mode	Minimum requirement of speed class		
			Speed class	UHS speed class	Video speed class
MOV		400Mbps	--	--	V60
		FHD VFR(23.98p)/SUPER SLOW ALL-I (Variable frame rate or super slow record mode)			
		200Mbps			
		150Mbps			
		100Mbps			
	 (64GB)	FHD VFR(59.94p, 50.00p, 29.97p, 25.00p), ALL-I Variable Frame Rate record mode)	--	U3	V30
	FHD VFR/SUPER SLOW Long GOP (Variable frame fate or super slow record mode)				
	50Mbps	10	U1	V10	
AVCHD		PS PH HA PM SA	4	--	--
					
					
P2		AVC-Intra422 AVC-LongG	--	--	--

*microP2 is an SD card size memory card designed for Panasonic's professional video cameras and recorders.

2. Preparation before recording

AG-CX350

2-1. Terminals

Image resolution of HDMI and SDI signals vary depend on the system settings.
 See P.82 -83 for the details of output signals.

REAR VIEW



2-2. Accessory and tripod mounting holes

The AG-CX350 has two screw holes for tripod mount, industrial standard **1/4-20UNC** size and cinema/broadcast equipment standard **3/8-16UNC** size.

BOTTOM VIEW (holes for mounting tripod)

Use screws shorter than 5.5mm in length, otherwise damage may occur to internal parts.

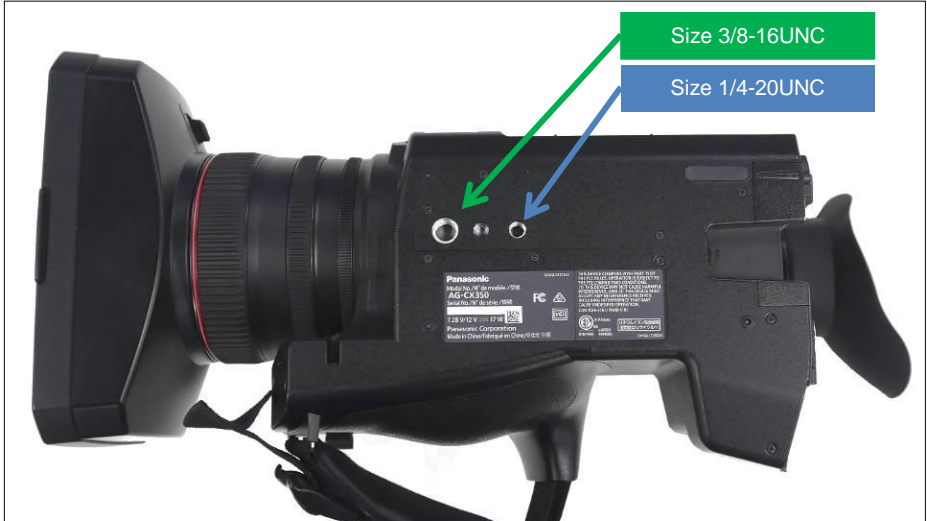

REAR VIEW (holes for mounting an accessory)

Use screws M3 size and shorter than 6.0mm in length, otherwise damage may occur to internal parts.



2-3. Audio setting

The AG-CX350 is equipped with a built-in stereo microphone and two external audio inputs. It also supports 4-channel audio recording.

Setting audio

1. Connect external audio source

Connect microphone or external audio source to the XLR (AUDIO INPUT1, and INPUT2) terminals when record without using built-in microphone.

2. [A] Select audio source with CH1 SELECT, CH2 SELECT switches

Set audio source of CH1 and CH2. Choose "INPUT1" when using audio source connected to INPUT1 XLR terminal. Choose INT (L) or INT (R) when using built-in microphone.

3. [B] Set input level using INPUT1, INPUT2 switches (this selection is not available when INT(L), INT(R) is selected as audio source).

Set audio level for LINE level, Microphone with +48V powered, and Microphone with no +48V powered, using selectors in INPUT1 and INPUT2. Audio levels for LINE and MIC input can also be set in MENU > AUDIO > INPUT SETTINGS.

4. [C] Set record level

Set audio record level using AUDIO LEVEL knob.

(This control is available when following menu item is set to "MANUAL".

MENU > AUDIO > REC CH SETTINGS > CH1 LEVEL / CH2 LEVEL)

Setting Input level
(MENU>AUDIO>INPUT SETTINGS)

Menu item	Setting
INPUT1 LINE LEVEL	4dB, 0dB
INPUT2 LINE LEVEL	4dB, 0dB
INPUT1 MIC LEVEL	-40dB, -50dB, -60dB
INPUT2 MIC LEVEL	-40dB, -50dB, -60dB



[B] [A] [C]

Setting example:

Using a microphone (+48V power required) as INPUT1 source, and assigning built-in microphone as INPUT2 source.

	CH1	CH2
(A) CH SELECT selector	INPUT1	INT(R)
(B) INPUT selector	+48V	Any position(*)

* Does not function when built-in microphone is chosen.

2-4. Recording/outputting 4 channel audio

Audio source for channel 3 and channel 4 are automatically determined and fixed by audio channel settings of CH1 and CH2. See table below for details.

* The 3rd and 4th channels are not available when using any AVCHD codec.



CH1 SELECT	CH2 SELECT	Audio sources to be taken for record/output			
		CH1	CH2	CH3	CH4
INT (L)	INT (R)	Built-in MIC (Left)	Built-in MIC (Right)	AUDIO INPUT1	AUDIO INPUT2
	INPUT1		AUDIO INPUT1		Built-in MIC (Right)
	INPUT2		AUDIO INPUT2		
INPUT1	INT (R)	AUDIO INPUT1	Built-in MIC (Right)	Built-in MIC (Left)	AUDIO INPUT2
	INPUT1		AUDIO INPUT1		Built-in MIC (Right)
	INPUT2		AUDIO INPUT2		
INPUT2	INT (R)	AUDIO INPUT2	Built-in MIC (Right)	Built-in MIC (Left)	AUDIO INPUT2
	INPUT1		AUDIO INPUT1		Built-in MIC (Right)
	INPUT2		AUDIO INPUT2		

Interchangeability of clips

Video clips recorded with 4-channel audio cannot be played back on the AG-CX350 firmware version 1.x.

The "!" icon is shown on the thumbnail screen for all unplayable clips.



NOTE: How to set INPUT MIC LEVEL

MIC level can be set to -40dB, -50dB or -60dB as determined by **MENU > AUDIO > INPUT SETTINGS > INPUT1/2 MIC LEVEL**. Choose the closest value that matches the sensitivity of your microphone. Following is an example using one of Panasonic's microphone i.e. AG-MC200. With this microphone, "-40dB" would be the most suitable Input Mic Level setting to use.

Specifications

Power supply: Phantom power supply, 48 V DC
Current consumption: 2.0 mA (typical)

 indicates safety information.

Type:

Back electret capacitor type microphone

Frequency response:

160 Hz to 20 kHz

Sensitivity:

-40 dB \pm 3.5 dB (0 dB = 1 V/Pa, at 1 kHz)

Maximum Input sound pressure level:

127 dB S.P.L. (at 1 kHz, 1% distortion)

S/N ratio (1 kHz/Pa):

69 dB or more

Output Impedance:

100 Ω \pm 30% (at 1 kHz)

Example: Sensitivity specification of Panasonic AG-MC200 microphone

2-5. User assignable buttons

Features/functions can be quickly recalled, from 12 user assignable buttons (7 physical buttons on the body, and 5 buttons on the touch screen).

	F1:	F2:	F3:	F4:	F5:	F6:
		FLUO.	SPARK	B. STR	CINE	HLG
USER 8	IR REC					
USER 9	FOCUS MACRO					
USER10	AREA					
USER11	ATW LOCK					
USER12	MENU					



Checking functions assigned to USER buttons

Keep pressing "DISP/MODE CHK" button for 1 second, and then press the button 3 times to see.



DISP/MODE CHK button

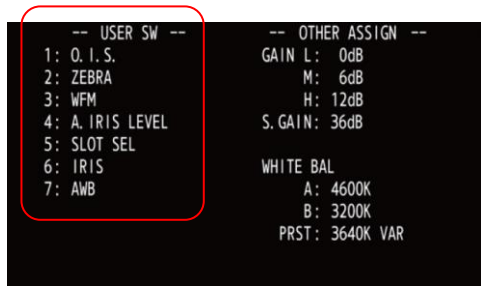

2-5-1. Assigning functions

MENU > CAMERA > USER SW > Assign any function to any button.



2-5-2. Assignable functions

(Ⓞ) : Features that turn OFF when switch off the unit.

Menu item	Description
INHIBIT	The user button is disabled (nothing is assigned)
AWB	Perform the auto white balance adjustment.
DRS	Turn ON/OFF the dynamic range stretcher function. The DRS works to minimize compressed blacks and overexposed highlights
(Ⓞ) FBC	Turn ON/OFF the flash band compensation feature.
ONE PUSH AF	Focus mode becomes AUTO while keep pressing the USER button.
(Ⓞ) S.GAIN	Turn ON/OFF super gain function that allows boosting image gain 24dB or higher.
(Ⓞ) AREA	Turn ON/OFF the AREA mode. This mode allows the camera to set iris and focus by tapping the built-in touch screen.
(Ⓞ) AF AREA	Adjust the size of window where auto focus (AF) is enabled.
ATW	Turn ON/OFF auto tracking white balance.
(Ⓞ) ATW LOCK	Maintain and lock the last white balance achieved by Auto Tracking White (ATW) mode.
(Ⓞ) SPOTLIGHT	Switch auto iris mode to Spotlight mode. The spotlight mode optimizes iris control behavior when the contrast around the subject is high (example: the subject is a spot light etc.)
(Ⓞ) BACKLIGHT	Switch auto iris mode to backlight mode. The backlight mode can prevent underexposure when the main lighting is emanating from behind the subject.

2-5-2. Assignable functions (Continued)

Menu item	Description
A.IRIS LEVEL	Turn ON/OFF auto iris level adjustment mode that allows users to set auto iris target level.
IRIS	Enable/disable auto iris mode.
(Ⓞ) Y GET	Turn ON/OFF the spot meter function.
FOCUS MACRO	Turn ON/OFF the macro mode. With macro mode ON, focus adjustable range at Wide-end is from 10cm to infinity. (With macro mode OFF, from 1m to infinity.)
O.I.S.	Turn ON/OFF the optical image stabilizer.
i.ZOOM	Turn ON/OFF the “i.Zoom” mode that allows the camera to magnify the image (electronically).
(Ⓞ) D.ZOOM	Use Digital Zoom (electronic image magnification) feature. The magnification ratio can be set from x2, x5, x10, or can be toggled through each of them.
IR REC	Turn ON/OFF the Infrared shooting mode.
(Ⓞ) FAST ZOOM	Increase servo zoom speed.
PRE REC	Turn ON/OFF the pre-record mode. This mode allows the camera to start recording video and audio from approx. 3 to 10 sec before the REC/PAUSE button is pressed.
VFR	Enable/disable variable frame rate record function.
SUPER SLOW	Turn ON/OFF super slow record mode.
REC CHECK	Plays last 3 sec of the last recorded clip on the SD memory card.
BACKGR PAUSE	Quit from the Background record mode (P.60)
DEL LAST CLIP	Delete the last clip from the memory card.
SLOT SEL	Switch memory card slots for recording/playing back.
(Ⓞ) EXPAND	Turn ON/OFF image magnification focus assist function.
(Ⓞ) PEAKING	Turn ON/OFF peaking and square focus assist function.
(Ⓞ) WFM	Display the Waveform or Vector scope on the built-in LCD monitor. Set MENU > VIDEO OUT/LCD/VF > EI ASSIST > WFM mode to select the item (Waveform or Vector scope).
ZEBRA	Turn ON/OFF the ZEBRA indicator.
LEVEL GAUGE	Display a level gauge on the viewfinder for the horizontal and vertical axes. Inclinations can be indicated up to approx. 30 degrees in the horizontal, and the vertical directions.
LEVEL GAUGE SET	Set the current angle as level gauge reference.
LCD/VF HDR	Choose image mode to be displayed on the built-in LCD monitor and viewfinder from High dynamic range to standard dynamic range.
(Ⓞ) VF ON/OFF	Turn ON/OFF the EVF display.
LCD/VF DETAIL	Make focusing easier by enhancing the subject's edge on the viewfinder and built-in LCD monitor.
AUDIO MON SEL	Output audio on the CH3 and 4 from AV OUT, phones out, and built-in speaker while keep pressing the USER button.
MENU	Open MENU.
LOAD SETUP FILE	Recall set up file (setting data) from an SD memory card.
LCD BACKLIGHT	Set backlight level of the built-in LCD monitor.
(Ⓞ)CARD READER MODE	Turn ON/OFF card reader mode (USB mass storage mode).
(Ⓞ)STREAMING START	Start/stop video streaming distribution from the AG-CX350.

3. MENU operations

AG-CX350

3-1. MENU items overview

The AG-CX350 has two menu areas :

MENU	Purpose	How to open
MENU	Most of basic and advanced settings can be set in this layer.	Press "MENU" button.
OPTION MENU	Some initial settings	Press "MENU" button while keep pressing "EXIT" button. 

MENU (Press "MENU" button to open)

- CAMERA (Sensitivity, shutter etc.) [P.21]
- SCENE FILE (Image related settings) [P.24]
- AUDIO (Input gain and other audio related settings) [P.33]
- VIDEO OUT/LCD/VF (SDI, HDMI output related settings) [P.35]
- RECORDING (Recording related such as Infrared, TC set) [P.42]
- NETWORK (Video streaming, LAN related settings) [P.44]
- SYSTEM (Fundamental settings such as CODEC etc.) [P.48]
- OTHERS (Saving user files, initializing etc.) [P.49]

OPTION MENU (Press "EXIT" + "MENU" to open)

- AREA SETTINGS (Region related settings) [P.51]

[CAMERA] MENU**3-1-1. SW MODE**

Menu item	Description	Value (Factory default underlined)
LOW GAIN	Set GAIN value when the gain selector is set to "L".	-3dB -- <u>0dB</u> -- +18dB
MID GAIN	Set GAIN value when the gain selector is set to "M".	-3dB -- <u>6dB</u> -- +18dB
HIGH GAIN	Set GAIN value when the gain selector is set to "H".	-3dB -- <u>12dB</u> -- +18dB
SUPER GAIN	Set GAIN value in the SUPER GAIN mode, which is available as one of the user assignable functions.	24dB, 30dB, <u>36dB</u> , ALL * The gain value can be chosen from any of the above or can be toggled through each by selecting "ALL".
O.I.S	Turn ON/OFF optical image stabilizer function.	<u>ON</u> , OFF (USER button assignable)
HYBRID O.I.S	Turn ON/OFF electrical image stabilizer which works in addition to optical one i.e. OIS	<u>ON</u> , OFF
O.I.S MODE	OIS characteristic customization.	<u>NORMAL</u> : PAN/TILT: suitable when camera is used in hand held mode STABLE: suitable when camera mount is stable i.e. on tripod etc.
ATW	Assign Auto Tracking White (ATW) to any position of WHITE BAL selector.	Ach, Bch, PRE, <u>OFF</u>
ATW SPEED	Set response and adjustment speed of ATW function.	FAST, <u>NORMAL</u> , SLOW
ATW TARGET R	Fine-tune the ATW adjustment result (to make it more/less Reddish).	-10 -- <u>0</u> -- 10
ATW TARGET B	Fine-tune the ATW adjustment result (to make it more/less Blueish).	-10 -- <u>0</u> -- 10
W.BAL PRESET	Set white balance mode when WHITE BAL selector is set to PRST.	<u>3200K</u> , 5600K, VAR
H ZOOM SPEED	Increase/decrease service zoom speed with a zoom lever on the carrying handle.	1 -- <u>50</u> -- 99
i.ZOOM	Activate electronic image zoom feature, which can extend zoom ratio while maintaining a image quality.	ON, <u>OFF</u>
MF ASSIST	Focus mode is momentarily set to "AUTO" immediately after manual focusing.	ON, <u>OFF</u>
MACRO	Turn ON/OFF macro mode.	ON, <u>OFF</u> (USER button assignable)

[CAMERA] MENU**3-1-1. SW MODE (Continued)**

Menu item	Description	Value (Factory default underlined)
AF AREA WIDTH	Set the size of window where auto focus is enabled.	ON, <u>OFF</u>
A.IRIS SPEED	Set adjustment speed of auto iris control.	FAST, <u>NORMAL</u> , SLOW
A.IRIS WINDOW	Set the type of window where auto iris is enabled.	<u>NORMAL1</u> : Set a window on the center of screen <u>NORMAL2</u> : Set a window on the upper of screen <u>CENTER</u> : Set a window at the center spot of screen
AREA MODE	Choose the feature that works when tapping the subject on the built-in LCD.	<u>INH</u> , FOCUS, IRIS, YGET, FOCUS/IRIS, FOCUS/YGET INH: No function is assigned. FOCUS: Adjust the focus so that the pointed subject is in focus. IRIS: Adjust the iris so that aperture level is appropriate for the pointed subject. Y GET: Indicate Y level of the pointed subject. FOCUS/IRIS: Adjust both focus and iris for the pointed subject. FOCUS/YGET: Adjust focus and indicate Y level of the pointed subject.
IR REC	Turn ON/OFF the Infrared shooting mode.	ON, <u>OFF</u>

3-1-2. AUTO SW

Set features that enable while the camera is in AUTO mode.

Menu item	Value
A.IRIS	<u>ON</u> , OFF
AGC (Automatic image Gain Control)	<u>ON</u> , OFF
AGC LIMIT (Set the upper limit of the gain while in AUTO mode.)	3dB, <u>6dB</u> , 12dB, 18dB
AGC POINT (Set F-number value to switch aperture control from auto iris to AGC)	<u>F4.0</u> , F5.6
A.SHUTTER (Auto shutter)	<u>ON</u> , OFF
A.SHUTTER LIMIT (Set upper limit of the shutter speed while in AUTO mode.)	1/100, 1/120, <u>1/250</u>
A.SHUTTER POINT (Set F-number value to switch aperture control from auto iris to auto shutter)	<u>F8.0</u> , F9.6
ATW (Auto Tracking White balance)	<u>ON</u> , OFF
AF (Auto focus)	<u>ON</u> , OFF

[CAMERA] MENU

3-1-3. USER SW

Menu item	Default value	Description
USER 1	O.I.S	Features/functions can be quickly recalled from 12 user assignable buttons (7 physical buttons on the body, and 5 buttons on the touch screen). See 2-5. User assignable buttons (P.16) for more details.
USER 2	ZEBRA	
USER 3	WFM	
USER 4	A.IRIS LEVEL	
USER 5	SLOT SEL	
USER 6	IRIS	
USER 7	AWB	
USER 8	IR REC	
USER 9	FOCUS MACRO	
USER 10	AREA	
USER 11	ATW LOCK	
USER 12	MENU	

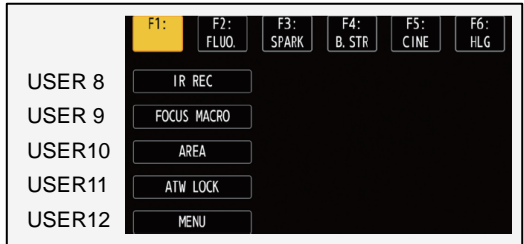

[SCENE FILE] MENU**3-1-4. FILE SELECT**

Menu item	Description	Value (Factory default underlined)	
FILE SELECT	Recall scene file presets	<u>F1</u> :	Basic setting
		F2:FLUO	Suitable for shooting indoors under fluorescent lighting.
		F3:SPARK	Suitable for recording with richer color level and sharper contrast.
		F4:B.STR	Setting enhancing darker scene areas
		F5:CINE	Suitable for movie-like recording
		F6:HLG	Setting for HLG standard recording

* See P.80 for the default settings of each scene file preset.

3-1-5. NAME EDIT

Menu item	Description	Value
NAME EDIT	Create, edit scene file names.	--

3-1-6. LOAD/SAVE/INITIALIZE

Menu item	Description	Value
LOAD/SAVE/INITIALIZE	Load / Save custom scene files to/from onboard memory device in the unit.	LOAD, SAVE, INITIALIZE

3-1-7. VFR

Menu item	Description	Value
VFR	Turn ON/OFF variable frame rate mode.	ON, <u>OFF</u>

3-1-8. FRAME RATE

Menu item	Description	Value
FRAME RATE	Adjust frame rate. Adjustable range is from 1fps to 60fps (50fps)	MENU → SYSTEM → FREQUENCY → 59.94Hz 60, 54, 48, 44, 40, 36, 34, 32, 30, 28, 27, 26, 25, 24, 22, 21, 20, 18, 15, 12, 9, 6, 4, 2, 1fps
		MENU → SYSTEM → FREQUENCY → 50.00Hz 50, 48, 45, 42, 37, 34, 32, 30, 28, 27, 26, 25, 24, 23, 22, 21, 20, 18, 15, 12, 9, 6, 4, 2, 1fps

[SCENE FILE] MENU**3-1-9. SYNC SCAN TYPE**

Menu item	Description	Value (Factory default underlined)
SYNC SCAN TYPE	Select display unit of synchro scan.	<u>sec</u> , deg

3-1-10. SYNC SCAN

Menu item	Description	Value												
SYNC SCAN	Set speed of the variable shutter (synchro scan) which is suitable to film image on display devices.	<table border="1"> <thead> <tr> <th colspan="2">SYSTEM FREQUENCY</th> </tr> <tr> <th></th> <th>50.00Hz</th> </tr> </thead> <tbody> <tr> <td>59.94i: 1/60.0–1/7200</td> <td>50i: 1/50.0 – 1/7200</td> </tr> <tr> <td>59.94p: 1/60.0–1/7200</td> <td>50p: 1/50.0 – 1/7200</td> </tr> <tr> <td>29.97p: 1/30.0–1/7200</td> <td>25p: 1/25.0 – 1/7200</td> </tr> <tr> <td>23.98p: 1/24.0–1/7200</td> <td></td> </tr> </tbody> </table>	SYSTEM FREQUENCY			50.00Hz	59.94i: 1/60.0–1/7200	50i: 1/50.0 – 1/7200	59.94p: 1/60.0–1/7200	50p: 1/50.0 – 1/7200	29.97p: 1/30.0–1/7200	25p: 1/25.0 – 1/7200	23.98p: 1/24.0–1/7200	
		SYSTEM FREQUENCY												
	50.00Hz													
59.94i: 1/60.0–1/7200	50i: 1/50.0 – 1/7200													
59.94p: 1/60.0–1/7200	50p: 1/50.0 – 1/7200													
29.97p: 1/30.0–1/7200	25p: 1/25.0 – 1/7200													
23.98p: 1/24.0–1/7200														
SYNC SCAN deg	3.0d – 360.0d													

Variable range of synchro scan

3-1-11. MASTER DTL

Menu item	Description	Value
MASTER DTL	Adjust image contour correction level for entire image.	-31 – <u>0</u> - 31

3-1-12. DTL CORING

Menu item	Description	Value
DTL CORING	Adjust threshold level of image contour correction.	0 – <u>15</u> - 60

3-1-13. DETAIL SETTING

Menu item	Description	Value
DETAIL	Turn ON/OFF the image contour correction.	<u>ON</u> , OFF
V.DTL LEVEL	Adjust image contour correction level for vertical detail.	-7 – <u>0</u> - 7
DTL FREQ.	Set the thickness of contour correction signal. Image enhancement level becomes higher when value is increased	-7 – <u>0</u> - 7
LEVEL DEPEND.	Set the detail level of low-luminance areas (dark areas).	-7 – <u>0</u> - 7
KNEE APE LVL	Set the detail level of high-luminance areas (very bright areas).	-7 – <u>2</u> - 7
DTL GAIN(+)	Set the detail level in the positive (brightening) direction separately.	-31 – <u>0</u> - 31
DTL GAIN(-)	Set the detail level in the negative (darkening) direction separately.	-31 – <u>0</u> - 31

[SCENE FILE] MENU

3-1-14. SKIN TONE DTL A, B, C

Menu item	Description	Value (Factory default underlined)
SKIN TONE DTL A, B, C	Adjust level of softness effect for a certain color tone (e.g. flesh tone).	ON, <u>OFF</u>

3-1-15. SKIN TONE ZEBRA

Menu item	Description	Value
SKIN TONE ZEBRA	Display ZEBRA pattern on the areas where skin tone detail effect is active.	<u>ON</u> , OFF

3-1-16. SKIN TONE DTL SETTING

Menu item	Description	Value
DETECT TABLE	Select the skin color table of the object to apply the skin tone table to.	<u>A</u> , B, C
SKIN DTL EFFECT	Set skin tone effect level.	0 - <u>16</u> - 31
I CENTER	Set the center position on the I axis (the area to apply Skin Tone).	0 - <u>35</u> - 255
I WIDTH	Set the area width to apply Skin Tone Detail along the I axis with [I CENTER] as the center.	1 - <u>2</u> - 3
Q WIDTH	Set the area width to apply Skin Tone Detail along the Q axis with [I CENTER] as the center.	1 - <u>2</u> - 3
Q PHASE	Set the area phase to apply Skin Tone Detail with the Q axis as a reference.	-128 - <u>0</u> - 127

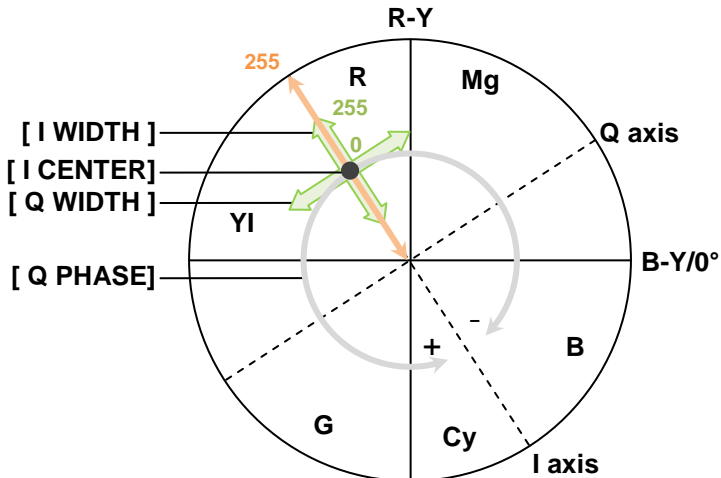

[SCENE FILE] MENU**3-1-17. RB GAIN CONTROL SETTING**

Menu item	Description	Value (Factory default underlined)
R GAIN AWB PRE	Set Red-ch gain when WHITE BAL selector is set to PRST.	-200 - <u>0</u> - 200
B GAIN AWB PRE	Set Blue-ch gain when WHITE BAL selector is set to PRST.	-200 - <u>0</u> - 200
R GAIN AWB A	Set Red-ch gain when WHITE BAL selector is set to A.	-200 - <u>0</u> - 200
B GAIN AWB A	Set Blue-ch gain when WHITE BAL selector is set to A.	-200 - <u>0</u> - 200
R GAIN AWB B	Set Red-ch gain when WHITE BAL selector is set to B.	-200 - <u>0</u> - 200
B GAIN AWB B	Set Blue-ch gain when WHITE BAL selector is set to B.	-200 - <u>0</u> - 200
AWB A GAIN OFFSET	Determine whether to apply R and B GAIN AWB A offset control after AWB is performed while WHITE BAL selector is set to A.	ON: Apply <u>OFF</u> : Not apply
AWB B GAIN OFFSET	Determine whether to apply R and B GAIN AWB B offset control after AWB is performed while WHITE BAL selector is set to B.	ON: Apply <u>OFF</u> : Not apply

3-1-18. COLOR TEMP Ach SETTING

Menu item	Description	Value
COLOR TEMP	Set color balance when WHITE BAL selector is set to "PRST". When the selector is set to "A", recent AWB adjustment result is displayed here.	2000K - <u>3200K</u> - 15000K
R GAIN	Set level of R channel when WHITE BAL selector is set to "PRST". When the selector is set to "A", recent level as AWB adjustment result is displayed here.	-400 - <u>0</u> - 400
B GAIN	Set level of B channel when WHITE BAL selector is set to "PRST". When the selector is set to "A", recent level as AWB adjustment result is displayed here.	-400 - <u>0</u> - 400
G AXIS	Set level of G channel when WHITE BAL selector is set to "PRST". When the selector is set to "A", recent level as AWB adjustment result is displayed here.	-400 - <u>0</u> - 400

[SCENE FILE] MENU**3-1-19. COLOR TEMP Bch SETTING**

Menu item	Description	Value (Factory default underlined)
COLOR TEMP	Set color balance when WHITE BAL selector is set to "PRST". When the selector is set to "B", recent AWB adjustment result is displayed here.	2000K – <u>3200K</u> - 15000K
R GAIN	Set level of R channel when WHITE BAL selector is set to "PRST". When the selector is set to "B", recent level as AWB adjustment result is displayed here.	-400 – <u>0</u> - 400
B GAIN	Set level of B channel when WHITE BAL selector is set to "PRST". When the selector is set to "B", recent level as AWB adjustment result is displayed here.	-400 – <u>0</u> - 400
G AXIS	Set level of G channel when WHITE BAL selector is set to "PRST". When the selector is set to "B", recent level as AWB adjustment result is displayed here.	-400 – <u>0</u> - 400

3-1-20. CHROMA LEVEL

Menu item	Description	Value
CHROMA LEVEL	Set color level.	OFF, -99% - <u>0</u> - 99%

3-1-21. CHROMA PHASE

Menu item	Description	Value
CHROMA PHASE	Set color phase	-31 – <u>0</u> - 31

3-1-22. MATRIX

Menu item	Description	Value
MATRIX TYPE	Set color preset table.	<u>NORMAL1</u> : Basic setting NORMAL2: More vivid color than NORMAL1 FLUO: Suitable when fluorescent lighting is used as the predominant light source (example: shooting indoors). CINELIKE: Suitable for achieving movie-like image characteristics
ADAPTIVE MATRIX	Setting to reduce color distortion under strong blue LED lighting.	ON, <u>OFF</u>

[SCENE FILE] MENU**3-1-23. MATRIX SETTING**

Menu item	Description	Value (Factory default underlined>)
R-G	Adjust linear matrix for each color axis.	-63 - <u>0</u> - 63
R-B		
G-R		
G-B		
B-R		
B-G		

Concept of MARIX control:

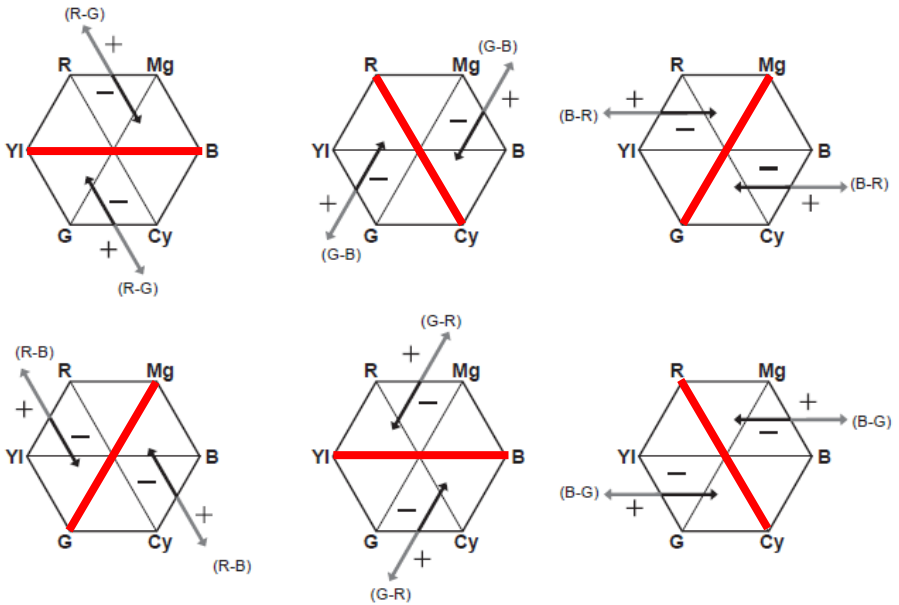

— The axis that is not affected for each matrix setting menu item

[SCENE FILE] MENU**3-1-24. COLOR CORRECTION**

Menu item	Description	Value (Factory default <u>underlined</u>)
COLOR CORRECTION	Adjust color tone and saturation. This has an effect on 16 different individual color phases.	-63 - <u>0</u> - 63

Concept of color correction

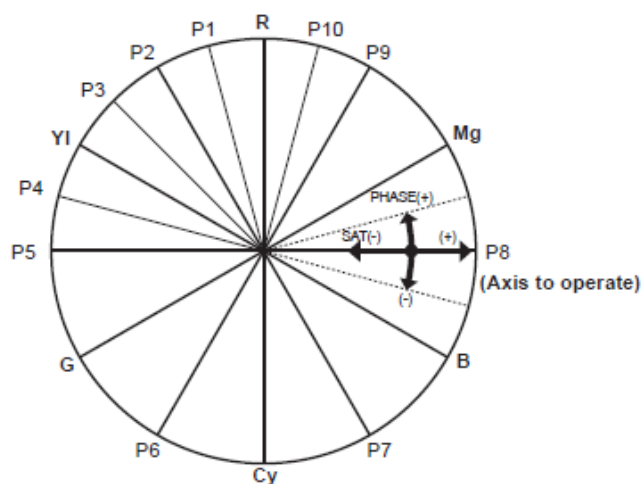

- R: Red
- P1: (Yl-R)-R
- P2: (Yl-R)
- P3: Yl-(Yl-R)
- Yl: Yellow
- P4: (G-Yl)-Yl
- P5: (G-Yl)
- G: Green
- P6: (Cy-G)
- Cy: Cyan
- P7: (B-Cy)
- B: Blue
- P8: (Mg-B)
- Mg: Magenta
- P9: (R-Mg)
- P10: R-(R-Mg)

[SCENE FILE] MENU**3-1-25. MASTER PED**

Menu item	Description	Value (Factory default underlined)
MASTER PED	Adjust master black level	-200 – <u>16</u> - 200

3-1-26. RGB BLACK CONTROL SETTING

Menu item	Description	Value
R PED	Adjust master level of Red channel	-100 – <u>0</u> - 100
G PED	Adjust master level of Green channel	-100 – <u>0</u> - 100
B PED	Adjust master level of Blue channel	-100 – <u>0</u> - 100
PEDESTAL OFFSET	Determine whether to apply adjustment result of R , G and B PED controls as pedestal level offset after Auto Black Balance (ABB) is performed.	ON: Apply OFF: Not applied (pedestal levels of R,G,B PED become zero)

3-1-27. GAMMA MODE SEL

Menu item	Description	Value
GAMMA MODE SEL	Choose image contrast and gradation according to the scene.	HD, SD, FILMLIKE1, FILMLIKE2, FILMLIKE3, FILM-REC, VIDEO-REC, HLG See P.76 for details on how each gamma mode effects the overall look of the image

3-1-28. GAMMA SETTING

Menu item	Description	Value
MASTER GAMMA	Adjust gamma characteristic in units of 0.01.	0.30 – <u>0.45</u> - 0.75
F-REC DYNAMIC LVL	Set dynamic range when FILM-REC item in GAMMA MODE SEL is selected.	200% - <u>600%</u> (in units of 100%)
F-REC BLACK STR LVL	Set black stretch level when FILM-REC item in GAMMA MODE SEL is selected.	<u>0%</u> - 30%
V-REC KNEE SLOPE	Adjusts slope angle when in VIDEO-REC mode.	150% - <u>500%</u> (in units of 50%)
V-REC KNEE POINT	Sets the signal level where video image compression starts to be applied in VIDEO-REC mode.	<u>30%</u> - 107%
BLACK GAMMA	Adjusts gamma characteristics in darker signal areas. (lifts darker areas when value is increased)	-8 – <u>0</u> – 8
B.GAMMA RANGE	Set upper limit of signal compression/expansion for BLACK GAMMA item.	1: Approx. 20% 2: Approx. 30% 3: Approx. 40%

[SCENE FILE] MENU**3-1-29. KNEE SETTING**

Menu item	Description	Value (Factory default underlined)
KNEE MODE	Sets operation mode of knee function (compress bright areas to avoid overexposure in image).	<u>AUTO</u> , MANUAL, OFF
A.KNEE RESPONSE	Sets the response speed. A smaller setting value allows a faster response speed.	1 - <u>4</u> - 8
KNEE POINT	Sets the position of Knee Point in units of 0.5%. *Enabled when KNEE MODE is MANUAL.	70.0% - <u>93.0%</u> - 107.0%
KNEE SLOPE	Sets the slope of Knee. *Enabled when KNEE MODE is MANUAL.	0 - <u>99</u>
HLG KNEE SW	Set ON/OFF of knee mode in HLG mode.	ON, <u>OFF</u>
HLG KNEE POINT	Sets the position of Knee point in HLG mode.	<u>55</u> - 100
HLG KNEE SLOPE	Sets the slope of Knee in HLG mode.	0 - <u>10</u> - 100

3-1-30. WHITE CLIP SETTING

Menu item	Description	Value
WHITE CLIP	Turn ON/OFF white clip function.	<u>ON</u> , OFF
WHITE CLIP LEVEL	Sets the level of white clip in units of 1%.	90% - <u>109%</u>

3-1-31. DRS (Dynamic Range Stretcher)

Compressing the video signal level of high-brightness area, which would normally result in blown-out highlights.

Menu item	Description	Value
DRS	Enables / disables the Dynamic Range Stretcher function	ON, <u>OFF</u> (USER button assignable)

3-1-32. DRS EFFECT DEPTH

Menu item	Description	Value
DRS EFFECT DEPTH	Sets the level of high-brightness area compression applied by the Dynamic Range Stretcher function.	<u>1</u> , 2, 3

3-1-33. DNR

Menu item	Description	Value
DNR	Sets the amount of applied Digital Noise Reduction	OFF, <u>1</u> , 2

3-1-34. A.IRIS LEVEL

Menu item	Description	Value
A.IRIS LEVEL	Turn ON/OFF auto iris level feature.	<u>ON</u> , OFF (USER button assignable)

3-1-35. A.IRIS LEVEL EFFECT

Menu item	Description	Value
A.IRIS LEVEL EFFECT	Sets the target brightness level in auto iris mode.	-50 - <u>0</u> - 50

[AUDIO] MENU**3-1-36. INPUT SETTINGS**

Menu item	Description	Value (Factory default underlined)
INPUT1 MIC LEVEL	Set audio level of audio channel 1. (MIC level)	-40dB, <u>-50dB</u> , -60dB
INPUT2 MIC LEVEL	Set audio level of audio channel 2. (MIC level)	-40dB, <u>-50dB</u> , -60dB
INPUT1 LINE LEVEL	Set audio level of audio channel 1. (LINE level)	4dB, <u>0dB</u>
INPUT2 LINE LEVEL	Set audio level of audio channel 2. (LINE level)	4dB, <u>0dB</u>

3-1-37. REC CH SETTINGS

Menu item	Description	Value
CH1 LEVEL	Set audio level adjustment mode for audio channel1.	<u>AUTO</u> , MANUAL
CH2 LEVEL	Set audio level adjustment mode for audio channel2.	<u>AUTO</u> , MANUAL
CH3 LEVEL	Set audio level adjustment mode for audio channel3.	<u>AUTO</u> , MANUAL
CH4 LEVEL	Set audio level adjustment mode for audio channel4.	<u>AUTO</u> , MANUAL
CH3 LEVEL CONTROL	Adjusts record audio level of audio channel 3 when CH X LEVEL item is MANUAL.	0 - <u>70</u> - 100
CH4 LEVEL CONTROL	Adjusts record audio level of audio channel 4 when CH X LEVEL item is MANUAL.	0 - <u>70</u> - 100
CH1 MIC LOWCUT	Reduce the level of low frequency sound on audio channel 1.	ON, <u>OFF</u>
CH2 MIC LOWCUT	Reduce the level of low frequency sound on audio channel 2.	ON, <u>OFF</u>
CH3 MIC LOWCUT	Reduce the level of low frequency sound on audio channel 3.	ON, <u>OFF</u>
CH4 MIC LOWCUT	Reduce the level of low frequency sound on audio channel 4.	ON, <u>OFF</u>
CH1 LIMITER	Use level control (LIMITER) on audio channel 1. When CH X LEVEL item is MANUAL.	ON, <u>OFF</u>
CH2 LIMITER	Use level control (LIMITER) on audio channel 2. When CH X LEVEL item is MANUAL.	ON, <u>OFF</u>
CH3 LIMITER	Use level control (LIMITER) on audio channel 3. When CH X LEVEL item is MANUAL.	ON, <u>OFF</u>
CH4 LIMITER	Use level control (LIMITER) on audio channel 4. When CH X LEVEL item is MANUAL.	ON, <u>OFF</u>
HEAD ROOM	Choose audio reference level.	12dB, 18dB, <u>20dB</u>

[AUDIO] MENU**3-1-38. OUTPUT SETTINGS**

Menu item	Description	Value (Factory default underlined)
AUDIO OUT	Set monitor audio output channel of phones out, AV OUT, and built-in loudspeaker.	CH1, CH2, CH3, CH4, <u>CH1/2 STEREO</u> , CH1/2 MIX, CH3/4 STEREO, CH3/4 MIX

3-1-39. ALARM

Menu item	Description	Value
BATTERY END	Set alert sound level for battery end alarm	HIGH, MED, LOW, <u>OFF</u>
MEDIA END	Set alert sound level for card near-end alarm	HIGH, MED, LOW, <u>OFF</u>
WARNING	Set alert level for system error and other warnings.	HIGH, MED, LOW, <u>OFF</u>

[VIDEO OUT/LCD/VF] MENU

3-1-40. VIDEO OUT SEL

Menu item	Description	Value (Factory default underlined)
VIDEO OUT SEL	Set signals for video and audio output terminals.	<u>SDI+HDMI</u> , AV+HDMI

3-1-41. SDI OUT

Menu item	Description	Value
OUTPUT SW	Turn ON/OFF SDI signal output.	<u>ON</u> , OFF
OUT FORMAT	Set output signal format on the SDI OUT. Selectable format types vary depends on other system settings. See 6-3. Output signals (SDI) (P.82) for details.	1920x1080p, <u>1920x1080i</u> , 1920x1080PsF, 1280x720p, 720x480i, 720x576i
3G-SDI OUT	Set 3G SDI output type.	LEVEL-A, <u>LEVEL-B</u>
SD-SDI EDH	Determine whether to add EDH signal on the SDI OUT signal in 480i or 576i system mode.	<u>ON</u> , OFF
SDI REC REMOTE	Enable recording remote via SDI terminal.	ON, <u>OFF</u>
SDI OUT CHAR	Show characters on the SDI OUT.	ON, <u>OFF</u>
SDI OUT ZEBRA	Show ZEBRA patterns on the SDI OUT.	ON, <u>OFF</u>
SDI OUT HDR	Set output image on the SDI OUT.	SDR, <u>HDR (*1)</u>

*1 Fixed to "SDR" under following menu conditions.

MENU > SYSTEM > REC FORMAT > 480-59.94i/AVCHD SA

MENU > SYSTEM > REC FORMAT > 576-50.00i/AVCHD SA

MENU > VIDEO OUT/LCD/VF > SDI OUT > OUT FORMAT > 720x480i

MENU > VIDEO OUT/LCD/VF > SDI OUT > OUT FORMAT > 720x576i

SDI OUT HDR setting is fixed to "SDR" when **MENU > SCENE FILE > GAMMA MODE SEL** item is set to anything other than **HLG**.

[VIDEO OUT/LCD/VF] MENU**3-1-42. HDMI OUT**

Menu item	Description	Value (Factory default underlined)
OUT FORMAT	Set output signal format on the HDMI OUT. Selectable format types vary and depends on other system settings. See 6-4. Output signals (HDMI) (P.83) for details.	3840x2160, 3840x2160p (420/8bit), <u>1920x1080p</u> , 1920x1080i, 1280x720p, 720x480p, 720x576p
HDMI TC OUT	Choose whether to superimpose timecode on the HDMI OUT signal.	ON, <u>OFF</u>
HDMI REC REMOTE (*2)	Enable recording remote via HDMI terminal.	ON, <u>OFF</u>
HDMI CHAR	Show characters on the HDMI OUT.	ON, <u>OFF</u>
HDMI OUT ZEBRA	Show ZEBRA patterns on the HDMI OUT.	ON, <u>OFF</u>
HDMI OUT HDR	Set output image on the HDMI OUT.	SDR, <u>HDR (*3)</u>

*2 Enabled while HDMI TC OUT item is set to ON, and disabled while **MENU > RECORDING > REC FUNCTION > REC MODE** is set to **INTERVAL**.

*3 Fixed to "SDR" under following menu conditions.

MENU > SYSTEM > REC FORMAT > 480-59.94i/AVCHD SA

MENU > SYSTEM > REC FORMAT > 576-50.00i/AVCHD SA

MENU > VIDEO OUT/LCD/VF > HDMI OUT > OUT FORMAT > 720x480i

MENU > VIDEO OUT/LCD/VF > HDMI OUT > OUT FORMAT > 720x576i

Output image is fixed to "SDR" while MENU > SCENE FILE > GAMMA MODE SEL item is set to anything other than HLG.

3-1-43. AV OUT

Available while **MENU > VIDEO OUT/LCD/VF > VIDEO OUT SEL** item is set to "**AV+HDMI**".

Menu item	Description	Value
OUTPUT SW	Turn ON/OFF AV signal output.	<u>ON</u> , OFF
AV OUT CHAR	Show characters on the AV OUT.	<u>ON</u> , OFF
AV OUT ZEBRA	Show ZEBRA patterns on the AV OUT.	ON, <u>OFF</u>

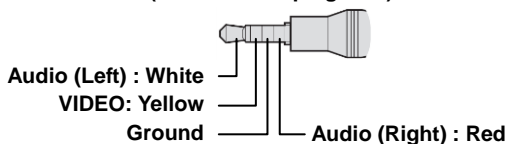
Pin assignment of the AV OUT (described as plug side)

[VIDEO OUT/LCD/VF] MENU**3-1-44. SD DOWNCON MODE**

Menu item	Description	Value (Factory default underlined)
SD DOWNCON MODE	Set the display mode of a down converted image.	SIDE CROP, <u>LETTER BOX</u> , SQUEEZE

3-1-45. LCD

Menu item	Description	Value
BRIGHTNESS	Adjust brightness of the built-in LCD monitor.	-15 - <u>0</u> - 15
COLOR LEVEL	Adjust color level of the built-in LCD monitor.	-15 - <u>0</u> - 15
CONTRAST	Adjust contrast of the built-in LCD monitor.	-30 - <u>0</u> - 30
BACK LIGHT	Adjust brightness of the backlight in the built-in LCD monitor.	-1, <u>0</u> , 1, 2
SELF SHOOT	Set display mode of the built-in LCD monitor. Choose "MIRROR" when performing self-portrait recording. (Image can be inverted horizontally.)	NORMAL, <u>MIRROR</u>

3-1-46. VF

Menu item	Description	Value
BRIGHTNESS	Adjust brightness of the viewfinder.	-15 - <u>0</u> - 15
COLOR LEVEL	Adjust color level of the viewfinder.	-15 - <u>0</u> - 15
CONTRAST	Adjust contrast of the viewfinder.	-30 - <u>0</u> - 30
VF COLOR	Turn OFF color image display on the Viewfinder.	<u>ON</u> , OFF
EYE SENSOR	Set sensitivity of the proximity sensor on the viewfinder.	<u>HIGH</u> , LOW

3-1-47. LCD/VF HDR

Menu item	Description	Value
LCD/VF HDR	Set output image on the built-in LCD monitor and viewfinder.	SDR, <u>HDR</u> (*4)

*4 Fixed to "SDR" under following menu conditions.

MENU > SYSTEM > REC FORMAT > 480-59.94i/AVCHD SA

MENU > SYSTEM > REC FORMAT > 576-50.00i/AVCHD SA

Output image is fixed to "SDR" while **MENU > SCENE FILE > GAMMA MODE SEL** item is set to other than **HLG**.

[VIDEO OUT/LCD/VF] MENU

3-1-48. INDICATOR

Camera status information to be shown on the LCD and viewfinder image can be set individually.

No.	Menu item	Description	Value
2	FRAME RATE	Frame rate in FPS	<u>ON</u> , OFF
3	FULL AUTO	Status while "AUTO/MANUAL" switch on the camera body is set to AUTO.	<u>ON</u> , OFF
5,8	CARD SLOT STATUS	Status of card slots, and remaining time	<u>ON</u> , OFF
7	REMOTE RECORD	Status of record start/stop of the external recorder connected to SDI OUT and HDMI OUT.	<u>ON</u> , OFF
10	RECORD MODE	Status of interval (time laps) record mode.	<u>ON</u> , OFF
11	DUAL SLOT STATUS	Status of Dual slot features (MENU > RECORDING > 2 SLOTS FUNC)	<u>ON</u> , OFF
12	FBC	Status of flash band compensation function.	<u>ON</u> , OFF
13	STREAMING	Status of video streaming.	<u>ON</u> , OFF
14	HDR/DRS	Status of HDR (High Dynamic Range) mode or DRS (Dynamic Range Stretcher mode).	<u>ON</u> , OFF
15	NETWORK	Connection status of wired LAN or Wi-Fi.	<u>ON</u> , OFF
16	BATTERY REMAIN	Battery remaining time	<u>ON</u> , OFF
17	AUDIO LEVEL	Audio level meter	<u>ON</u> , OFF
19	GAIN	Current gain value	<u>ON</u> , OFF
20	ND FILTER	ND filter position.	<u>ON</u> , OFF

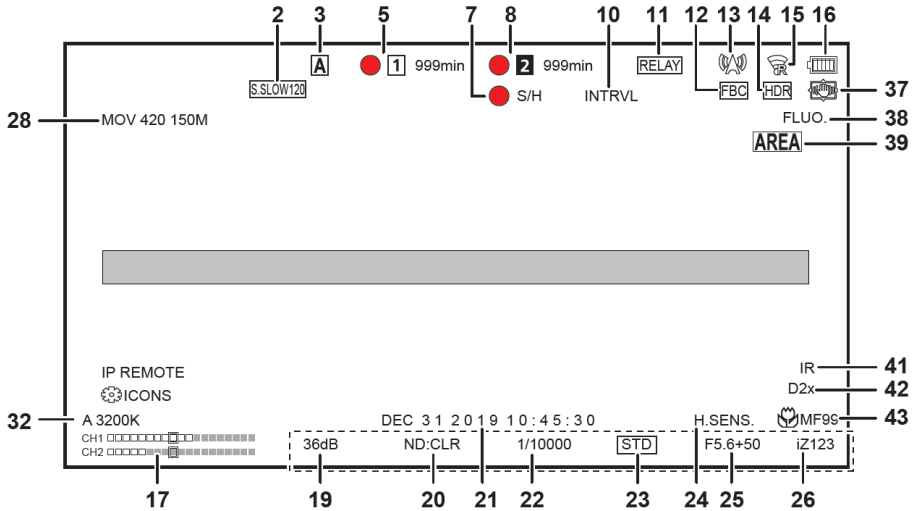

[VIDEO OUT/LCD/VF] MENU

3-1-48. INDICATOR (Continued)



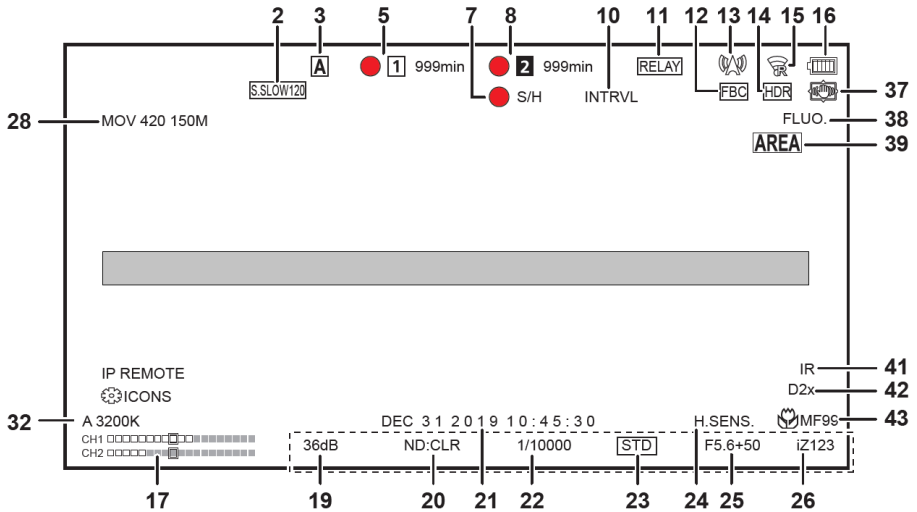

Camera status information to be shown on the LCD and viewfinder image can be set individually.

No.	Menu item	Description	Value
21	DATE/TIME	Current date and time	OFF, DATE, TIME, DATE/TIME
22	SHUTTER	Current shutter speed.	ON, OFF
23,25	IRIS	Current F-number and auto iris control mode.	ON, OFF
24	CAMERA MODE	Status of HIGH SENSITIVITY mode.	ON, OFF
28	REC FORMAT	Record format	ON, OFF
32	WHITE BALANCE	Current white balance mode.	ON, OFF
37	O.I.S	Status of Optical Image Stabilizer function.	ON, OFF
38	SCENE FILE	Current scene file selected	ON, OFF
39	AREA	Status of AREA MODE control feature.	ON, OFF
41	INFRARED MODE	Status of Infrared record mode. (MENU > CAMERA > SW MODE > IR REC)	ON, OFF
42	DIGITAL ZOOM	Magnification ratio of digital zoom	ON, OFF
26,43	ZOOM/FOCUS	Zoom and Focus position	Number, mm/feet, mm/m, OFF



[VIDEO OUT/LCD/VF] MENU**3-1-49. MARKER**

Marker characters to be shown on the LCD and Viewfinder image can be set individually.

Menu item	Description	Value (Factory default underlined)
CENTER MARKER	Set shape of center marker	<div style="display: flex; justify-content: space-around;"> <div style="text-align: center;"> <p>1</p>  </div> <div style="text-align: center;"> <p>2</p>  </div> </div> <div style="display: flex; justify-content: space-around; margin-top: 10px;"> <div style="text-align: center;"> <p>3</p>  </div> <div style="text-align: center;"> <p>4</p>  </div> </div>
SAFETY MARKER	Set the type of safety zone marker.	1:Boxed, <u>2:Corner only</u> , OFF
SAFETY AREA	Set the size of safety zone marker.	80% - <u>90%</u> - 100%
FRAME MARKER	Set the type of frame marker.	4:3, 13:9, 14:9, 1.85:1, 2.35:1, <u>OFF</u>
FRAME COLOR	Set the color of frame marker.	<u>WHITE</u> , BLACK, RED, GREEN, BLUE, YELLOW

3-1-50. FOCUS ASSIST

Menu item	Description	Value
FOCUS ASSIST SW	Set focus assist mode when FOCUS ASSIST button is pressed.	<u>EXPAND</u> , PEAKING
EXPAND MODE	Set image expanding mode.	<u>10SEC</u> : Expand for 10 seconds HOLD: Keep expanded until the button pressed. UNTIL REC: Expand until recording starts
EXPAND VALUE	Set image magnifying size.	<u>x2</u> , x3, x4
PEAKING LEVEL	Set highlighting level of peaking focus assist.	LOW, <u>MID</u> , HIGH
PEAKING COLOR	Set highlighting color of peaking focus assist.	<u>RED</u> , GREEN, WHITE
BLACK&WHITE	Turn ON/OFF monochrome focus assist function.	ON, <u>OFF</u> , DURING PEAKING: Remove color from the image while peaking/square focus assist function is enabled.
DETAIL	Turn ON edge enhancement feature on the viewfinder and the built-in LCD monitor for easy focusing.	<u>ON</u> , OFF
DETAIL LEVEL	Set enhancement level of the EVF/LCD DETAIL setting.	-3 -- <u>0</u> -- 3
DETAIL FREQ.	Set enhancement frequency of the EVF/LCD DETAIL setting.	HIGH / <u>LOW</u>

[VIDEO OUT/LCD/VF] MENU

3-1-51. EI ASSIST

Settings of Exposure index control related.

Menu item	Description	Value (Factory default underlined)
ZEBRA	Turn ON/OFF the zebra indicator on the LCD image.	ON, <u>OFF</u>
ZEBRA1 DETECT	Set the zebra pattern1. (Right downward)	0% -- <u>80%</u> -- 109%
ZEBRA2 DETECT	Set the zebra pattern2. (Right upward)	0% -- <u>100%</u> -- 109%
ZEBRA2	Set the type of light indication. See figure below for details.	ON, SPOT, <u>OFF</u>
WFM MODE	Display waveform monitor or vector scope. (User button assignable)	<u>WAVE</u> : Display Waveform monitor (WFM) VECTOR: Display vector scope (VSC) WAVE/VECTOR: Show WFM and VSC alternately by pressing an USER button assigned the function.
WFM TRANSPARENT	Set transparency level of WFM/VSC display.	0%, <u>25%</u> , 50%
LEVEL GAUGE	Turn ON/OFF the level gauge function.	<u>ON</u> , OFF
LEVEL GAUGE RESET	Set the current horizontal and vertical position as the reference point for the level gauge.	YES, NO

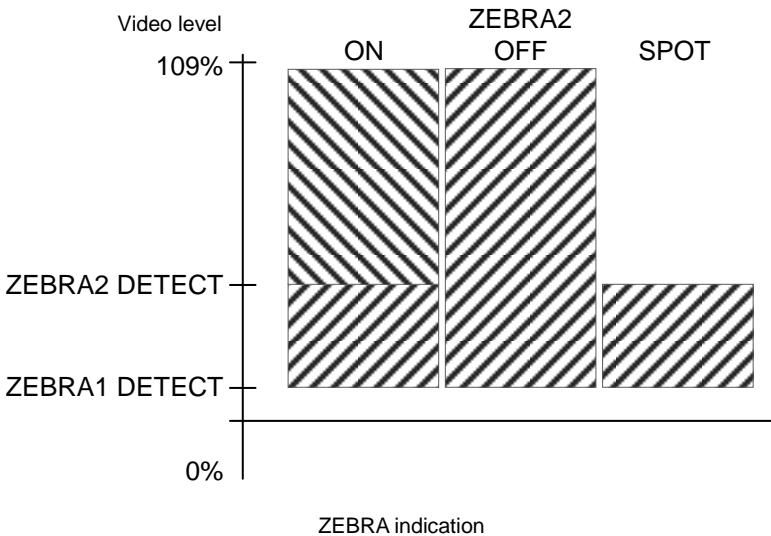

[RECORDING] MENU

3-1-52. FORMAT MEDIA

Menu item	Description	Value (Factory default underlined)
FORMAT MEDIA	Perform memory card format.	SLOT1, <u>SLOT2</u>

3-1-53. CLIP NAME

Menu item	Description	Value
CAM INDEX	Set the camera ID code, to be recorded as the initial letter of the clip name in MOV format.	<u>A</u> - Z
NEXT CARD COUNT	Set the incremental reel number, to be recorded (second to fourth letter of the clip name in MOV format).	<u>001</u> - 999

3-1-54. FILE SPLIT

Menu item	Description	Value
FILE SPLIT	Set file record style with P2 format. Clips are divided every 4GB. (*) Enabled while MENU > SYSTEM > FILE FORMAT item is set to P2.	ONE FILE, <u>SPLIT</u>

*Files are always split when recording with 32GB or smaller memory cards.

3-1-55. 2SLOT FUNC

Menu item	Description	Value
2SLOT FUNC.	Set the record mode when using two SD memory cards. See P.60 for details.	OFF, <u>RELAY REC</u> , SIMUL REC, BACKGR REC

3-1-56. PRE REC

Menu item	Description	Value
PRE REC	Turn ON/OFF the pre-record mode. It allows the camera to capture and record video/audio for a few seconds before REC is started.	ON, <u>OFF</u>

3-1-57. REC FUNCTION

Menu item	Description	Value
REC MODE	Set the record mode.	<u>NORMAL</u> , INTERVAL
REC MODE HOLD	Turn ON to maintain interval rec mode after power OFF.	ON, <u>OFF</u>
INTERVAL TIME	Set the interval time for interval record mode.	1s, 2s, 5s, 10s, 30s, 1min, <u>5min</u> , 10min

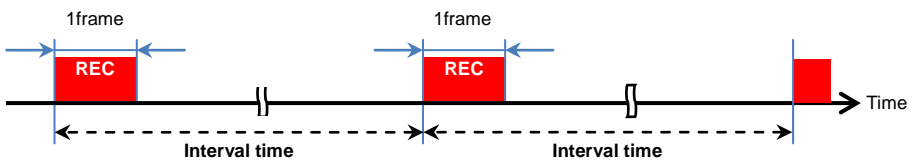

Interval record

[RECORDING] MENU**3-1-58. TC/UB**

Menu item	Description	Value (Factory default underlined)
TC PRESET	Set the timecode value.	---
UB PRESET	Set the users bit information.	<u>00</u> – FF
FREE/REC RUN	Set the timecode count mode (*1)	FREE RUN, <u>REC RUN</u>
DF/NDF	Set the timecode drop frame mode.	<u>DF</u> , NDF
UB MODE	Set information type, to be recorded and output from SDI OUT.	FRAME RATE Frame rate information <u>USER</u> Information, set on SET UB menu item TIME Hour, Minute, Second information DATE Year, Month, Day information CLIP NAME Clip name information
TC IN/OUT SEL	Set purpose of TC IN/OUT terminal.	TC IN: Use as TC input terminal TC OUT: Use as TC output terminal
TC OUT REF	Make value offset for the output timecode.	<u>RECORDING</u> Output timecode without delay. SDI OUT Output timecode with delay so that the value meets timing with SDI OUT image.

*1 Notes about the Timecode count mode

Fixed to "REC RUN" while the following menu items are set as follows.

- MENU > SCENE FILE > VFR > ON
- MENU > SYSTEM > SUPER SLOW > ON
- MENU > RECORDING > REC FUNCTION > REC MODE > INTERVAL

Fixed to "FREE RUN" while the following menu items are set as follows.

- MENU > RECORDING > PRE REC > ON
- MENU > RECORDING > 2SLOT FUNC. > BACKGR REC (Background record mode)

3-1-59. REC COUNTER

Menu item	Description	Value
REC COUNTER	Set the counting method of record counter.	<u>TOTAL</u> : Cumulate until RESET button is pressed CLIP: Reset to zero at the start of every clip recording

3-1-60. TIME STAMP

Menu item	Description	Value
TIME STAMP	Allows recording of superimposed date and time on the image.	<u>OFF</u> , DATE, TIME, DATE&TIME

[NETWORK] MENU**3-1-61. DEVICE SEL**

Menu item	Description	Value (Factory default underlined)
DEVICE SEL	Enable network connection mode.	LAN, WLAN, <u>OFF</u>

3-1-62. NETWORK FUNC

Menu item	Description	Value
NETWORK FUNC	Set network mode.	STREAMING, NDI HX, <u>OFF</u>

3-1-63. IP REMOTE

Menu item	Description	Value
IP REMOTE	Allows operation from the CX ROP tablet/smartphone app.	ENABLE, <u>DISABLE</u>
USER ACCOUNT	Edit/update the user account information for tablet/smartphone apps.	ADD, DELETE
ACCOUNT LIST	Show and/or delete registered accounts in the camera.	---

3-1-64. STREAMING

Menu item	Description	Value
STREAMING FORMAT	Set video format to be used for video streaming over IP network.	See P.84 6-5. Streaming format (Protocol RTMP) for the details.
START TRIGGER	Select start trigger style as "Perform from AG-CX350" or "wait for a trigger from external application".	CAMERA, <u>RECEIVER</u> , RECEIVER (MULTICAST)
CONNECTION INFO.	Set an information reference of the destination server.	<u>MEMORY</u> : Refer setup information from camera's menu settings SD CARD: Refer to setup information from SD card
DATA TYPE	Show type of current network connection. (This is to show information only, not a setting.)	GENERAL: Shown when not connected to P2CAST. P2CAST: Shown when connected to P2Cast file management service.
RECEIVER URL	Set URL of the streaming server (within 511 characters) rtmp:// [server URL] : [Port#] / [path] / [streamkey] rtmps:// [server URL] : [Port#] / [path] / [streamkey]	
MULTICAST ADDRESS	Set IP address for multicast streaming.	Factory default 239.192.0.20
MULTICAST PORT	Set port number for multicast streaming.	Factory default 37004
LOAD (SD CARD)	Recall network settings from an SD card.	YES, NO
SAVE (SD CARD)	Encrypt network settings and store to an SD card.	YES, NO
CLEAR (MEMORY)	Clear streaming related settings in the unit.	ON, <u>OFF</u>
START	Start streaming	ON, <u>OFF</u>

[NETWORK] MENU**3-1-65. NDI|HX**

Menu item	Description	Value (Factory default underlined)
ACTIVATION	Show NDI HX activation status.	--: NDI HX is not activated NDI HX: NDI HX is activated
STREAMING FORMAT	Set video format to be used for video streaming over NDI HX network.	See P.85 (6-6. Streaming format (Protocol NDI HX)) for details.
MULTICAST	Turn ON/OFF multicast communication protocol.	ENABLE, <u>DISABLE</u>
MULTICAST ADDRESS	Set IP address for multicast streaming.	Factory default 239.192.0.20
MULTICAST PORT	Set port number for multicast streaming.	Factory default 37004

3-1-66. LAN PROPERTY

Settings of Wired LAN connection. Available while **MENU > NETWORK > DEVICE SEL** item is set to **"LAN"**.

Menu item		Description	Value
MAC ADDRESS		Display mac address information of a wired LAN adaptor.	----
IPv4 SETTING	DHCP	Set the IP address distribution method using DHCP.	<u>OFF</u> , CLIENT, SERVER
	IP ADDRESS	---	Factory default 192.168.0.1
	SUBNET MASK	---	Factory default 255.255.255.0
	DEFAULT GATEWAY	---	Factory default 192.168.0.254
	PRIMARY DNS	---	Factory default 0.0.0.0
	SECONDARY DNS	---	Factory default 0.0.0.0
IPv6 SETTING	ENABLE/DISABLE	Turn ON/OFF IPv6 connection.	ENABLE, <u>DISABLE</u>
	DHCP	Set the IP address distribution method using DHCP.	<u>OFF</u> , CLIENT
	IP ADDRESS	---	---
	PREFIX LENGTH	Set prefix length of SUBNET.	Factory default 64
	DEFAULT GATEWAY	---	---
	PRIMARY DNS	---	---
	SECONDARY DNS	---	---

[NETWORK] MENU**3-1-67. WLAN PROPERTY**

Settings of Wi-Fi connection. Available while **MENU > NETWORK > DEVICE SEL** item is set to "WLAN".

Menu item		Description	Value (Factory default underlined)
MAC ADDRESS		Display mac address information of a connected Wi-Fi adaptor.	----
TYPE		Set a connection method.	<u>DIRECT</u> Connect to Wi-Fi devices such as a tablet computer without using a wireless access point. INFRA(SELECT) Connect to a wireless access point. Access point can be chosen from an available access point list. INFRA(MANUAL) Connect to a wireless access point. Access point can be searched by entering an SSID manually.
SSID		Display network name of the AG-CX350 unit.	Factory default AG-CX350
BAND		Set connection type. (available when TYPE item is set to "DIRECT")	<u>2.4GHz</u> , 5GHz
CHANNEL(2.4GHz)		Set Wi-Fi channel of 2.4GHz network.	<u>AUTO</u> , CH1, CH6, CH11
CHANNEL(5GHz)		Set Wi-Fi channel of 5GHz network.	<u>AUTO</u> , CH36, CH40, CH44, CH48, CH100, CH104, CH108, CH112, CH116, CH132, CH136, CH140, CH149, CH153, CH157, CH161, CH165
ENCRYPTION		Set signal encryption method for INFRA connection.	WPA-TKIP, WPA-AES, WPA2-TKIP, <u>WPA2-AES</u> , NONE
ENCRYPT KEY		Set connection password.	Factory default password: (01234567890123456789abcdef)
IPv4 SETTING	DHCP	Set the IP address distribution method using DHCP.	<u>OFF</u> , CLIENT, SERVER
	IP ADDRESS		Factory default 192.168.0.1
	SUBNET MASK		Factory default 255.255.255.0
	DEFAULT GATEWAY		Factory default 192.168.0.254
	PRIMARY DNS		Factory default 0.0.0.0
	SECONDARY DNS		Factory default 0.0.0.0

[NETWORK] MENU**3-1-68. INFORMATION**

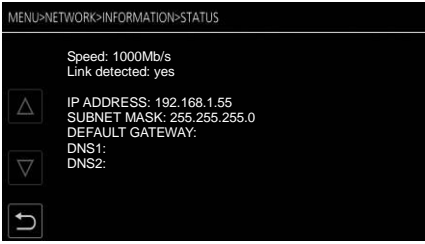
Menu item	Description	Value
STATUS	Display network connection related information.	

3-1-69. UTILITY

Settings of Wired LAN connection. Available while **MENU > NETWORK > DEVICE SEL** item is set to **"LAN"**.

Menu item	Description	Value (Factory default underlined>
NETWORK INITIALIZE	Restore network settings to factory setting.	---
EASY IP SETTING	Set time limit to allow remote control from the EASY IP SETTING software (*1).	<u>DISABLE</u> : Never accept controls 20MIN.: Accept controls for only 20 minutes after power ON. UNLIMITED: Always accept controls.
EASY IP CAMERA TITLE	Set ID name shown on the EASY IP SETTING software (*1).	Factory default <u>AG-CX350</u>

*1 The Easy IP setting software is a free windows application which helps speed up network configurations on Panasonic's professional video products.

Please visit our support website to download at https://panasonic.biz/cns/sav/pass_e.

[SYSTEM] MENU**3-1-70. FREQUENCY**

Menu item	Description	Value (Factory default underlined)
FREQUENCY	Set system frequency. Available TV formats	<u>59.94Hz</u> , 50.00Hz

3-1-71. FILE FORMAT

Menu item	Description	Value
FILE FORMAT	Set record file format.	P2, <u>MOV</u> , AVCHD

3-1-72. REC FORMAT

Menu item	Description	Value
REC FORMAT	Set image quality of video to be recorded. (resolution, frame rate, and bit-rate)	---

3-1-73. ASPECT

Menu item	Description	Value
ASPECT	Set image aspect ratio when REC FORMAT is set to 480i and 576i.	<u>4:3</u> , 16:9

3-1-74. SUPER SLOW

Menu item	Description	Value
SUPER SLOW	Turn ON/OFF super slow record mode. 120fps at 59.94Hz, 100fps at 50.00Hz system frequency.	ON, <u>OFF</u>

SUPER SLOW mode is disabled under the following menu conditions:

MENU > SYSTEM > FILE FORMAT is set to "AVCHD" or "P2"

MENU > SYSTEM > REC FORMAT is set to any format than 1920x1080

MENU > SYSTEM > REC FORMAT is set to **59.94i** or **50.00i**



3-1-75. SHOOTING MODE

Menu item	Description	Value
SHOOTING MODE	Set camera sensitivity mode. HIGH SENS mode is suitable for shooting in dark environments.	<u>NORMAL</u> , HIGH SENS.

[OTHERS] MENU**3-1-76. FILE**

Menu item	Description	Value (Factory default underlined)
SCENE FILE (SD CARD)	Import/store custom scene files from the SD memory card.	LOAD, SAVE, SAVE AS
SETUP FILE (SD CARD)	Import/store custom setup files from/to the SD memory card.	LOAD, SAVE, SAVE AS
SETUP FILE (MEMORY)	Import/store custom setup files from/to the onboard memory device in the unit.	LOAD, SAVE, INITIALIZE
SLOT FOR SAVE/LOAD	Select a card slot to read/load setting files (SCENE, SETUP, STREAMING SETUP).	<u>SLOT1</u> , SLOT2

3-1-77 COLOR BARS

Menu item	Description	Value
COLOR BARS TYPE	Set color bars type.	SMPTE 
		FULL 
TEST TONE	Turn ON/OFF 1KHz tone when color bar pattern is turned ON.	<u>ON</u> , OFF

3-1-78. LED

Menu item	Description	Value
TALLY LED	Set the tally lamp to be used during recording.	FRONT, REAR, <u>BOTH</u> , OFF
ACCESS LED	Set the access lamp to be used when accessing memory card.	<u>ON</u> , OFF

[OTHERS] MENU**3-1-79. CLOCK**

Menu item	Description	Value (Factory default underlined)
CLOCK SETTING	Set the built-in calendar.	---
TIME ZONE	Set time difference to the calendar information.	---
DATE FORMAT	Set date format.	Y-M-D , M-D-Y , D-M-Y

3-1-80. USB DEVICE

Menu item	Description	Value
CARD READER MODE	To be used when operating the unit as a memory card reader with a computer via USB connection.	YES, NO
SERVICE MODE	For service purposes only	YES, NO

3-1-81. INFORMATION

Menu item	Description	Value
VERSION	Show the model number, serial number, network ID (Mac address), the current firmware version.	---
OPERATION TIME	Show the following operation hours and times (cumulative)	---
UPDATE	Executes firmware update.	---

The latest firmware is available on the support website at https://panasonic.biz/cns/sav/pass_e .

3-1-82. LANGUAGE

Menu item	Description	Value
LANGUAGE	Set the menu language	---

3-1-83. MENU INITIALIZE

Menu item	Description	Value
MENU INITIALIZE	Restore the product to factory settings.	YES, NO

[OPTION] MENU

Keep pressing EXIT button and press MENU to open.



3-1-84. AREA SETTINGS

Menu item	Description	Value (Factory default underlined)
AREA SETTINGS	Change certain menu items such as DATE FORMAT, HEADROOM by area setting. See the table below for the details.	<u>AREA1: Japan</u> AREA2: Taiwan, South Korea AREA3: United States, Canada, Central and south America AREA4: Asia, Oceania, India, and other region.



AREA SETTINGS changes following menu items

Menu item	AREA1	AREA2	AREA3	AREA4
FREQUENCY	59.94Hz	59.94Hz	59.94Hz	50.00Hz
REC FORMAT	1080-59.94i/422 ALL-I 100M	1080-59.94i/422 ALL-I 100M	1080-59.94i/422 ALL-I 100M	1080-50.00i/422 ALL-I 100M
DATE FORMAT	Y-M-D	Y-M-D	M-D-Y	D-M-Y
HEAD ROOM	20dB	20dB	20dB	18dB
LANGUAGE	日本語, English	Fix to English, and no Language option is displayed	English, Español, Français	English, Español, Français

4. Understanding advanced features



4-1. Understanding live streaming feature via YouTube, Facebook

The AG-CX350 features HD live streaming function (supports RTSP, RTMP, and RTMPs protocols) via live streaming services (*1) such as YouTube and Facebook. (Please prepare accounts on the YouTube and Facebook in advance.)

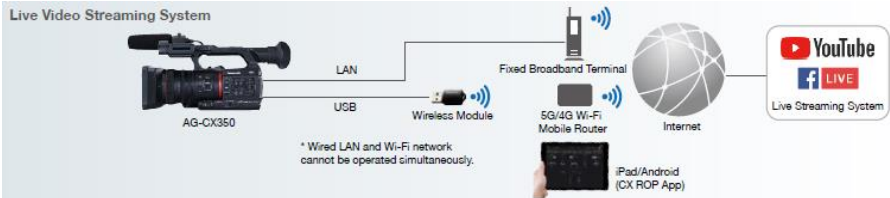

*1 Tested live streaming service information

https://pro-av.panasonic.net/en/service_support/live_video/index.html

Necessary equipment

No	Equipment	Description
1	AG-CX350 unit	Connected to network (*2)
2	P2 Network Setting Software for Windows. (P2netGen.exe)	For creating a connection profile. Available from the following support website for free. https://eww.pass.panasonic.co.jp/pro-av/support/content/download/EN/ep2main/nw_setting_e.htm
3	SD memory card	For importing a connection profile to a camera.

*2 Factory tested Wi-Fi module information

https://pro-av.panasonic.net/en/sales_o/p2/server/wireless_module.html

Preparation (setting example on YouTube)

1. Log-in to a YouTube account and move to live video transmission (Go live) page.

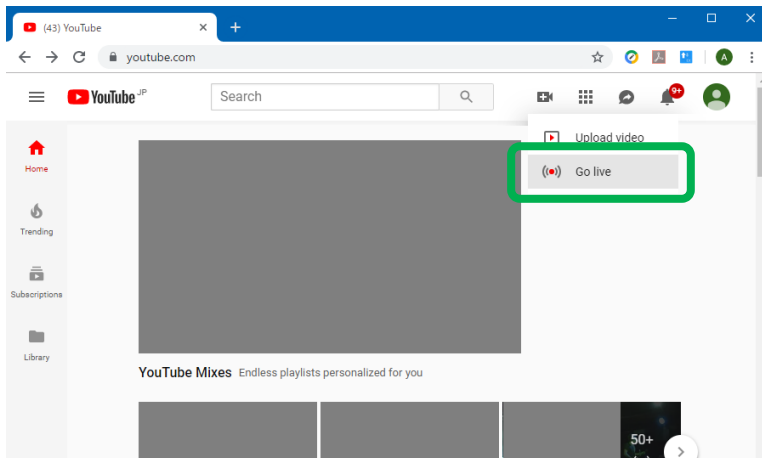

- At the ENCODER SETUP screen, show the server URL, and your stream name/key (ID and passcode to log-in to the server).

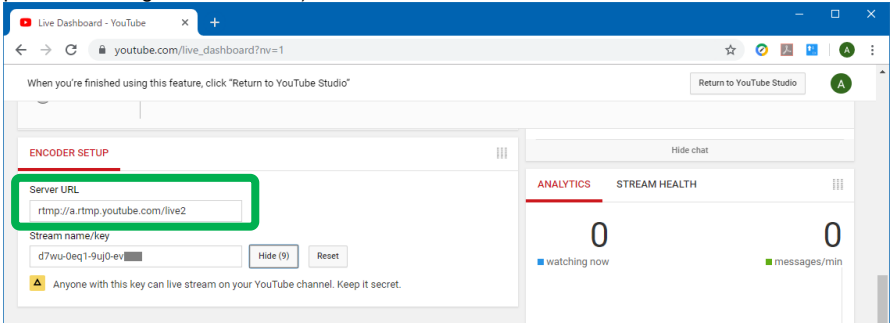

Example of Live streaming setting screen on YouTube

Import connection profile to the AG-CX350 unit with following procedure.

- Download the P2 Network setting software (P2netGen.exe) from following website and execute.
https://eww.pass.panasonic.co.jp/pro-av/support/content/download/EN/ep2main/nw_setting_e.htm
- Mount an SD memory card to the PC.
- Select “Streaming” > “RTMP” tab, and then enter the “Server URL” and “Stream name/key” in the STREAM DESTINATION URL field, separated with a “/” (slash symbol).

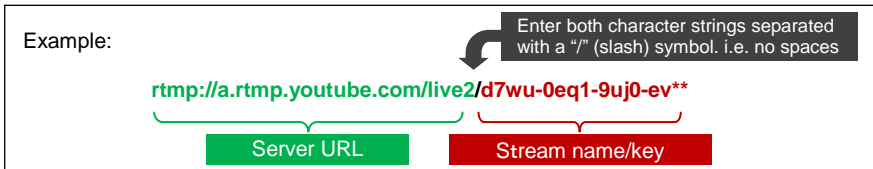

- Click “Export” button to export a connection profile to the SD memory card.

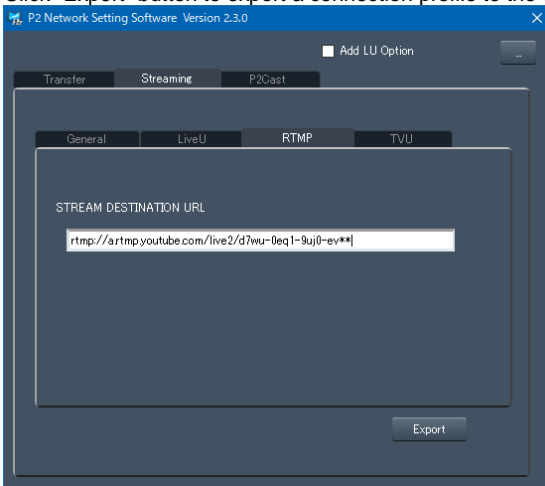

Configuring network settings on the AG-CX350

FOR WI-FI CONNECTION

Menu item	Value
MENU > NETWORK >	
DEVICE SEL	WLAN
MENU > NETWORK > WLAN PROPERTY	
TYPE	DIRECT
SSID	Enter any word (Default: AG-CX350)
BAND	Choose "2.4GHz" or "5GHz" depends on Wi-Fi adaptor type.
CHANNEL(2.4GHz)	AUTO
CHANNEL(5GHz)	AUTO
ENCRYPT KEY	Enter connection password used to connect to the AG-CX350. (Default: 01234567890123456789abcdef)
MENU > NETWORK > WLAN PROPERTY > IPv4 SETTING	
DHCP	Choose "SERVER" or "OFF" depends on network environment.)
IP ADDRESS	Default: 192.168.0.1
SUBNET MASK	Default: 255.255.255.0
DEFAULT GATEWAY	Default: 192.168.0.254

FOR WIRED LAN CONNECTION

Menu item	Value
MENU > NETWORK >	
DEVICE SEL	LAN
MENU > NETWORK > LAN PROPERTY > IPv4 SETTING	
DHCP	Choose "SERVER" or "OFF" depends on network environment.)
IP ADDRESS	Default: 192.168.0.1
SUBNET MASK	Default: 255.255.255.0
DEFAULT GATEWAY	Default: 192.168.0.254

7. Set following menu items to start streaming

Menu item	Value
MENU > NETWORK >	
NETWORK FUNC	STREAMING
MENU > NETWORK > STREAMING	
STREAMING FORMAT	Choose TV image signal format. Available formats will vary depending on current system format. See 6-5. Streaming format (Protocol RTMP) (P.84) for details.
CONNECTION INFO.	SD CARD
START TRIGGER	CAMERA

8. Mount the SD memory card with stored connection profile to Slot1 on the AG-CX350.
 9. Load the profile from the card to the AG-CX350.



MENU > NETWORK > STREAMING > LOAD (SD CARD)

10. Connect the AG-CX350 to network via Wi-Fi or LAN.

11. Set MENU > NETWORK > STREAMING > START item to "ON" to start streaming form the AG-CX350. The "START" function can also be assigned to one of user buttons (P.17).

See next page for troubleshooting of live streaming

Troubleshoot

Symptom	Major cause and measure
<p>Streaming stops (“START” item reverts to “OFF” right after starting)</p>	<p>Camera cannot reach the server</p> <ul style="list-style-type: none"> - Is the camera connected to network? - Is the connection info (Server URL, and Stream name/key) correctly registered with P2NetGen software? - Is the port No. TCP 1935 correctly opened (i.e. not blocked)? <p>Streaming status can be confirmed with the icon displayed in upper left corner of viewfinder. Example icons below.</p> <div style="display: flex; align-items: center; margin-bottom: 10px;">  <div style="margin-left: 10px;">Connected to the streaming service and transmitting audio and video.</div> </div> <div style="display: flex; align-items: center; margin-bottom: 10px;">  <div style="margin-left: 10px;">Streaming is ready, audio and video transmission is idle.</div> </div> <div style="display: flex; align-items: center;">  <div style="margin-left: 10px;">Streaming is not functioning due to some trouble.</div> </div>
<p>MENU > NETWORK > NETWORK FUNC item does not work (grayed out).</p>	<p>Streaming function is not currently available due to other feature settings. It will not function under following conditions.</p> <ul style="list-style-type: none"> - MENU > SYSTEM > REC FORMAT item is set to 2160p formats. Streaming function is available in HD modes only. - MENU > RECORDING > 2 SLOT FUNC. > BACKGR REC - MENU > SYSTEM > FILE FORMAT > AVCHD. - MENU > SYSTEM > SUPER SLOW > ON

4-2. Video/audio output

The AG-CX350 is equipped with HDMI and SDI (3G-SDI) terminals. Both terminals can be used simultaneously.



HDMI OUT
(Support up to
UHD 2160/59.94p)

SDI OUT
(Supports 1080/59.94p)

Settings of SDI OUT

1. MENU > SYSTEM > FREQUENCY
2. MENU > SYSTEM > REC FORMAT
3. MENU > VIDEO OUT/LCD/VF > SDI OUT > OUT FORMAT

Available video format varies and depends on above settings.
See 6-3. Output signals (SDI) (P.82) for details.

Settings of HDMI OUT

1. MENU > SYSTEM > FREQUENCY
2. MENU > SYSTEM > REC FORMAT
3. MENU > VIDEO OUT/LCD/VF > HDMI OUT > OUT FORMAT

Available video format varies and depends on above settings.
See 6-4. Output signals (HDMI) (P.83) for details.

4-3. Understanding focus assist features

The AG-CX350 series is equipped with following two focus assist features to make focusing easier when recording in 4K/UHD higher resolution formats. Two different assist modes (EXPAND and PEAKING) can be individually recalled with USER assignable buttons.

EXPAND



Part of image can be magnified up to 4 times (x2, x3, x4). Its magnification period can be set 3 different ways (see EXPAND MODE below).

HOW TO USE

1. Assign "EXPAND" to one of the USER buttons in MENU > CAMERA > USER SW.
2. Set the power in MENU > VIDEO OUT/LCD/VF > FOCUS ASSIST > FOCUS ASSIST SW > EXPAND VALUE > [x2] [x3] [x4]
3. Set magnification period in MENU > VIDEO OUT/LCD/VF > FOCUS ASSIST > FOCUS ASSIST SW > EXPAND MODE.
[10SEC] Magnify for 10 seconds, and return to x1 after that.
[HOLD] Keeps magnification until function is released when USER button is pressed again.
[UNTIL REC] Keeps magnification until recording starts.
4. Press "USER" button assigned with "EXPAND" function or press FOCUS ASSIST button.

PEAKING



Adds colored highlights to in-focus edges. Highlight levels can be adjusted, and its color can also be selected from four different colors.

It can also be used in combination with "EXPAND" focus assist mode.

HOW TO USE

1. Assign "PEAKING" to one of the USER buttons in MENU > CAMERA > USER SW.
2. Adjust the highlight level.
MENU > VIDEO OUT/LCD/VF > FOCUS ASSIST > PEAKING LEVEL
3. Select its highlighting color
MENU > VIDEO OUT/LCD/VF > FOCUS ASSIST > PEAKING COLOR > RED, GREEN, WHITE
4. Press "USER" button assigned with "PEAKING" function or press FOCUS ASSIST button.

4-4. Understanding Dual memory card slots

Various recording modes are available with dual memory card slots.

SIMUL REC

Record the same content onto two cards simultaneously. Even if recording stops on one card, recording on the other card continues.

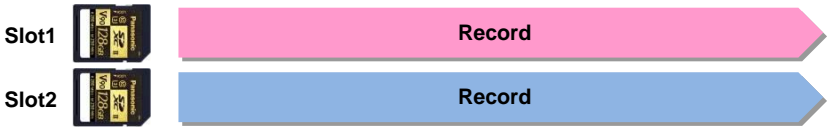

Note:

- Recording on both cards stops when one of the cards is exhausted.
- Panasonic recommends using the same type (capacity and speed) cards for stable operation.

RELAY REC

Recording slot changes without interruption from one card to another. Suitable for long duration recordings. Cards not currently in record mode can be replaced with another while recording continues in the other slot.

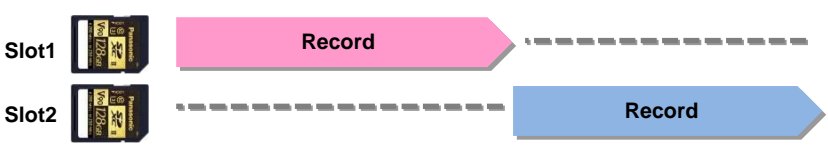

Note: The maximum continuous record time is up to 10 hours, recording stops when 10 hours has been reached. Recording will automatically recommence after a few seconds.

BACKGR REC

Perform continuous recording to one SD card, even though the other SD card can start and stop recording as required.

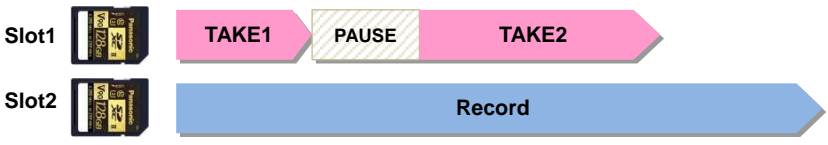

Note: To stop recording on slot2, keep pressing the USER button which has "BACKGR PAUSE" assigned to it or "EXIT" button for 5 seconds.

Using the 2 slot features

MENU > RECORDING > 2 SLOT FUNC. > SIMUL REC, RELAY REC, BACKGR REC

4-5. Synchronizing timecode for multi-cam operation

The AG-CX350 is equipped with a timecode IN/OUT terminal (common use for IN and OUT). The following describes workflow know-how when using time code synchronization feature with two AG-CX350 units.

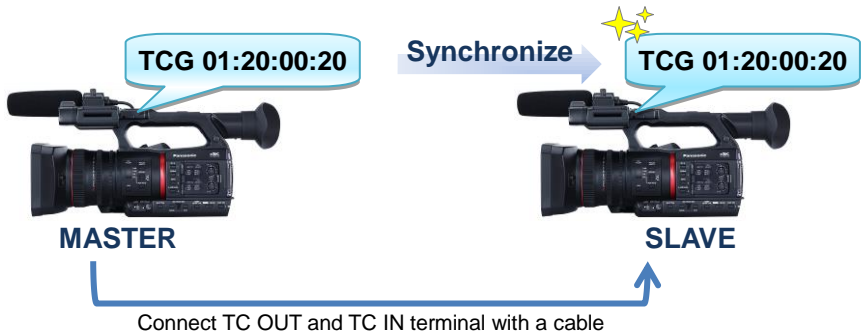

Preparation

1. Connect TC PRESET IN/OUT terminals on both master and slave units with a BNC cable.
2. Make sure that the settings of following menu items are the same for both units.

↑

MENU > SYSTEM > FREQUENCY
MENU > SYSTEM > REC FORMAT

Setting for master unit

1. Set MENU > RECORDING > TC/UB > TC IN/OUT SEL item to "TC OUT".
2. Set MENU > RECORDING > TC/UB > DF/NDF item to "NDF".
 The DF/NDF item is fixed to "NDF" when FREQUENCY setting is 23.98p, 24.00p, 25.00p, 50.00p, or 50.00i.

Setting for slave unit

1. MENU > RECORDING > TC/UB > FREE/REC RUN item to "FREE RUN".
2. MENU > RECORDING > TC/UB > TC IN/OUT SEL item to "TC IN".



TC IN/OUT

NOTE:

The timecode synchronization may differ by 1 frame between the units because the AG-CX350 has no genlock function.

While the slave unit is recording, synchronization will not be performed. The internal timecode generator will continue to run and count up until recording has stopped.

When switching power source from battery pack to AC adaptor, Do NOT remove the battery pack until the power source indicator changes to , otherwise the continuity of the timecode count will not be maintained.

4-6. Understanding Remote operation via CX ROP iPad app

Remote control via Wi-Fi network is available by using an application for iPad, iPhone and Android devices.

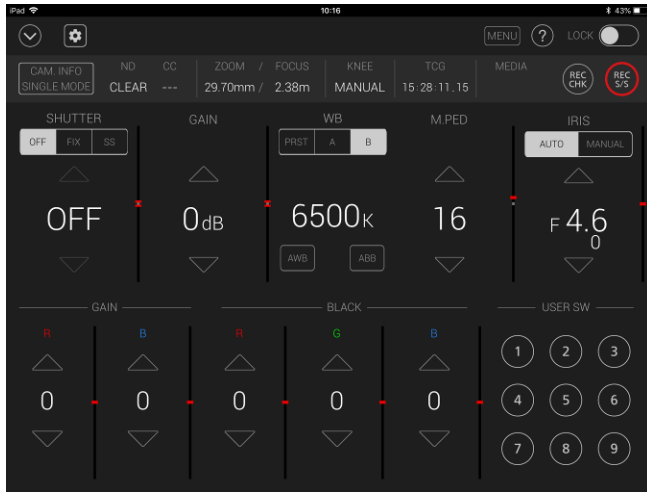

Necessary equipment

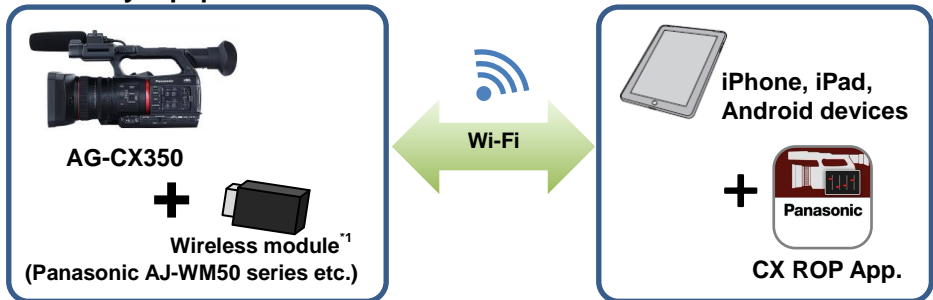

*1 For factory tested wireless modules, please visit at https://pro-av.panasonic.net/en/sales_o/p2/server/wireless_module.html

Setting up equipment (overview)

1. Download the CX ROP app from Apple App Store or Google Play, and then install to a mobile device.
2. Connect a wireless module (optional) to the USB 2.0 HOST terminal on the AG-CX350.
3. Configure Wi-Fi related settings on the AG-CX350.
4. Configure Wi-Fi related settings on the mobile device, and then connect to the AG-CX350.
5. Start Panasonic CX ROP app.

Set up example

Setting on AG-CX350

1. Connect a wireless module (optional) to the USB2.0 HOST terminal.
2. Set following USB related menu items to enable the USB port for EVA ROP connection.
MENU > NETWORK > DEVICE SEL > WLAN



3. Set network related menu items

Menu item	Value
MENU > NETWORK > WLAN PROPERTY	
TYPE	DIRECT
SSID	Set your preferred name (factory default: AG-CX350)
BAND	Choose "2.4GHz" or "5GHz" depends on Wi-Fi adaptor type.
CHANNEL (2.4GHz)	AUTO
CHANNEL (5GHz)	AUTO
ENCRYPT KEY	Enter connection password used to connect to the AG-CX350 from the mobile tablet device. (Default: 01234567890123456789abcdef)
MENU > NETWORK > WLAN PROPERTY > IPv4 SETTING	
DHCP	SERVER
IP ADDRESS	Default: 192.168.0.1
SUBNET MASK	Default: 255.255.255.0
DEFAULT GATEWAY	Default: 192.168.0.254

4. Set an account in MENU > NETWORK > NETWORK FUNC

Menu item	Value
MENU > NETWORK > IP REMOTE	
ENABLE/DISABLE	ENABLE
USER ACCOUNT	<p>Set an account (ID name and its password) used for authentication from the CX ROP</p> <p>Account name: within 31 characters Password: Minimum 8 characters, up to 15 characters.</p> <p>* There is no preset account, please create an account,</p>

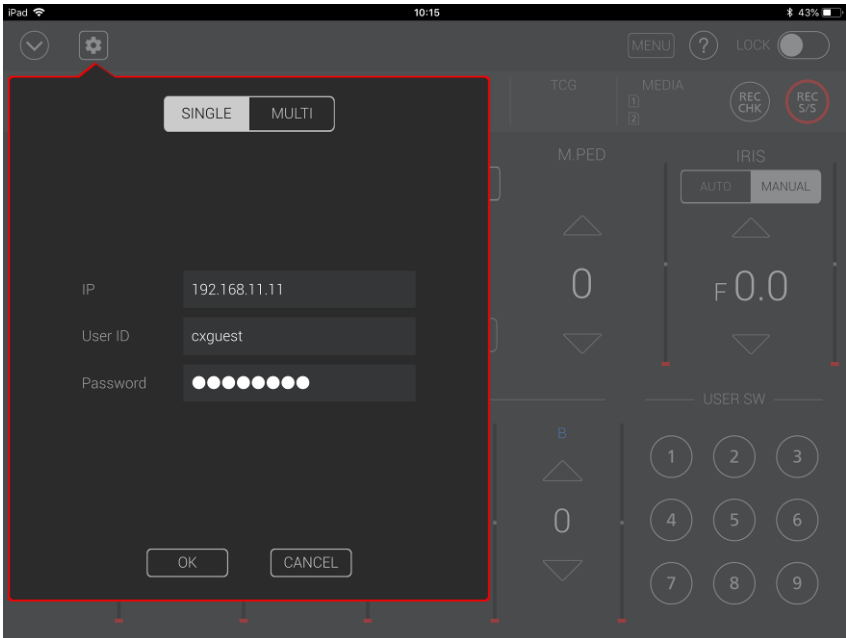

Setting on tablet device (on Apple iPad for example)

1. Install the Panasonic CX ROP app from App Store.
2. Open "Setting"  > Wi-Fi > ", and choose the SSID of the camera (example AG-CX350).
3. Enter connection password (factory default: 01234567890123456789abcdef) to connect the AG-CX350 via Wi-Fi network.
4. Open the Panasonic CX ROP app on the iPad. Tap  symbol and complete authentication settings by entering "IP address, user ID (factory setting: guest), and password (factory setting: cxgust) of the AG-CX350.
5. Confirm that the connection status of the AG-CX350 is shown as  (ready to be controlled from the app.).
6. Start operation from the app.



Setting example on the Panasonic CX ROP application for iPad

Connection status on the AG-CX350

	No connection to the network.
	Connected to the network but not connected to the CX ROP.
	Connected to the CX ROP.

4-7. Updating firmware

1. Download firmware package from the support website at https://panasonic.biz/cns/sav/pass_e
2. Unzip the package and copy "UPDATE.HDC" file to the **ROOT (the top-most) directory** in the SD memory card.

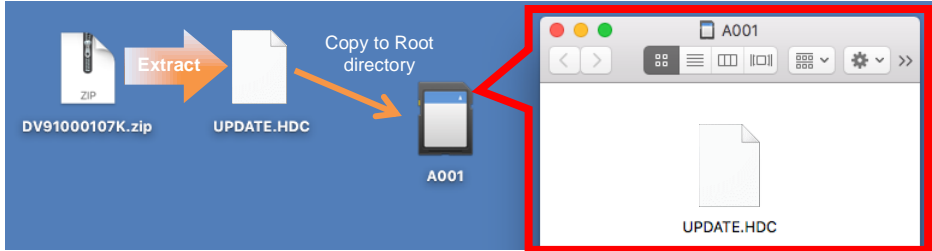

3. Mount the SD memory card to the **SLOT1 (Not SLOT2)** in the AG-CX350.
4. Execute update (**MENU > OTHERS > INFORMATION > UPDATE**)



5. Finally confirm the version (**MENU > OTHERS > INFORMATION > VERSION**)

Troubleshoot

Error message on AG-CX350	Check points
	<ul style="list-style-type: none"> • Is the file name of the firmware on the SD card "UPDATE.HDC"? • Renamed files (e.g.: UPDATE.HDC2, UPDATE.HDC-1, etc.) are not accepted. • Is the SD card inserted in Slot1? Update cannot be performed in Slot2! • Is the UPDATE.HDC file correctly copied to the root directory of the SD card?

5. Understanding scene file operations

AG-CX350

The following six different scene presets come standard with the camera, and can be user customized if required.

5-1. Scene file presets

F1:	Basic setting
F2: FLUO	Suitable for recording where the characteristics of fluorescent lamps are taken into consideration (example: shooting indoors). Most of the parameters are equal to “F1:” but the MATRIX is adjusted for fluorescent lighting. This is not particularly necessary under fluorescent lighting that closely matches natural light color temperature. But it is suitable for recording conditions where the color reproduction is poor due to blue-intense fluorescent lamps.
F3: SPARK	Suitable for recording with richer color level and sharper contrast. The picture will be dramatic with vivid colors and a bright impression.
F4: B.STR	Suitable for recording where the gradation is expanded in dark areas of the image (e.g. shooting a sunset scene). This is effective if being used when dark image areas are difficult to see or both bright and dark scenes need to be seen in detail for example while shooting at sunset, in a theater or at a wedding.
F5: CINE	Suitable for movie-like recording.
F6: HLG	Record mode in HDR (High Dynamic Range). It allows recording naturally high contrast images.

See 6-2. Scene file preset (P.80) for detailed menu settings of each preset.

5-2. Expressing the texture of objects (detail enhancement)

When expressing the outline or surface texture of an object, faint reflection of light may be intensified or, to the contrary, the picture may look blurred. This is a phenomenon caused by the strength / weakness of Detail signal to intensify the video signal for the object's outline. Adjustment of Detail signal can make the object's luster or texture look more natural.

MASTER DETAIL: +31



MASTER DETAIL: -31



5-3. Basic settings for Details

MENU > SCENE FILE (Factory settings underlined)

[MASTER DETAIL] -31 --- 0 --- 31

Adjusts the level of overall Detail effect.

[DETAIL CORING] 0 --- 1 --- 60

Sets the level of signal (including noise) that suppresses the Detail effect.

More precise settings MENU > SCENE FILE > DETAIL SETTINGS (Factory settings underlined)

[DETAIL] ON, OFF

Turn ON/OFF detail enhancer.

[V DETAIL LEVEL] -7 --- 0 --- 7

Sets the intensity of Detail level in the vertical direction.

[H.DTL FREQ.] -7 --- 0 --- 7

Sets the thickness of Detail signal.

[LEVEL DEPEND.] -7 --- 0 --- 7

When the Detail of luminance signal is intensified, the Detail of darker areas are compressed. If this setting value is larger, the Detail of brighter areas will be compressed.

[KNEE APE LVL] 0 --- 2 --- 5

Sets the Detail level of high-luminance areas (very bright areas).

[DTL GAIN (+)] -31 --- 0 --- 31

Sets the Detail level in the positive (brightening) direction separately.

[DTL GAIN (-)] -31 --- 0 --- 31

Sets the Detail level in the negative (darkening) direction separately.

5-3-1. Detail control

This is an outline signal which is added to the video signal.

If the Detail level is increased, the edges of video signal will be intensified and outlines in the picture will look sharper. If the Detail level is decreased, the edges of video signal will be weakened and the picture will look softer with its outline enhancement suppressed.

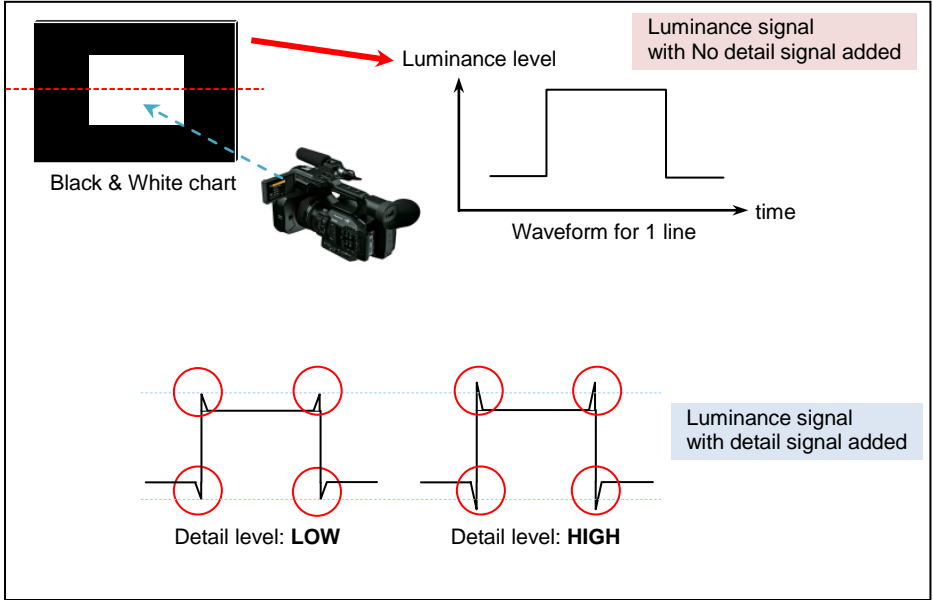

5-3-2. DETAIL GAIN(+) (-) control

The AG-CX350 has individual gain control of detail signal for both positive (signal level is higher) and negative (signal level is lower) direction.

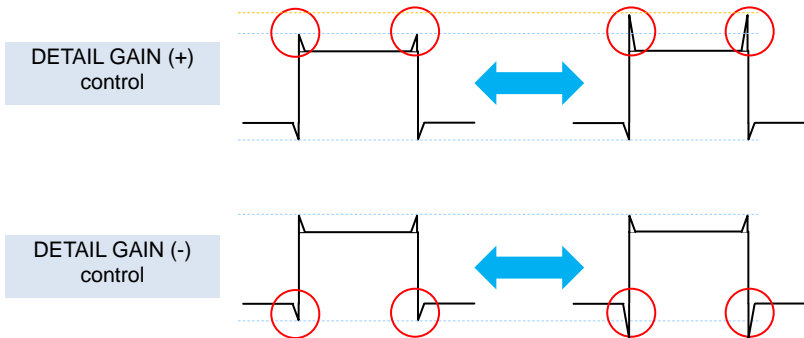

5-3-3. MASTER DETAIL control

Effect comparison of detail control by changing MASTER DETAIL. See below for the concept.

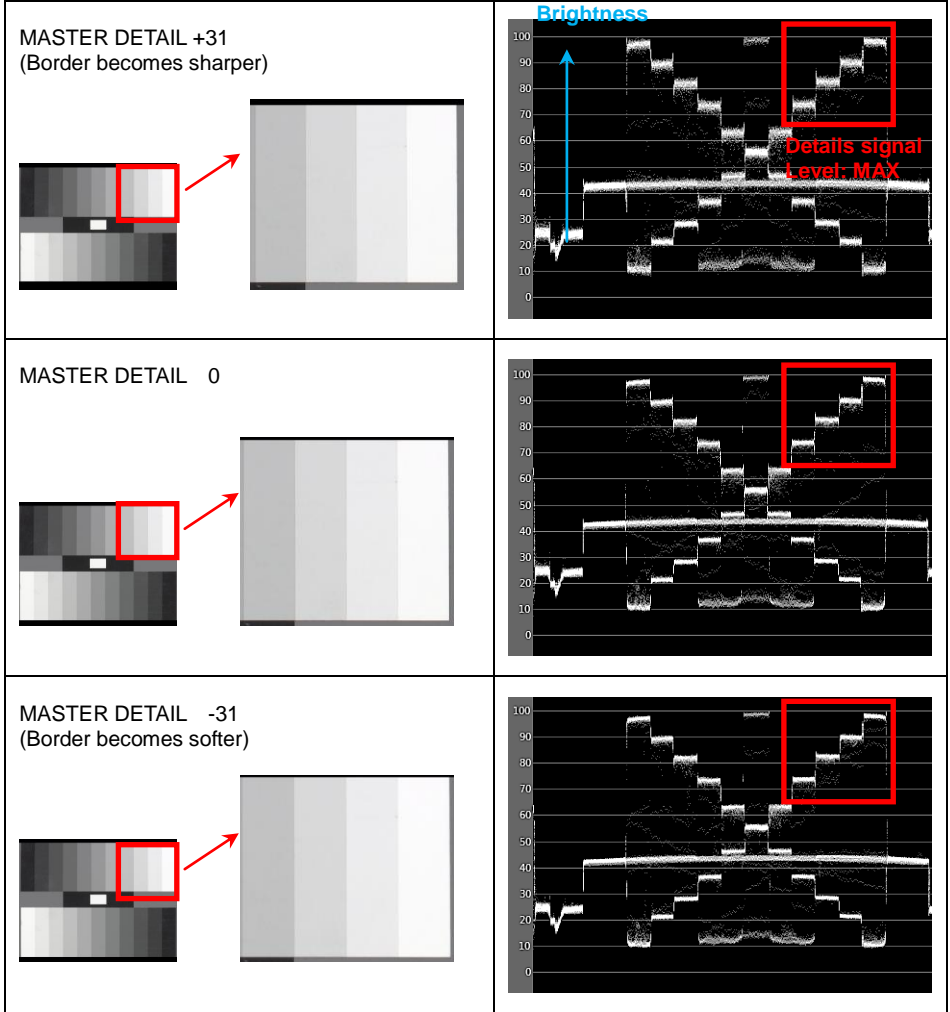

5-3-4. DETAIL CORING control

Outline compensation can be performed by adjusting the Detail which enhances outlines and helps create clear representation of images. But at the same time it may make the picture look coarse and grainy. This occurs because added Detail will also work on low-level signals which includes noise.

Detail coring function can adjust the range of added Detail signal but also helps to reduce the noise introduced by the Detail circuits.

Noise is a low-level signal. So, when Detail coring is set to a higher level than noise signals, the Detail signal will work only on higher-brightness signals, and not on the noise.

By using this control, the outline of an object can be enhanced and its texture will look the same while the effects of increased image coarseness are suppressed.

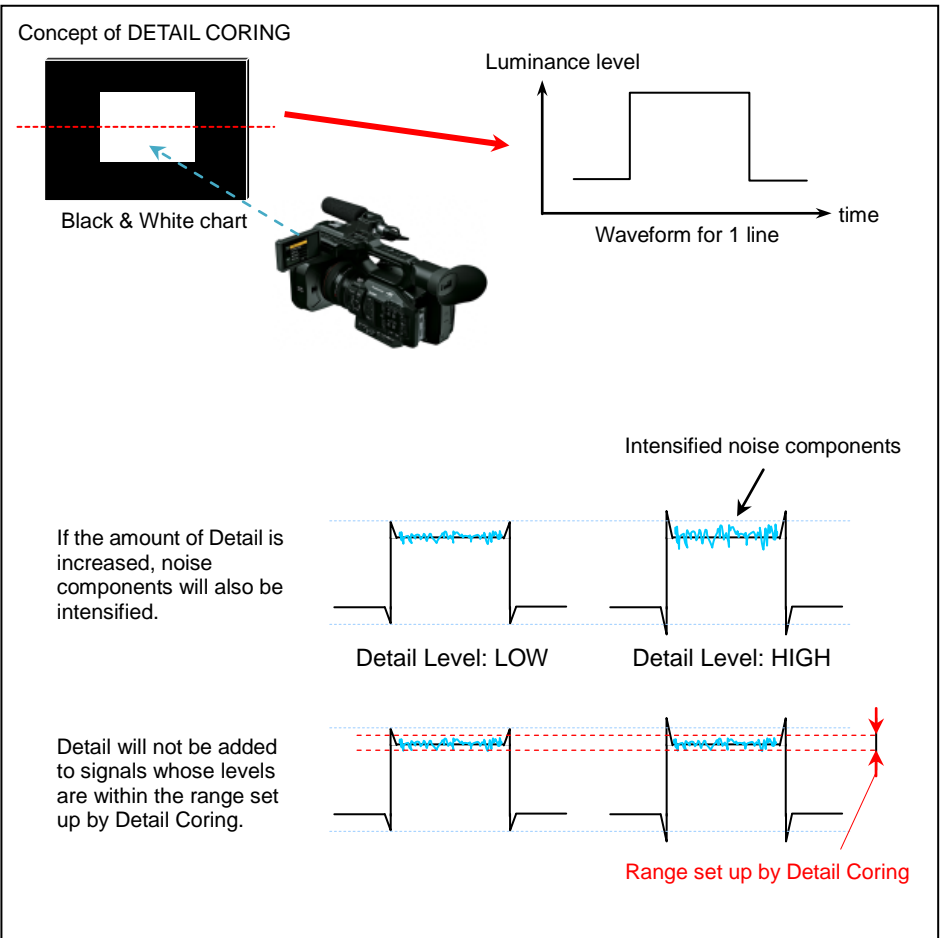

5-3-5. LEVEL DEPENDENT control

To avoid appearance of noise component in dark areas, detail signal at these levels are suppressed. This control adjusts detail signal level in the area.

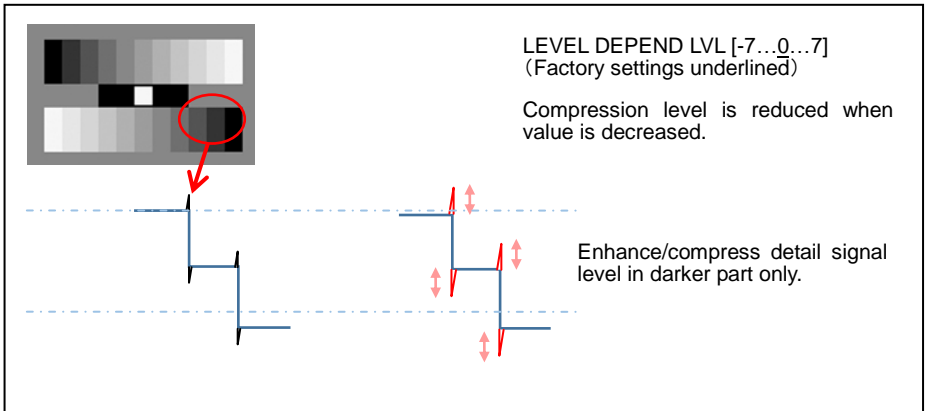

5-3-6. KNEE APE control

When compressing highlight portions with KNEE control due to overexposed image (blown-out highlights), detail signals will also be compressed and may cause softening in highlight areas. This can be compensated by using KNEE APE LEVEL control.

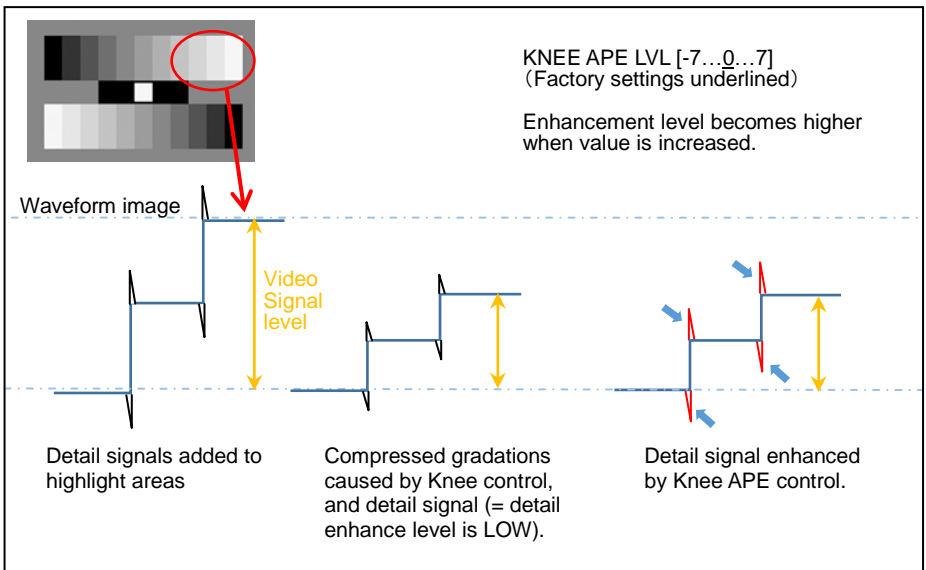

5-4. Expressing the gradation of an image (Knee, Gamma)

5-4-1. KNEE control

Due to bright sunny weather or lighting, “blown-out highlights” can sometimes occur, where bright areas look completely white with little to no detail visible. This is a phenomenon caused by the luminance signals that are out of the camera’s Dynamic Range (processing range). In order to put such high-brightness input signals within the camera’s Dynamic Range, Knee function can be used to compress the gradations.

MENU > SCENE FILE > (Factory default settings underlined)

[KNEE MODE] AUTO / MANUAL / OFF

AUTO: Adjusts master point and slope automatically.

MANUAL: Knee master point and slope can be adjusted manually.

OFF: Knee mode not used.

[KNEE MASTER POINT] 80.0 --- 93.0 --- 107.0

Sets the position of Knee Point. (* Enabled when KNEE MODE is MANUAL)

[KNEE MASTER SLOPE] 0 --- 85 --- 99

Sets the slope of Knee. (* Enabled when KNEE MODE is MANUAL)

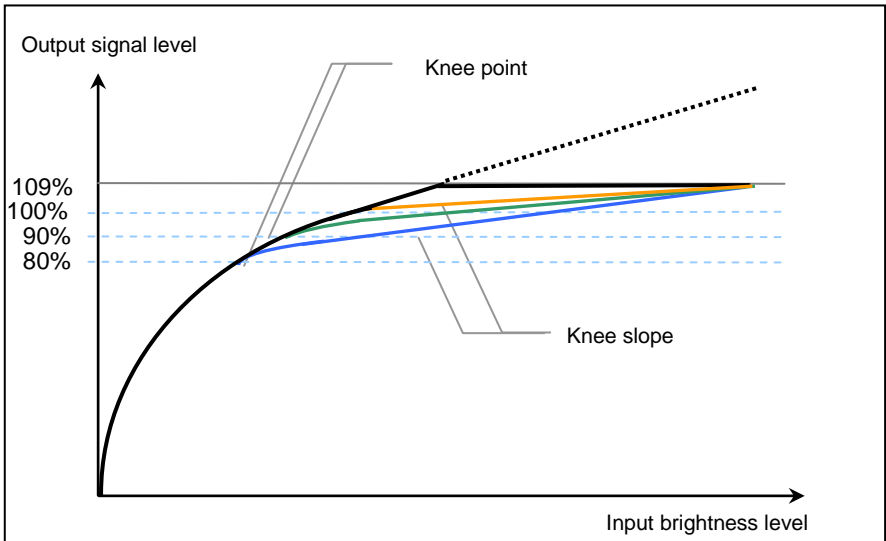

The above graph is for explanation purposes only and may be different from actual measurements.

KNEE MASTER POINT: 107%

Highlight areas tend to be overexposed (no gradations visible) when value is increased.



KNEE MASTER POINT: 93.0%



KNEE MASTER POINT: 80.0%

Gradations in the highlight areas become visible when value is decreased.



5-4-2. GAMMA settings

There are cases where the color and contrast, which look natural to the eye, are not fully reproduced in the captured image. An effective way to improve the gradation of the output signal is to select a suitable Gamma curve according to the scene conditions. The AG-CX350 series offers eight types of different Gamma curves.

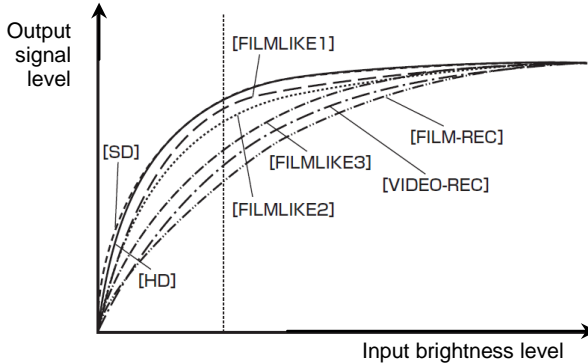

<p>HD: This is a video Gamma characteristic for HD (High Definition). This Gamma complies with the standards defined by ARIB, EBU, SMPTE, etc. Use this for the purpose of normal HD shooting.</p>
<p>SD: Gain is increased for dark areas more so than HD Gamma. This Gamma curve can be used for shooting in SD mode, or for HD shooting that needs the same Gamma as used in SD shooting.</p>
<p>FILMLIKE 1: Compared with HD Gamma, this has the characteristics by which the gradation of the highlights can be reproduced better. Using this Gamma curve which gently slopes for the low-brightness area, makes the picture look calm. Contrast becomes sharper and the gradation expression of the middle- and high-brightness areas (face, etc.) is extended.</p>
<p>FILMLIKE 2: Compared with FILM LIKE 1, this has the characteristics by which the gradation of the highlights can be reproduced better.</p>
<p>FILMLIKE 3: Compared with FILM LIKE 2, this has the characteristics by which the gradation of the highlights can be reproduced better.</p>
<p>FILM REC This Gamma gives priority to the Dynamic Range and maintains the gradation that ranges evenly from low to high level. Black stretch level (level control for dark areas) can be adjusted with "F REC BLACK STRETCH" menu item.</p>
<p>VIDEO REC This is a cinema like gamma characteristic. Knee point can be adjusted with "V-REC KNEE POINT" menu item.</p>
<p>HLG This is a Hybrid Log Gamma characteristics for wider dynamic range filming..</p>

5-4-3. BLACK GAMMA control

Dark parts of the image can be lifted or suppressed with this control. See below for the concept.

MENU > SCENE FILE > (Factory default settings underlined)

[BLACK GAMMA] -8 --- 0 --- 8

Sets gamma characteristic for dark part of the image.

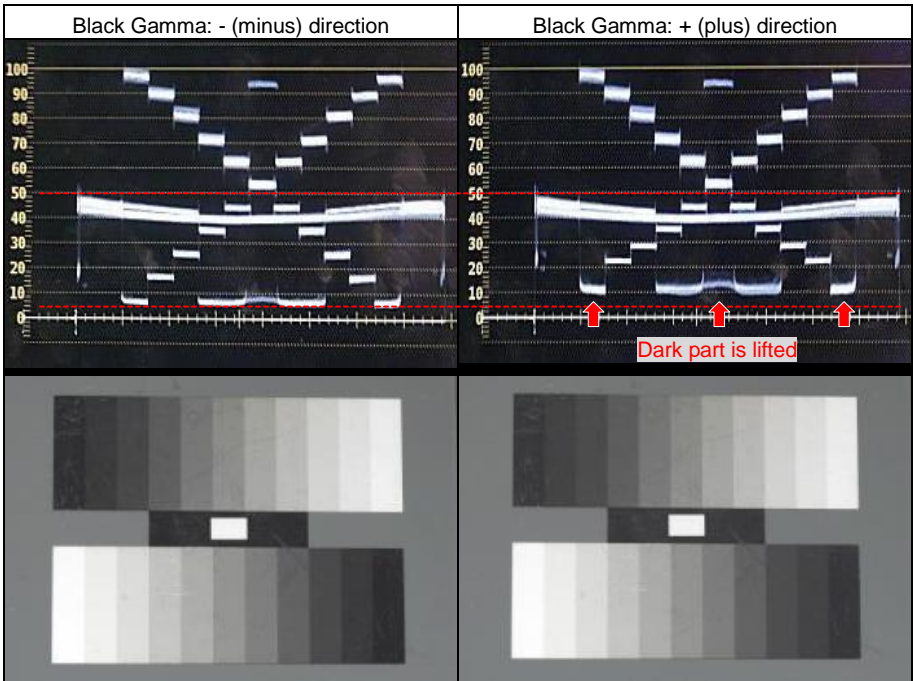





By utilizing Black gamma control, dark parts of the image such as hair lines, casted shadows etc. can be expressed without changing brightness of entire image.

6. Appendix

AG-CX350

6-1. Battery runtime

Part number	Voltage & capacity (Minimum)	Hours to charge ^{*1}	Operation time ^{*2}
 VW-VBR59 (comes standard/optional)	7.28V 5900mAh, 43Wh	3h20min	3h20min
 VW-VBR89G (Optional)	7.28V 8850mAh, 64Wh	4h00min	5h00min
 VW-VBR118G (Optional)	7.28V 11800mAh, 86Wh	4h40min	6h40min
 VW-VBD58 (Optional)	7.2V 5800mAh, 42Wh	5h20min	3h10min

*1 Charging times are measured at an ambient temperature of 25°C / 77.0°F, and relative humidity at 60%, using the battery charger that comes standard with product. N.B. it may vary under different conditions.

*2 Operation times are measured under following conditions, Times may vary under different conditions.

- Menu settings, factory default.
- Opening built-in LCD panel, no any other cables are connected to any IN/OUT terminals.

6-2. Scene file preset

Menu item		Presets					
		F1:	F2: FLUO	F3: SPARK	F4: B.STR	F5: CINE	F6: HLG
VFR		OFF	OFF	OFF	OFF	OFF	OFF
FRAME RATE		24fps *1 , 25fps *2					
SYNC SCAN TYPE		sec	sec	sec	sec	sec	sec
SYNC SCAN		1/60.0 *1 , 1/50.0 *2					
MASTER DTL		0	0	8	0	0	0
DTL CORING		15	15	25	15	15	15
DETAIL SETTING	DETAIL	ON	ON	ON	ON	ON	ON
	V DTL LVL	0	0	0	0	0	0
	DTL FREQ.	0	0	0	0	0	0
	LEVEL DEPEND.	0	0	0	0	0	0
	KNEE APE LVL	2	2	2	2	2	2
	DTL GAIN (+)	0	0	0	0	0	0
	DTL GAIN (-)	0	0	0	0	0	0
SKIN TONE DTL A,B,C		OFF	OFF	OFF	OFF	OFF	OFF
SKIN TONE ZEBRA		ON	ON	ON	ON	ON	ON
SKIN TONE DTL SETTING	DETECT TABLE	A	A	A	A	A	A
	SKIN DTL EFFECT	16	16	16	16	16	16
	I CENTER	35	35	35	35	35	35
	I WIDTH	2	2	2	2	2	2
	Q WIDTH	2	2	2	2	2	2
	Q PHASE	0	0	0	0	0	0
RB GAIN CONTROL SETTING	R,B GAIN AWB PRE	0	0	0	0	0	0
	R,B GAIN AWB A	0	0	0	0	0	0
	R,B GAIN AWB B	0	0	0	0	0	0
	AWB A GAIN OFFSET	OFF	OFF	OFF	OFF	OFF	OFF
	AWB B GAIN OFFSET	OFF	OFF	OFF	OFF	OFF	OFF
COLOR TEMP A/B ch SETTING	COLOR TEMP	3200K	3200K	3200K	3200K	3200K	3200K
	R GAIN	0	0	0	0	0	0
	B GAIN	0	0	0	0	0	0
	G AXIS	0	0	0	0	0	0

*1 When MENU > SYSTEM > FREQUENCY item is set to 59.94Hz

*2 When MENU > SYSTEM > FREQUENCY item is set to 50.00Hz

6-2. Scene file preset (continued)

Menu item		Presets					
		F1:	F2: FLUO	F3: SPARK	F4: B.STR	F5: CINE	F6: HLG
CHROMA LEVEL		0%	0%	0%	0%	0%	0%
CHROMA PHASE		0	0	0	0	0	0
MATRIX		NORMAL 1	FLUO.	NORMAL 2	NORMAL 1	CINE LIKE	NORMAL 1
ADAPTIVE MATRIX		OFF	OFF	OFF	OFF	OFF	OFF
MATRIX SETTING	R-G	0	0	0	0	0	0
	R-B	0	0	0	0	0	0
	G-R	0	0	0	0	0	0
	G-B	0	0	0	0	0	0
	B-R	0	0	0	0	0	0
	B-G	0	0	0	0	0	0
RGB BLACK CONTROL SETTING	MASTER PEDESTAL	16	16	16	16	16	16
	R PED	0	0	0	0	0	0
	G PED	0	0	0	0	0	0
	B PED	0	0	0	0	0	0
	PEDESTAL OFFSET	OFF	OFF	OFF	OFF	OFF	OFF
GAMMA MODE		HD	HD	HD	HD	FILMLIKE 3	HLG
GAMMA SETTING	MASTER GAMMA	0.45	0.45	0.45	0.45	0.45	0.45
	F-REC DYNAMIC LVL	600%	600%	600%	600%	600%	600%
	F-REC BLACK STR LVL	0%	0%	0%	0%	0%	0%
	V-REC KNEE SLOPE	500%	500%	500%	500%	500%	500%
	V-REC KNEE POINT	30%	30%	30%	30%	30%	30%
	BLACK GAMMA	0	0	-4	6	0	0
	B.GAMMA RANGE	1	1	2	2	1	1
KNEE SETTING	KNEE MODE	AUTO	AUTO	AUTO	AUTO	AUTO	AUTO
	A.KNEE RESPONSE	4	4	4	4	4	4
	KNEE POINT	93.0%	93.0%	93.0%	93.0%	93.0%	93.0%
	KNEE SLOPE	99	99	99	99	99	99
	HLG KNEE SW	OFF	OFF	OFF	OFF	OFF	OFF
	HLG KNEE POINT	55	55	55	55	55	55
	HLG KNEE SLOPE	10	10	10	10	10	10
WHITE CLIP	WHITE CLIP	ON	ON	ON	ON	ON	ON
	WHITE CLIP LEVEL	109%	109%	109%	109%	109%	109%
DRS		OFF	OFF	OFF	OFF	OFF	OFF
DRS EFFECT DEPTH		1	1	1	1	1	1
DNR		1	1	1	1	1	1
A.IRIS LEVEL		ON	ON	ON	ON	ON	ON
A.IRIS LEVEL EFFECT		0	0	0	0	0	0

6-3. Output signals (SDI)

Selectable video output format on SDI terminal varies depending on settings below.



MENU > SYSTEM > FREQUENCY
MENU > SYSTEM > REC FORMAT
MENU > VIDEO OUT/LCD/VF > HDMI OUT > OUT FORMAT

FREQUENCY	Menu item		Output video format (Factory default underlined)
	REC FORMAT		
	RESOLUTION	FRAME RATE	
59.94Hz	3840x2160	59.94p	1920x1080 59.94p, <u>1920x1080 59.94i</u>
		29.97p	1920x1080 29.97PsF
		23.98p	1920x1080 23.98PsF
	1920x1080	59.94p	1920x1080 59.94p, <u>1920x1080 59.94i</u> , 720x480 59.94i
		59.94i	<u>1920x1080 59.94i</u> , 720x480 59.94i
		29.97p	<u>1920x1080 29.97p</u> , 720x480 59.94i
		23.98p	<u>1920x1080 23.98p</u> , 720x480 59.94i
	1280x720	59.94p	<u>1280x720 59.94p</u> , 720x480 59.94i
	720x480	59.94i	720x480 59.94i
	50.00Hz	3840x2160	50.00p
25.00p			1920x1080 25.00PsF
1920x1080		50.00p	1920x1080 50.00p, <u>1920x1080 50.00i</u> , 720x576 50.00i
		50.00i	<u>1920x1080 50.00i</u> , 720x576 50.00i
		25.00p	<u>1920x1080 25.00PsF</u> , 720x576 50.00i
1280x720		50.00p	<u>1280x720 50.00p</u> , 720x576 50.00i
720x576		50.00i	720x576 50.00i

6-4. Output signals (HDMI)

Selectable video output format on HDMI terminal varies depending on settings below.

HDMI

MENU > SYSTEM > FREQUENCY
MENU > SYSTEM > REC FORMAT
MENU > VIDEO OUT/LCD/VF > HDMI OUT > OUT FORMAT

FREQUENCY	Menu item		Output video format (Factory default underlined)
	REC FORMAT		
	RESOLUTION	FRAME RATE	
59.94Hz	3840x2160	59.94p	3840x2160 59.94p, 3840x2160 59.94p (4:2:0/8bit), <u>1920x1080 59.94p</u> , 1920x1080 59.94i
		29.97p	3840x2160 29.97p, <u>1920x1080 29.97p</u>
		23.98p	3840x2160 23.98p, <u>1920x1080 23.98p</u>
	1920x1080	59.94p	<u>1920x1080 59.94p</u> , 1920x1080 59.94i
		59.94i	1920x1080 59.94i
		29.97p	1920x1080 29.97p
		23.98p	1920x1080 23.98p
	1280x720	59.94p	1280x720 59.94p
	720x480	59.94i	720x480 59.94p
	50.00Hz	3840x2160	50.00p
25.00p			3840x2160 25.00p, <u>1920x1080 25.00p</u>
1920x1080		50.00p	<u>1920x1080 50.00p</u> , 1920x1080 50.00i
		50.00i	1920x1080 50.00i
		25.00p	1920x1080 25.00p
1280x720		50.00p	1280x720 50.00p
720x576		50.00i	720x576 50.00p

6-5. Streaming format (Protocol RTMP)

MENU > NETWORK > STREAMING > STREAMING FORMAT

Menu item		Output video format (Factory default underlined)
FILE FORMAT	REC FORMAT	
MOV	UHD	Not available
	1080/50p	1920x1080-50fps 24M, 1920x1080-50fps 20M, 1920x1080-50fps 16M, 1280x720-50fps 14M, 1280x720-50fps 8M, 1280x720-50fps 3M, 640x360-25fps 4M, 640x360-25fps 1.5M, <u>640x360-25fps 0.7M</u> , 320x180-25fps 4M, 320x180-25fps 1.5M, 320x180-25fps 0.5M
	1080/59.94p	1920x1080-60fps 24M, 1920x1080-60fps 20M, 1920x1080-60fps 16M, 1280x720-60fps 14M, 1280x720-60fps 8M, 1280x720-60fps 3M, 640x360-30fps 4M, 640x360-30fps 1.5M, <u>640x360-30fps 0.7M</u> , 320x180-30fps 4M, 320x180-30fps 1.5M, 320x180-30fps 0.5M
	1080/50i 1080/25p	1920x1080-25fps 14M, 1920x1080-25fps 6M, 1920x1080-25fps 1M, 1280x720-25fps 8M, 1280x720-25fps 2M, 1280x720-25fps 1M, 640x360-25fps 4M, 640x360-25fps 1.5M, <u>640x360-25fps 0.7M</u> , 320x180-25fps 4M, 320x180-25fps 1.5M, 320x180-25fps 0.5M
	1080/60i 1080/29.97p	1920x1080-30fps 14M, 1920x1080-30fps 6M, 1920x1080-30fps 1M, 1280x720-30fps 8M, 1280x720-30fps 2M, 1280x720-30fps 1M, 640x360-30fps 4M, 640x360-30fps 1.5M, <u>640x360-30fps 0.7M</u> , 320x180-30fps 4M, 320x180-30fps 1.5M, 320x180-30fps 0.5M
	1080/23.98p	1920x1080-24fps 14M, 1920x1080-24fps 6M, <u>1920x1080-24fps 1M</u>
AVCHD	All	Not available
P2	720/59.94p	1280x720-60fps 14M, 1280x720-60fps 8M, 1280x720-60fps 3M, 640x360-30fps 4M, 640x360-30fps 1.5M, <u>640x360-30fps 0.7M</u> , 320x180-30fps 4M, 320x180-30fps 1.5M, 320x180-30fps 0.5M
	720/50.00p	1280x720-50fps 14M, 1280x720-50fps 8M, 1280x720-50fps 3M, 640x360-25fps 4M, 640x360-25fps 1.5M, <u>640x360-25fps 0.7M</u> , 320x180-25fps 4M, 320x180-25fps 1.5M, 320x180-25fps 0.5M

6-6. Streaming format (Protocol NDI | HX)

MENU > NETWORK > NDI | HX > STREAMING FORMAT



Menu item		Output video format (Factory default underlined)
FILE FORMAT	REC FORMAT	
MOV	UHD	Not available
	1080/50p	1920x1080-50fps 24M, 1920x1080-50fps 16M, <u>1920x1080-50fps 10M</u> , 1920x1080-50fps 8M, 1280x720-50fps 14M, 1280x720-50fps 10M, 1280x720-50fps 6M
	1080/59.94p	1920x1080-60fps 24M, 1920x1080-60fps 16M, <u>1920x1080-60fps 10M</u> , 1920x1080-60fps 8M, 1280x720-60fps 14M, 1280x720-60fps 10M, 1280x720-60fps 6M
	1080/50i 1080/25p	1920x1080-25fps 14M, <u>1920x1080-25fps 10M</u> , 1920x1080-25fps 6M,, 1280x720-25fps 8M, 1280x720-25fps 4M, 1280x720-25fps 2M
	1080/60i 1080/29.97p	1920x1080-30fps 14M, <u>1920x1080-30fps 10M</u> , 1920x1080-30fps 6M,, 1280x720-30fps 8M, 1280x720-30fps 4M, 1280x720-30fps 2M
	1080/23.98p	Not available
AVCHD	All	Not available
P2	720/59.94p	1280x720-60fps 14M, <u>1280x720-60fps 10M</u> , 1280x720-60fps 6M
	720/50.00p	1280x720-50fps 14M, <u>1280x720-50fps 10M</u> , 1280x720-50fps 6M

6-7. Error and warning system

SYSTEM ERROR

Screen display Camera image screen	Description	Behavior and cause
[SYSTEM ERROR]	An error in the standard signal or communication error has occurred.	All the tally lamps and the card access lamps (orange) will flash four times a second, and an alarm is sounded. <ul style="list-style-type: none"> • Set the power to < ⏻ > (standby).

WARNING

Screen display Camera image screen	Description	Behavior and cause
[LOW BATTERY]	Remaining battery level is insufficient.	All the tally lamps and the card access lamps (orange) will flash four times a second, and an alarm is sounded. The power status display becomes  , and it will flash once every second in red. <ul style="list-style-type: none"> • The power is turned off in approximately five seconds. • Replace with a fully charged battery, or connect the AC adaptor.
[HIGH TEMPERATURE]	Displayed when the internal temperature of the camera has risen above assumed.	All the tally lamps and the card access lamps (orange) will flash four times a second, and an alarm is sounded. <ul style="list-style-type: none"> • The power is turned off in approximately five seconds. • Turn on the power again and check recording and playback operations. If the problem persists, consult the dealer.
[REC WARNING]	An error of the recording data has occurred during recording, and the recording has stopped.	All the tally lamps and the card access lamps (orange) will flash four times a second, and an alarm is sounded. <ul style="list-style-type: none"> • Recording is stopped.
	It has tried to record exceeding the maximum number of clips during recording.	All the tally lamps and the card access lamps (orange) will flash four times a second, and an alarm is sounded. <ul style="list-style-type: none"> • Recording is stopped. • [REC WARNING] [-<OVER MAX NUM. OF CLIPS->] is displayed in the warning display field of the STATUS screen for the mode check. • Replace the memory card or delete unnecessary clips.
[CARD ERROR <SLOT 1->][CARD ERROR <SLOT 2->]	A data error caused by the memory card has occurred during recording or playback.	<ul style="list-style-type: none"> • When it was recording All the tally lamps and the card access lamps (orange) will flash four times a second, and an alarm is sounded. Recording is stopped. The memory card where the error has occurred is write protected after recording stops. Replace the memory card in the card slot where the error has occurred. • When it was playing back Playback is stopped.
[END] (Memory card status display)	The remaining recording capacity of the memory card has exhausted during recording.	All the tally lamps and the card access lamps (orange) will flash four times a second, and an alarm is sounded. <ul style="list-style-type: none"> • Recording is stopped. • Replace the memory card or delete unnecessary clips.
 (Once every second, flash in red)	Battery is almost consumed.	All the tally lamps will flash once every second. <ul style="list-style-type: none"> • The current operation will continue. • Replace with a fully charged battery, or connect the AC adaptor.
Remaining recording capacity display of the memory card (Flashes once every second during recording)	The remaining recording capacity of the memory card is getting low.	<ul style="list-style-type: none"> • Recording will continue. • Replace the memory card as necessary.

6-7. Error and warning system (continued)

ALERT

Screen display	Description	Behavior and cause
Camera image screen		
[SIMUL REC WARNING <SLOT 1>]/ [SIMUL REC WARNING <SLOT 2>]	An error has occurred in one of the memory cards during simultaneous recording.	A message is displayed for approximately five seconds. • Recording to the other memory card will continue.
[SIMUL REC WARNING <SLOT 1>]/ [SIMUL REC WARNING <SLOT 2>]	Recording has been attempted while the number of clips has exceeded the limit on one of the memory cards during simultaneous recording.	A message is displayed for approximately five seconds. • Recording to the other memory card will continue. • [SIMUL REC WARNING <SLOT 1>] [<OVER MAX NUM. OF CLIPS>]/[SIMUL REC WARNING <SLOT 2>] [<OVER MAX NUM. OF CLIPS>] is displayed in the warning display field of the STATUS screen for the mode check. • Replace the memory card or delete unnecessary clips.
[BACKGROUND REC WARNING <SLOT 1>]/[BACKGROUND REC WARNING <SLOT 2>]	An error has occurred in one of the memory cards during background recording.	A message is displayed for approximately five seconds. • Recording to the other memory card will continue.
[BACKGROUND REC WARNING <SLOT 1>]/[BACKGROUND REC WARNING <SLOT 2>]	Recording has been attempted while the number of clips has exceeded the limit on one of the memory cards during background recording.	A message is displayed for approximately five seconds. • Recording to the other memory card will continue. • [BACKGROUND REC WARNING <SLOT 1>] [<OVER MAX NUM. OF CLIPS>]/[BACKGROUND REC WARNING <SLOT 2>] [<OVER MAX NUM. OF CLIPS>] is displayed in the warning display field of the STATUS screen for the mode check. • Replace the memory card or delete unnecessary clips.
[FAN STOPPED]	The fan has stopped.	A message is displayed. • The current operation will continue. • Stop the use immediately when the fan has stopped, and consult the dealer. • If the fan has stopped, temperature of the camera will rise. Therefore, do not use the camera for a long period of time.
[CHECK CARD <SLOT 1>]/[CHECK CARD <SLOT 2>]	The memory card cannot be recognized properly because a recording medium which is not supported has been inserted or there is dirt on the terminal of the memory card.	A message is displayed for approximately five seconds. • Check the memory card that is inserted. • Insert the memory card again if displayed when inserting a memory card.
[FORMAT ERROR CARD <SLOT 1>]/ [FORMAT ERROR CARD <SLOT 2>]	A memory card with management information out of specifications has been inserted. (Include when the system frequency (59.94 Hz system or 50.00 Hz system) for the AVCHD format of the memory card is different from the setting in the [SYSTEM] menu → [FREQUENCY])	A message is displayed for approximately five seconds. • Insert a memory card that can record. • The system frequency information for the AVCHD format is confirmed at the time of formatting or at the first recording.
[NOT SDXC CARD <SLOT 1>]/[NOT SDXC CARD <SLOT 2>]	A SDHC memory card that cannot record the MOV format data or a 32 GB microSD card is inserted when [FILE FORMAT] is set to MOV format.	A message is displayed for approximately five seconds. • Insert a SDXC memory card or 64 GB microSD card.
[INCOMPATIBLE CARD <SLOT 1>]/ [INCOMPATIBLE CARD <SLOT 2>]	A memory card that may not be able to record due to slow writing speed has been inserted.	A message is displayed for approximately five seconds. • The current operation will continue. • Use a memory card with sufficient writing speed.
[BACKUP BATT EMPTY]	Voltage lowering of the backup battery for internal clock was detected when the power is set to < > (ON).	A message is displayed for approximately five seconds. • The current operation will continue. • Set the date/time again after charging the built-in battery.

6-7. Error and warning system (continued)

MESSAGE

Screen display	Description	Behavior and cause
Camera image screen		
[CANNOT PLAY.]	This is a clip that cannot be played back. (When it cannot be played back due to difference of the system frequency, etc.) An error has occurred during playback, and the playback has stopped.	A message is displayed. • Confirm if the system frequency of the clip is the same as the system frequency of the camera. • Check the clip.
[CANNOT DELETE.]	This is a clip that cannot be deleted.	A message is displayed. • Match the device and content versions.
[CANNOT RECORD. THE NUMBER OF CLIPS HAS EXCEEDED THE MAXIMUM LIMIT.]	The number of clips that can be recorded has reached the maximum.	A message is displayed. • Replace the memory card or delete unnecessary clips.
[CARD ERROR. PLEASE REFORMAT.]	Formatting of the memory card has failed.	A message is displayed. • Format it again.
[Repair failed.]	Repairing the clip where an error occurred has failed because the power was disconnected or the memory card was removed during recording. Restoring of the management information has failed.	A message is displayed. • Check the memory card.
[UNABLE TO FORMAT.]	This memory card cannot be formatted.	A message is displayed. • Check the memory card.
[CANNOT REPAIR CONTROL INFORMATION DUE TO LOW BATTERY POWER.]	Management information cannot be restored due to insufficient remaining battery level.	A message is displayed. • Replace with a fully charged battery, or connect the AC adaptor.
[CANNOT PROTECT.]	This is a clip that cannot be protected.	A message is displayed. • Match the device and content versions.
[THE CLIP IS PROTECTED. PLEASE CANCEL PROTECTION.]	The clip is protected so it cannot be deleted.	A message is displayed. • Cancel the protect on the clip.
[CANNOT DELETE UNTIL TOP MENU IS DELETED. DELETE TOP MENU? (RECORDED DATA WILL NOT BE DELETED)]	The camera is trying to delete a clip on the memory card where the top menu has been created.	A message is displayed. • Delete the top menu.
[CANNOT RECORD UNTIL TOP MENU IS DELETED. DELETE TOP MENU? (RECORDED DATA WILL NOT BE DELETED)]	The memory card where the top menu was created has been inserted.	A message is displayed. • Delete the top menu.
[THUMBNAIL DATA ERROR IS DETECTED.]	An error occurred in the thumbnail information of the memory card.	A message is displayed. • Restoring of the management information is performed automatically after this.
[CANNOT RECORD - INCOMPATIBLE CONTROL DATA.]	The version of the management information on the memory card is not supported.	A message is displayed. • Match the device and content versions.
[CANNOT SET.]	This cannot be set.	A message is displayed. • Perform the setting after making it possible to set.
[THIS CLIP CANNOT BE COPIED.]	The clip cannot be copied.	A message is displayed. • Copy the clips other than the corresponding clip.
[CONTROL DATA ERROR HAS BEEN DETECTED. (SD CARD)]	An error occurred in the management information of the memory card.	A message is displayed. • Restoring of the management information is performed automatically after this.
[COPY FAILED. PLEASE CHECK THE CARD.]	The clip has failed to copy due to an error in the memory card.	A message is displayed. • Check the memory card.

6-7. Error and warning system (continued)

MESSAGE

Screen display Camera image screen	Description	Behavior and cause
[COPY TERMINATION IN PROGRESS DUE TO INSUFFICIENT BATTERY POWER. DO NOT SWITCH OFF.]	Remaining battery level became low while copying the clip.	A message is displayed. <ul style="list-style-type: none"> • The copy is canceled. • Replace with a fully charged battery, or connect the AC adaptor.
[COPY TERMINATED DUE TO INSUFFICIENT BATTERY POWER.]	Copying of a clip is canceled due to insufficient remaining battery level.	A message is displayed. <ul style="list-style-type: none"> • Replace with a fully charged battery, or connect the AC adaptor.
[CANNOT COPY - THE NUMBER OF CLIPS HAS REACHED MAXIMUM.]	The number of clips that can be copied has reached the maximum.	A message is displayed. <ul style="list-style-type: none"> • Replace the memory card in the copy destination or delete unnecessary clips.
[LOW BATTERY. PLEASE CONNECT AC ADAPTOR OR CHANGE BATTERY.]	It is trying to copy a clip or update the camera firmware while the remaining battery level is insufficient.	A message is displayed. <ul style="list-style-type: none"> • Replace with a fully charged battery, or connect the AC adaptor.
[CANNOT PLAY THIS CLIP ON THIS MODEL.]	This is a clip that cannot be played back with the camera.	A message is displayed. <ul style="list-style-type: none"> • Playback on a device that can playback.
[Cannot copy: contains recordings from other devices.]	The clip recorded in other device cannot be copied.	A message is displayed. <ul style="list-style-type: none"> • Copy the clips other than the corresponding clip.
[ERROR HAS OCCURRED. TO REPAIR THE CONTROL DATA, PLEASE CONNECT AC ADAPTOR OR CHANGE BATTERY.]	The remaining battery level was low when the restoring of the management information is started.	A message is displayed. <ul style="list-style-type: none"> • Replace with a fully charged battery, or connect the AC adaptor.
[INVALID]	Operation is disabled.	A message is displayed. <ul style="list-style-type: none"> • Operate after the the operation becomes enabled.

6-7. Error and warning system (continued)

MESSAGE

Screen display	Description	Behavior and cause
Camera image screen		
[Cannot record - Playlist capacity is full.]	The camera tried to record on a memory card where the number of playlists for recording has reached the maximum.	A message is displayed. • Replace the memory card or delete unnecessary clips.
[Cannot copy - Playlist capacity is full.]	The camera tried to copy to a memory card where the number of playlists for recording has reached the maximum.	A message is displayed. • Replace the memory card or delete unnecessary clips.
[Exceeds capacity. Please reselect.]	The remaining recording capacity of the memory card for the copy destination is insufficient.	A message is displayed. • Select the clip to copy again, or secure enough space in the remaining recording capacity on the memory card for the copy destination.
[Check the destination media.]	An error has occurred on the memory card for the copy destination while copying.	A message is displayed. • Confirm the memory card for the copy destination.
[SCENE FILE LOAD FAILED]	Loading of the scene file has failed.	A message is displayed. • Check the memory card.
[SCENE FILE WRITE FAILED]	Writing of the scene file has failed.	A message is displayed. • Check the memory card.
[DISCONNECT USB CABLE.]	Due to an OS non-compatible error, five minutes has elapsed until the service mode connection is established.	A message is displayed. • Confirm if the OS in use is supported by the camera.
[CARD LOCKED.]	The camera tried to protect or delete a clip on a memory card that has been locked. The camera tried to copy a clip to the memory card that has been locked.	A message is displayed. • Unlock the memory card.
[CANNOT SELECT MORE CLIPS.]	It has tried to select more than 99 clips.	A message is displayed. • Execute the process such as copying by every 99 clips.
[SELECT THE CLIP TO BE DELETED.]	It has tried to delete a clip without choosing any.	A message is displayed. • Select a clip to be deleted.
[SELECT THE CLIPS TO COPY]	It has tried to copy a clip without choosing any.	A message is displayed. • Select a clip to be copied.
[Insert a card in slot 1.]	Copying was tried to be executed without inserting a memory card into card slot 1.	A message is displayed. • Insert a memory card into card slot 1.
[Insert a card in slot 2.]	Copying was tried to be executed without inserting a memory card into card slot 2.	A message is displayed. • Insert a memory card into card slot 2.
[CHECK CARD.]	It has tried to copy to an error card.	A message is displayed. • Check the memory card.
[CANNOT COPY.]	Copying was attempted while the system frequency (59.94 Hz and 50.00 Hz) of the memory card to copy from and the memory card to copy to are different for content recorded in AVCHD format.	A message is displayed. • Set the same system frequency (59.94 Hz system or 50.00 Hz system) for the content of the memory card to copy from and the memory card to copy to. • The system frequency information for the AVCHD format is confirmed at the time of formatting or at the first recording.
[CANNOT RECORD.]	Cannot be recorded.	A message is displayed. • Perform recording after making it possible.
[REC PAUSE INVALID]	The camera tried to stop the next recording before the previous recording finished writing to the memory card.	A message is displayed. • Stop recording after writing to the memory card is complete. Recording can be stopped after the message that is displayed disappears.
[WRITE PROTECTED]	The memory card has been write-protected.	A message is displayed. • Insert a memory card with write access.

6-8. Genuine accessories

MIC HOLDER
Part No. 1YP1PX270T8Z





EYE CUP
Part No. SYA0048

LENS HOOD
Part No. 6YP4AGCX350Z



Accessory mounting
screws
M3 size, 6mm in length
Part No. XSB3+6FJK

Grip belt, Part No. SYQ0833

AC adaptor	Shoulder belt
 <p>Part No. SAE0011AJ</p>	 <p>Part No. VFC4897</p>

* Part number and design are subject to change without notice.

Optional accessory

Battery pack (AG-VBR batteries support quick charging with AG-BRD50 quick charger)



AG-VBR118G
(11,800mAh)



AG-VBR89G
(8,850mAh)



AG-VBR59
(5,900mAh)



VW-VBD58
(5,800mAh)

Battery charger



AG-BRD50
(Support quick charging with
AG-VBR batteries)

Microphone



AJ-MC200G
(+48V, XLR)

* Part number and design are subject to change without notice.

6-9. Specification

General	
Power:	DC 7.28 V (when the battery is used) DC 12 V (when the AC adaptor is used)
Power Consumption:	17 W (when the LCD monitor is used) 11.5 W (1080i / 422ALL-I 100M recording, when the LCD monitor is used, no external device connection)
Operating Temperature:	0 °C to 40 °C (32 °F to 104 °F)
Operating Humidity:	10 % to 80 % (no condensation)
Weight:	Body: approx. 1.9 kg (4.19 lb) (body only, excluding lens hood, battery, and accessories) Shooting: approx. 2.3 kg (5.07 lb) (including lens hood, battery, and microphone holder)
Dimensions:	180 mm (W) x 173 mm (H) x 311 mm (D) (7-1/8 inches x 6-13/16 inches x 12-1/4 inches) (excluding protrusion and eye cup)
Camera Unit	
Pickup Device:	1.0-type (effective size) MOS solid state image sensor
Effective Pixels:	15,030,000 pixel
Lens:	Optical image stabilizer lens, optical 20x motorized zoom F value: F2.8 to F4.5 Focal length: f=8.8 mm to 176 mm 35 mm equivalent: 24.5 mm to 490 mm Filter Diameter: 67 mm ND Filter: Clear, 1/4, 1/16, 1/64 IR Filter: Incorporates the ON/OFF control function Shortest Shooting Distance (M.O.D.): Approx. 10 cm (W), 1.0 m (T) from the front lens
Gain Setting:	L/M/H selector switch -3 dB to 18 dB (Adjustable in 1 dB steps) 24 dB, 30 dB, 36 dB switched (when assigning [S. GAIN] to the USER button)
Color Temperature Setting:	ATW, ATW LOCK, A ch, B ch, preset 3200 K/preset 5600 K/VAR (2000 K to 15000 K)

Camera Unit

<p>Shutter Speed:</p>	<p>When [SYSTEM MODE] = 59.94 Hz</p> <ul style="list-style-type: none"> • 59.94i/59.94p mode: 1/60 sec. (shutter off), 1/100 sec., 1/120 sec., 1/250 sec., 1/500 sec., 1/1000 sec., 1/2000 sec., 1/4000 sec., 1/8000 sec., 1/10000 sec. • 29.97p mode: 1/30 sec., 1/50 sec. (shutter off), 1/60 sec., 1/100 sec., 1/120 sec., 1/250 sec., 1/500 sec., 1/1000 sec., 1/2000 sec., 1/4000 sec., 1/8000 sec., 1/10000 sec. • 23.98p mode: 1/24 sec., 1/48 sec., 1/50 sec. (shutter off), 1/60 sec., 1/100 sec., 1/120 sec., 1/250 sec., 1/500 sec., 1/1000 sec., 1/2000 sec., 1/4000 sec., 1/8000 sec., 1/10000 sec. <p>When [SYSTEM MODE] = 50.00 Hz</p> <ul style="list-style-type: none"> • 50i/50p mode: 1/50 sec. (shutter off), 1/60 sec., 1/100 sec., 1/120 sec., 1/250 sec., 1/500 sec., 1/1000 sec., 1/2000 sec., 1/4000 sec., 1/8000 sec., 1/10000 sec. • 25p mode: 1/25 sec., 1/50 sec. (shutter off), 1/60 sec., 1/100 sec., 1/120 sec., 1/250 sec., 1/500 sec., 1/1000 sec., 1/2000 sec., 1/4000 sec., 1/8000 sec., 1/10000 sec.
<p>Shutter Speed: (Slow Shutter)</p>	<p>When [SYSTEM MODE] = 59.94 Hz</p> <ul style="list-style-type: none"> • 59.94i/59.94p mode: 1/1 sec., 1/2 sec., 1/4 sec., 1/6 sec., 1/15 sec., 1/30 sec. • 29.97p mode: 1/1 sec., 1/2 sec., 1/4 sec., 1/6 sec., 1/15 sec. • 23.98p mode: 1/1 sec., 1/2 sec., 1/4 sec., 1/6 sec., 1/12 sec. <p>When [SYSTEM MODE] = 50.00 Hz</p> <ul style="list-style-type: none"> • 50i/50p mode: 1/1 sec., 1/2 sec., 1/4 sec., 1/6 sec., 1/12 sec., 1/25 sec. • 25p mode: 1/1 sec., 1/2 sec., 1/4 sec., 1/6 sec., 1/12 sec.
<p>Shutter Speed: (Synchro Scan)</p>	<p>When [SYSTEM MODE] = 59.94 Hz</p> <ul style="list-style-type: none"> • 59.94i/59.94p mode: 1/60.0 sec. to 1/7200 sec. • 29.97p mode: 1/30.0 sec. to 1/7200 sec. • 23.98p mode: 1/24.0 sec. to 1/7200 sec. <p>When [SYSTEM MODE] = 50.00 Hz</p> <ul style="list-style-type: none"> • 50i/50p mode: 1/50.0 sec. to 1/7200 sec. • 25p mode: 1/25.0 sec. to 1/7200 sec.
<p>Shutter Open Angle:</p>	<p>3.0 deg to 180.0 deg to 360.0 deg (in 0.5 deg steps)</p>
<p>VFR Recording Frame Rate:</p>	<p>When [SYSTEM MODE] = 59.94 Hz</p> <p>1, 2, 4, 6, 9, 12, 15, 18, 20, 21, 22, 24, 25, 26, 27, 28, 30, 32, 34, 36, 40, 44, 48, 54, 60 (fps)</p> <p>When [SYSTEM MODE] = 50.00 Hz</p> <p>1, 2, 4, 6, 9, 12, 15, 18, 20, 21, 22, 23, 24, 25, 26, 27, 28, 30, 32, 34, 37, 42, 45, 48, 50 (fps)</p>

Camera Unit

VFR Recording Frame Rate:	When [SYSTEM MODE] = 59.94 Hz 1, 2, 4, 6, 9, 12, 15, 18, 20, 21, 22, 24, 25, 26, 27, 28, 30, 32, 34, 36, 40, 44, 48, 54, 60 (fps) When [SYSTEM MODE] = 50.00 Hz 1, 2, 4, 6, 9, 12, 15, 18, 20, 21, 22, 23, 24, 25, 26, 27, 28, 30, 32, 34, 37, 42, 45, 48, 50 (fps)
Super Slow Recording:	When [SYSTEM MODE] = 59.94 Hz 1920 x 1080 (FHD): shooting frame rate 120 fps When [SYSTEM MODE] = 50.00 Hz 1920 x 1080 (FHD): shooting frame rate 100 fps
Sensitivity:	When [HIGH SENS.] mode F12 (2000 lx, 3200 K, 89.9 % reflect, 2160/59.94p, 1080/59.94i) F13 (2000 lx, 3200 K, 89.9 % reflect, 2160/50p, 1080/50i)
Horizontal Resolution:	2000 TV or higher (UHD: center) 1000 TV or higher (FHD: center)
i.Zoom:	x 32 (FHD), x 24 (UHD)
Digital Zoom:	x 2/ x 5/ x 10
Lens Hood:	Hood with lens cover

Memory Card Recorder

Recording Media:	SDHC memory card (4 GB to 32 GB), SDXC memory card (32 GB to 128 GB) UHS-I/UHS-II UHS Speed Class 3 supported, Video Speed Class V90 supported microP2 card (A series, B series) See " Available Memory Card " table for the details.
Recording Slot:	microP2/SDXC UHS-II card slot x 2
Recording Pixels:	3840 x 2160 (UHD), 1920 x 1080 (FHD), 1280 x 720 (HD), 720 x 480(SD), 720 x 576 (SD)
System Frequency:	59.94 Hz/50.00 Hz
Recording File Format:	MOV (AVC), MOV (HEVC), AVCHD, P2 MXF
Recording Format:	See " Recording Format " table for the details.
Recording Time:	See " Recording Time " table for the details.
2 Slot Functions:	Relay Rec, Simultaneous Rec, Background Rec
Special Recording Functions:	Pre Rec, Interval Rec, Time Stamp

Digital Video

Quantization: MOV: 4:2:2 10 bit/4:2:0 8 bit/4:2:0 10 bit (HEVC)
AVCHD: 4:2:0 8 bit
P2: 4:2:2 10 bit/4:2:0 8 bit (AVC-LongG12)

Video Compression Format: MOV: H.264/MPEG-4 AVC High Profile
H.265/MPEG-H HEVC Main10 Profile
P2: AVC-Intra422/AVC-LongG50/AVC-LongG25/
AVC-LongG12: MPEG-4 AVC/H.264 High Profile

Digital Audio

Recording Audio Signal: MOV: 48 kHz/24 bit, 2 ch, Linear PCM
AVCHD: 48 kHz/16 bit, 2 ch, Dolby Audio™
P2: 48 kHz/24 bit, 4 ch, Linear PCM
(In AVC-LongG12, 48 kHz/16 bit, 4 ch)

Headroom: 12 dB/18 dB/20 dB switchable (menu)

Live Streaming

Video Compression Format: H.264/MPEG-4 AVC Main Profile, High Profile

Video Resolution: 1920 x 1080 (FHD), 1280 x 720 (HD), 640 x 360, 360 x 180

Streaming Method: Unicast, Multicast

Frame Rate: System frequency = 59.94 Hz: 30 fps, 60 fps
System frequency = 50.00 Hz: 25 fps, 50 fps

Bit Rate: 24 Mbps, 20 Mbps, 16 Mbps, 14 Mbps, 8 Mbps,
6 Mbps, 4 Mbps, 3 Mbps, 2 Mbps, 1.5 Mbps,
1 Mbps, 0.7 Mbps, 0.5 Mbps

Audio Compression Format: AAC-LC, 48 kHz/16 bit, 2 ch

Network Protocol: RTSP/RTP/RTMP/RTMPS

Video Output

SDI OUT:	<p>BNC x 1, SDI REC REMOTE supported HD: 0.8 V [p-p], 75 Ω SD: 0.8 V [p-p], 75 Ω, Output format (4:2:2 10 bit):</p> <ul style="list-style-type: none"> • 1920 x 1080: 59.94p, 50p, 59.94i, 50i, 29.97Psf, 25Psf, 23.98Psf • 1280 x 720: 59.94p, 50p • 720 x 480: 59.94i • 720 x 576: 50i
HDMI OUT :	<p>HDMI x 1, Type A, HDMI REC REMOTE supported, VIERA Link not supported Output format (4:2:2 10 bit):</p> <ul style="list-style-type: none"> • 3840 x 2160: 59.94p, 50p, 29.97p, 25p, 23.98p • 1920 x 1080: 59.94p, 50p, 59.94i, 50i, 29.97p, 25p, 23.98p • 1280 x 720: 59.94p, 50p • 720 x 480: 59.94p • 720 x 576: 50p
VIDEO OUT:	3.5 mm diameter mini jack, composite 1.0 V [p-p], 75 Ohm

Audio Input / Output

Built-in Microphone:	Stereo microphone
Input 1/2:	<p>XLR (3-pin) x 2 (INPUT1, INPUT2) Input high impedance, LINE/MIC/MIC+48V (switchable SW) MIC: -40 dBu/-50 dBu/-60 dBu (switchable menu) LINE: +4 dBu/0 dBu (switchable menu)</p>
SDI OUT:	Linear PCM 4 ch
HDMI OUT:	Linear PCM 2 ch
Headphone:	3.5 mm diameter stereo mini jack x 1
AV OUT:	3.5 mm diameter stereo mini jack x 1, Output level: 600 Ohm, 316 mV
Speaker:	20 mm diameter, round x 1

Other Input / Output

TC IN/OUT:	BNC x 1, Used as the input and output terminals (switchable menu) Input: 1.0 V to 4.0 V [p-p] 10 kΩ Output: 2.0 V ± 0.5 V [p-p] low impedance
REMOTE:	2.5 mm diameter super mini jack
LAN:	RJ-45: 1000BASE-T/100BASE-TX/10BASE-T NDI HX supported* *To use this function, an activation key code from NewTek is required. Key codes can be purchased from the following website: http://new.tk/ndi_panasonic
USB 2.0 HOST:	Type-A, 4-pin (5 V, 0.5 A) for Wireless Module (option)
USB 3.0 DEVICE:	USB 3.1 GEN1 Type-C, USB Mass storage function No USB bus power function
DC IN 12V:	DC 12 V EIAJ Type 4

Monitor / Viewfinder

LCD Monitor:	3.5 type TFT LCD color monitor (3:2), approx. 1,620,000 dots, Touch panel video display (16: 9) area: Approx. 1,370,000 dots
Viewfinder:	0.39 type OLED (organic EL display), approx. 2,360,000 dots, video display (16: 9) area: approx. 1,770,000 dots
Included Accessories	
Battery (AG-VBR59), Battery charger (AG-BRD50), AC adaptor, AC cable, Microphone holder kit, Shoulder strap, Eye cup, Lens hood*, Grip belt* and Operating instructions (Items marked by an asterisk (*) come already attached to the camera)	

6-10. Dimensions

Unit: mm

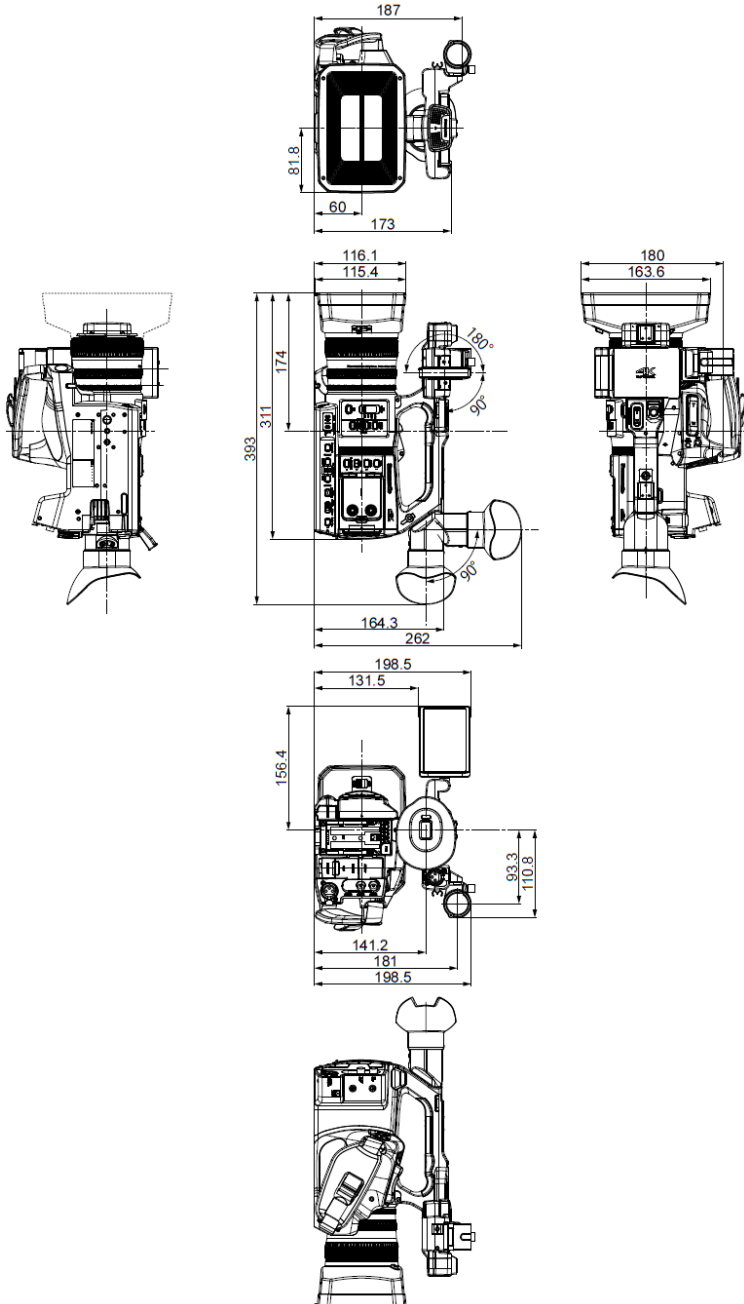

Revision History

Issued	History	Document Version
Dec 2019	First edition issued	v1.00E

Panasonic

Panasonic Corporation

Download firmware, check frequently asked questions for the AG-CX350 at
https://panasonic.biz/cns/sav/pass_e