

! Instructions:

1. Mount the lighting on a light stand with a suitable direction, unfold the barn doors and then connect with power. If power is standalone Li-ion battery, please check if the standalone Li-ion battery is securely installed onto the battery plate and in normal condition before use.
This series of lightings can be matched with LEDGO 2.4G remote controller for remote control(bought additionally if needed).

2. LG-600SC. LG-900SCLG-1200SC.Please insert diffuser or filter from upside
(As below pictures).

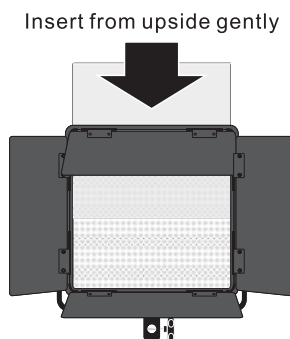

3. Switch on and dim according to different shooting conditions. Light direction can be adjusted through the two clamping screws that fix the panel with the U-bracket.
4. Switch off after use.

? Notice:

1. Dampness causes a shot circuit. Please place the product where it is dry and ventilated.
2. Please turn off after use, so as to avoid waste of battery power and longtime heat generation, and further shorten the service life of the LED lamps.
3. Li-ion battery should be recharged in time.
4. Please install Li-ion battery as gently as possible to avoid damage and distortion of the battery plate.

LEDGO TECHNOLOGY LIMITED

Add:Zhanglin Section,Highway324,Dongli,Chenghai,Shantou City,Guangdong Province,China
Tel:0086-754-85354187 Fax:0086-754-85300887
E-mail:info@ledgo.hk http://www.ledgo.hk

LG-600SC.LG-900SC.LG-1200SC Studio LED Light

Instruction Sheet

Extra Parameters:

LG-600SC

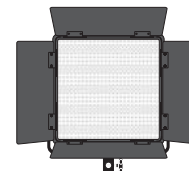

LED Bulbs Amount: 600 PCS
Total Power: 36W
AC Power: 100V-240V
DC Power: 15V
Color Temperature: 5600K/3200K
Filter: 1 SET

LG-900SC

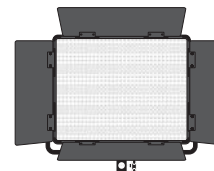

LED Bulbs Amount: 900 PCS
Total Power: 54W
AC Power: 100V-240V
DC Power: 15V
Color Temperature: 5600K/3200K
Filter: 1 SET

LG-1200SC

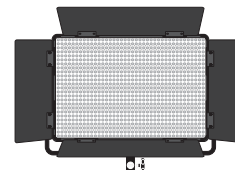

LED Bulbs Amount: 1200 PCS
Total Power: 72W
AC Power: 100V-240V
DC Power: 15V
Color Temperature: 5600K/3200K
Filter: 1 SET

Components:

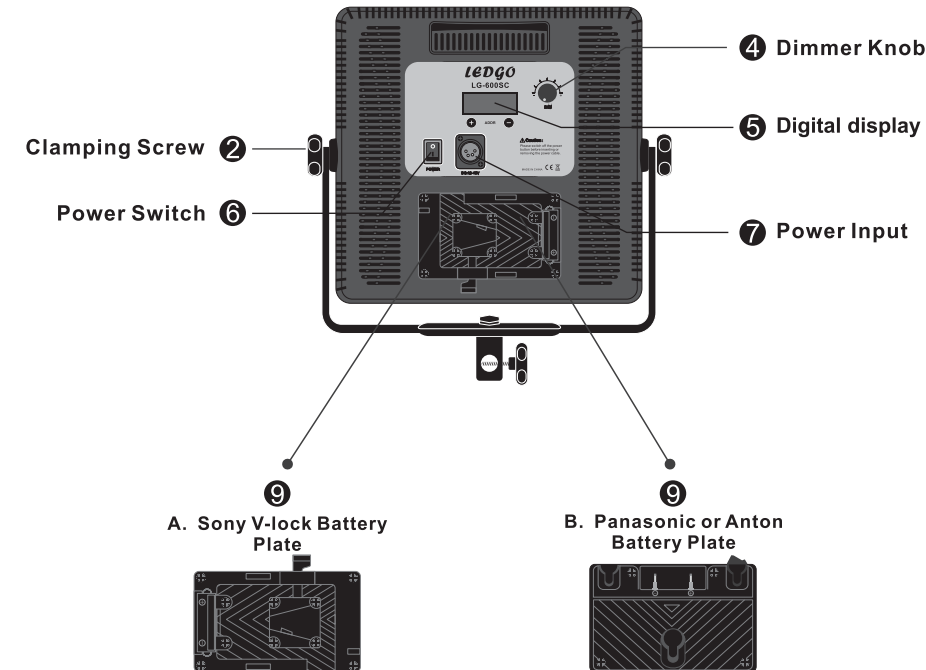
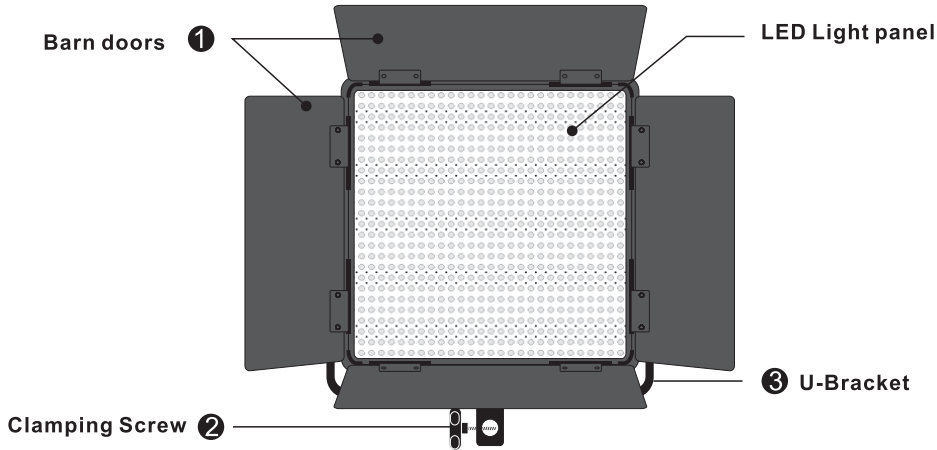

- 1 .Barn Doors:For better adjustment of light direction.
- 2 .Clamping Screws:To fix the light panel with U-bracket.
- 3 .U-bracket:To fix the light panel and adjust light direction.
- 4 .Dimmer Knob:For dimming,light can be dimmed to suit with different shooting conditions.
- 5 .Digital display: For displaying lighting brightness, and address code.
- 6 .Power Switch:To switch on or off.
- 7 .Power Input:For input of AC/DC power.
- 8 .Power Adapter:For connecting 100V-240V AC power to DC inverting and power stabilizing.
- 9 .Optional configuration:
 - A . Sony V-Lock Battery Plate: For mounting Sony V-Lock Batteries.
 - B . Panasonic or Anton Battery Plate: For mounting Panasonic or Anton Batteries.



8 Power Adapter

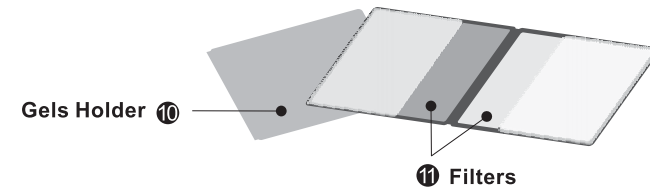

- 10 .Gels Holder:For packing the diffuser and filters.
- 11 .Diffuser and Filters: Without diffuser and filters, light is of spotlight effect and suitable for shooting at a relatively long distance; with diffuser, light is of soft light effect; with extra soft diffuser,light is of extra soft light effect; with 3200K filter, the color temperature of light changes from 5600K to 3200K (as below pictures).

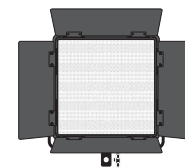

Without filter and diffuser

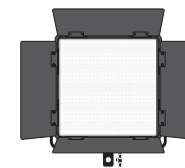

With diffuser

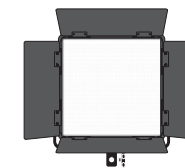

With extra soft diffuser

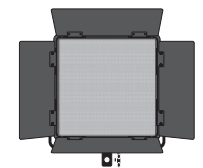

With 3200K filter