

MATCH PACK™

for Blackmagic

Pocket Cinema Camera 4K

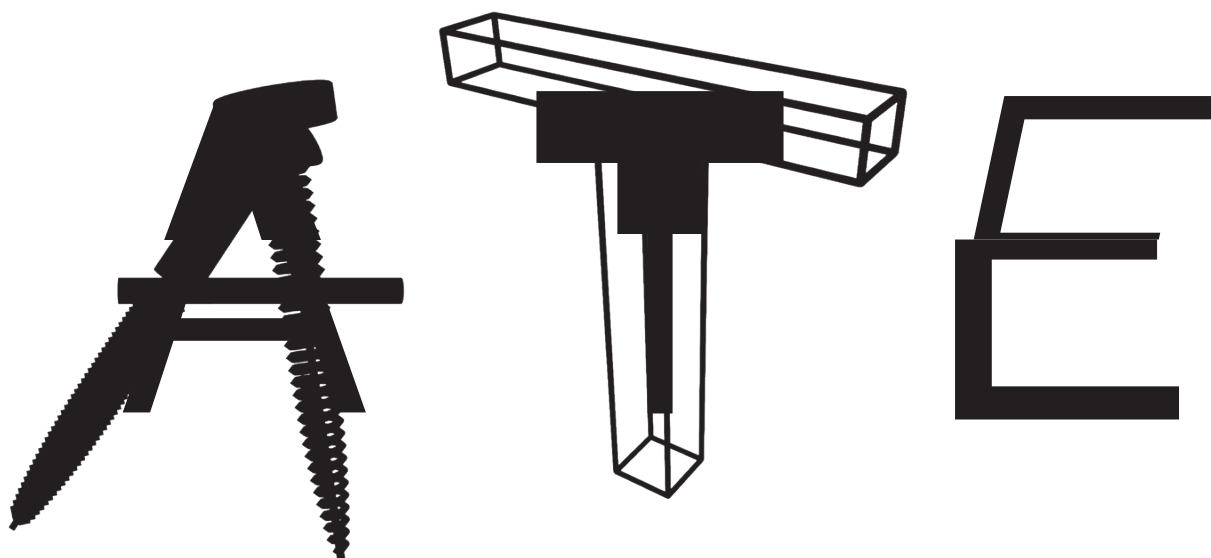
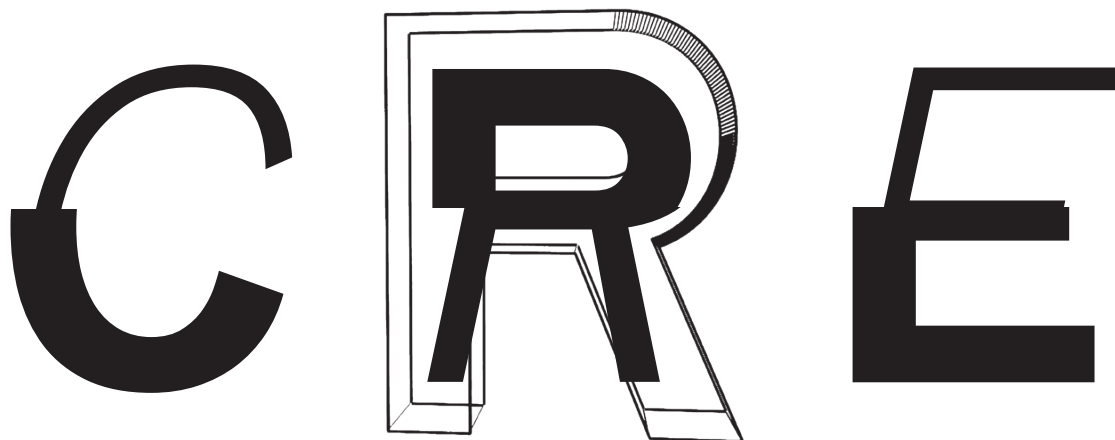

ANGELBIRD.COM

SPECIFICATIONS / ORDERING

SSD2GO PKT

GENERAL SPECIFICATIONS

Type
Ultra portable USB 3.1 Gen2 SSD drive

Capacity
SSD2GO PKT 512 GB

Connectivity
Thunderbolt 3 compatible, USB 3.1 Gen2, USB 3.1 Gen1, USB 3, USB 2
Type-A and Type-C

Dimensions
70.0 × 45.5 × 9.5 mm
(2.76 × 1.79 × 0.37 in)

Weight
~ 50.0g | ~ 1.8 oz

TECHNICAL SPECIFICATIONS

Flash
Grade A MLC NAND

Features
Overload protection, TRIM¹, ECC, EMS protection, SMART¹, ESD protection

PERFORMANCE SPECIFICATIONS

Sustained Read Speed²
up to 540 MB/s

Sustained Write Speed²
up to 480 MB/s

Sequential Read Speed²
up to 560 MB/s

Sequential Write Speed²
up to 500 MB/s

Access Time
~ 0.5 ms

MTBF
> 2,400,000 hours

Certifications
RoHS, CE, FCC

ENVIRONMENTAL SPECIFICATIONS

Operating Temperature
-20 °C ~ +70 °C

Storage Temperature
-40 °C ~ +85 °C

Operating Humidity
5% to 95% non-condensing

COLORS

 Graphite Grey

 Red

AV PRO CF

GENERAL SPECIFICATIONS

Capacity
1 × AV PRO CF 256 GB

Dimensions
42.8 × 36.4 × 3.3 mm
(1.69 × 1.43 × 0.13 in)

Form Factor
CFast

Weight
~ 10.0g

TECHNICAL SPECIFICATIONS

Interface
CFast 2.0 compliant

Over provisioning
~ 7.6 %

Features
Temperature sensor, TRIM¹, ECC, EMS protection, built-in cache, SMART¹

PERFORMANCE SPECIFICATIONS

Sustained Read Speed²
up to 550 MB/s

Sustained Write Speed²
up to 490 MB/s

Sequential Read Speed²
up to 560 MB/s

Sequential Write Speed²
up to 498 MB/s

RELIABILITY SPECIFICATIONS

MTBF
> 2,400,000 hours

Data Reliability
Built-in EDC / ECC function

Data Retention
10 years at 25 °C

Certifications
RoHS, CE, FCC

ELECTRICAL SPECIFICATIONS

DC input voltage
3.3V ± 5%

Power usage (idle/max)
0.37W / 2.22W

ENVIRONMENTAL SPECIFICATIONS

Shock resistance (operating)
50G

Vibration resistance (operating)
3.1G

Operating Temperature
-20 °C ~ +85 °C

Storage Temperature
-40 °C ~ +85 °C

Operating Humidity
5% to 95% non-condensing

SUPPORTED CODECS

Internal recording on CFast card supports Apple ProRes 422 HQ, ProRes 422, ProRes 422 LT, and H.264 for up to 4K at 60fps. H.265 internal recording supports up to 4K at 120fps.

SSD

MATCHPACK PCC4K

Specifications are subject to change without notice. Specifications are provided "as is" without warranty of any kind. 201907181313

SSD2GO PKT MOUNTING BRACKET



M
A
T
C
H
P
A
C
K

P
C
C
4
K

WE SEE YOU. YOU CLEVER LITTLE SEEKER OF VERSATILITY! WHEN YOU WANT TO RECORD CONTENT DIRECTLY FROM YOUR CAMERA TO YOUR SSD2GO PKT¹, WE'VE DESIGNED AN EQUALLY CLEVER LITTLE MOUNTING BRACKET TO SECURELY HOLD AND FASTEN YOUR SSD TO YOUR CAMERA'S HOT SHOE OR 1/4" RIG.

High Quality

Made from Aluminium, sturdy and durable

Lightweight

~52.0 g | ~1.83 oz.

Versatile

Dual mounting options allow a secure hold directly to camera's hot shoe or screw into 1/4" rig

ORDERING INFORMATION

 SKU	EAN	UPC
 PKTMB1	9120056584710	812937023539

Specifications are subject to change without notice.
Specifications are provided "as is" without warranty of any kind.

201907161313

USB TYPE A TO TYPE C ACTIVE ADAPTER



M
A
T
C
H
P
A
C
K

P
C
C
4
K

UP OR DOWN? IT DOESN'T MATTER. THE ADAPTER'S IMPLEMENTED ACTIVE SWITCHING LOGIC PROVIDES YOU WITH THE MOST OBVIOUS AND PRACTICAL ADVANTAGE OF ANY USB-C PLUG. IT CAN BE PLUGGED IN WHICHEVER WAY YOU WANT, UP OR DOWN. THUS, ALL OF THE ANNOYING FUMBLING, AS WITH CONVENTIONAL USB PLUGS, HAS BEEN ELIMINATED!



USB 3.1, Gen 2 10Gb/s
Type-A to Type-C



42 × 15 × 7.5 mm
(1.65 × 0.59 × 0.29 in)



Active switching logic



3-year limited warranty



UASP support



Mac | Windows | Linux | Android



TRIM support

ORDERING INFORMATION

SKU	EAN	UPC
USB-A-C	9120056583522	812937022341

SPECIFICATIONS / ORDERING

MATCH PACK PCC4K

CUSTOM BUILT FOR

Blackmagic Design
Pocket Cinema Camera 4K

WARRANTY³

3-year limited warranty

PACKAGE CONTENT

- 1× PKTU31-512PK | 1× AVP256CF
- Type-A to Type-C cable
- Type-C to Type-C cable
- SSD2GO PKT Mounting Bracket
- USB-A-C Adapter
- Activation code for the full limited warranty and additional free software licenses and content

RETAIL PACKAGING DETAILS

Box dimension

172 × 113 × 35 mm
(6.77 × 4.45 × 1.38 in)



Weight

~ 250.0g | ~ 8.8 oz.

- ¹ TRIM and SMART support depending on the OS used
- ² Speed based on internal testing. Actual transfer rates and capacity may vary depending on the product model, system hardware and other factors
- ³ To receive the full limited warranty, the product needs to be registered on the Angelbird Personal Service Portal within 30 days after purchase. If not registered within this period, the market-specific legal guarantee period comes into force.

Match Pack™ is a trademark of Angelbird Technologies GmbH. CFast® and Compact Flash® are registered trademarks of the Compact Flash Association. Blackmagic Design® is a registered trademark of Blackmagic Design Pty. Ltd. Other product names used herein are for identification purposes only and may be trademarks of their respective owners. Angelbird disclaims any and all rights in those marks.

ORDERING INFORMATION

 Capacity	SKU	EAN	UPC
 1× AVP256CF 1× PKT512GB	MP-PCC4K-512PK256C	9120056584369	812937023188
 1× AVP256CF 1× PKT512GB	MP-PCC4K-512EK256C	9120056584239	812937023058

SSD