

Arec

LS-110

Media Station



- 2 Video Sources Mixing, Switching, Recording and Live Streaming
- Easy to Create a Professional Video
- Fully Integrated with Kaltura, Panopto and Opencast Video Management Systems

Main Features

Easy to Create a Professional Video

AREC LS-110, a lightweight and all-in-one Media Station, supports 2 Full HD video sources capturing, switching, mixing, recording and live streaming simultaneously for non-technical users to produce a creative video easily and efficiently. With LS-110, it's easy to stream mixed video to up to 2 platforms at the same time, such as YouTube, Facebook, Twitch and other live broadcasting websites, allowing any participant to attend at any location in the world.

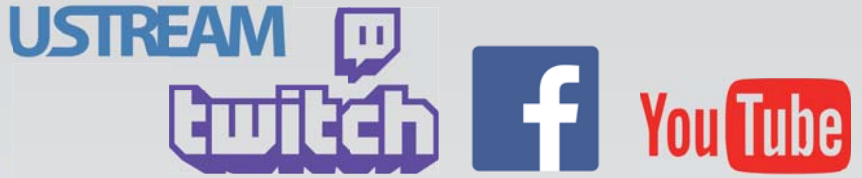

Capture Up to 2 Video Sources at the Same Time

Via HDMI, RJ-45 interfaces and streaming inputs, AREC LS-110 supports up to 2 Full HD 1080p video inputs. Users can choose 1 mixed video plus 2 individual videos recording for flexible use. LS-110 can mix audio via HDMI and 3.5mm stereo audio jack.

Mixed Recording

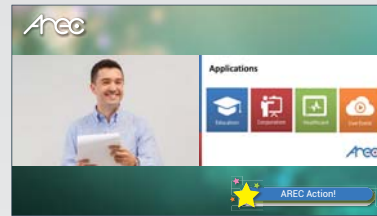

Original Sources

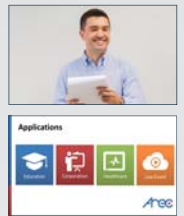

Adding Titles & Graphics to Your Video

With LS-110, users can easily switch and mix between sources, add or remove logos, backgrounds and overlay graphics (titles) to create your live video like a pro.

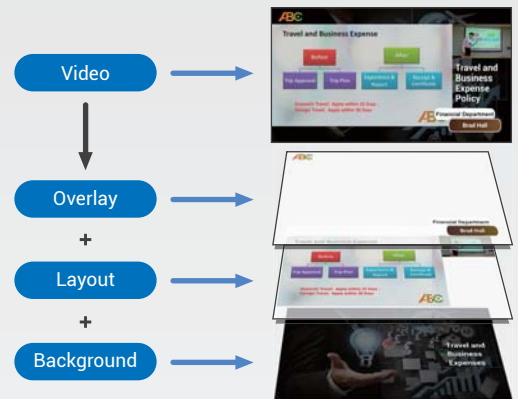

Intuitive and Versatile Control Options

AREC Online Director supports a wide range of control options, including Web Browser (IE, Firefox), Software Application (Windows, Mac OS), Touch-Friendly Graphical User Interface, and Mini Controller from Mobile Device. Control buttons on the front of LS-110 are also provided for easy operation.



On-screen GUI & USB Interface*



Web/ SW-based Online Director

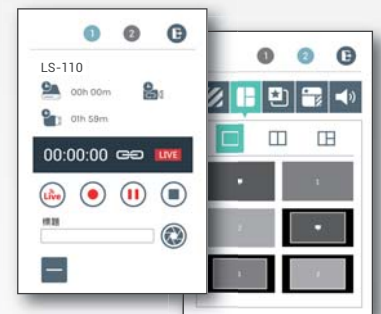

Mini Controller from Mobile Device

*The on-screen GUI supports mouse device control through USB connection.

AREC Video Manager: Videos with Just One Click

With the built-in Video Manager, administrators or teachers can manage videos stored in the local LS-110 Media Station remotely. They can download, upload or delete a video file, and edit video information. With available APIs, all of the video content, metadata, and thumbnail can be delivered seamlessly for third party integration.

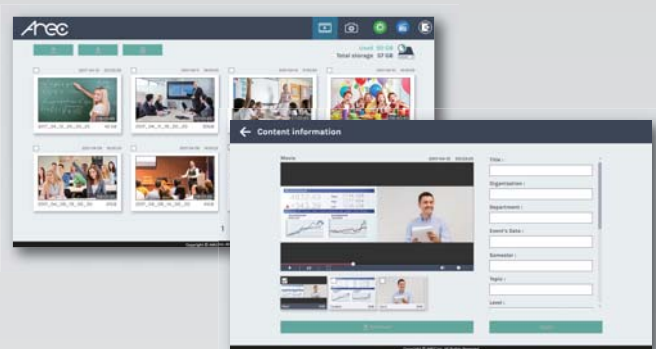

Recording and Backup

LS-110 can record and save video on the external USB storage through back port. After recording is done, LS-110 also supports automatic backup or upload recordings to AREC MediaCenter, FTP, SFTP, Opencast, Kaltura, Panopto and so on.



External Storage



OPENCAST Panopto KALTURA
FTP Backup



Product Interface

Front View

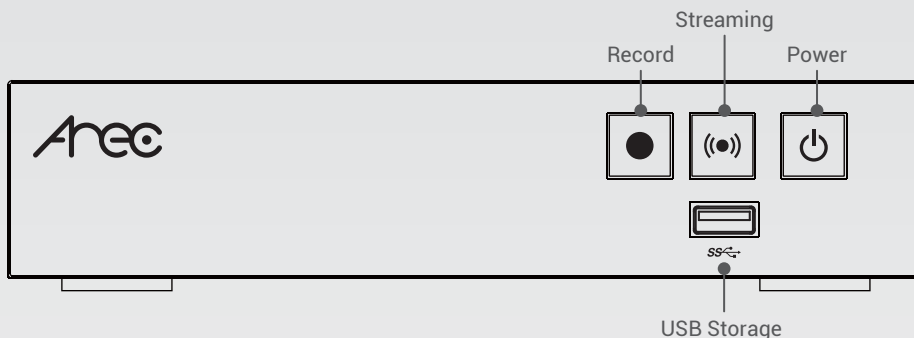

Back View

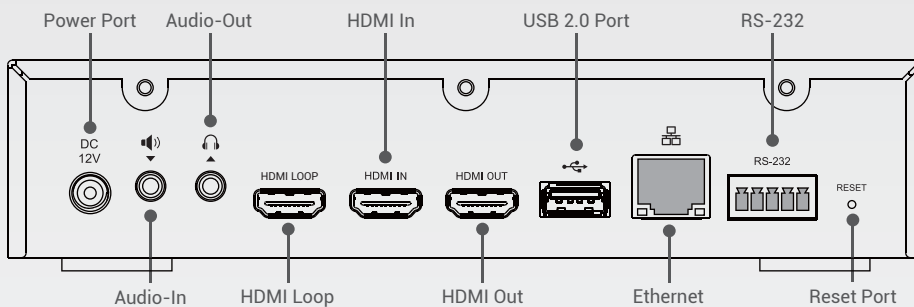

On-Screen Graphical User Interface



- 1 Overlay Images
- 2 Recording Layouts
- 3 Background
- 4 Custom Theme
- 5 Timer
- 6 Start / Stop Streaming
- 7 Start / Stop Recording
- 8 Snapshot
- 9 Playback Video
- 10 Setting
- 11 LS-110 IP Address
- 12 Audio Volumn Bar
- 13 Display Switch

Specifications

Model Name	AREC LS-110 Media Station
Video Inputs	
Video-in Interface	HDMI: 1 channel RJ-45: supports IP Streaming up to 2 channels
Max. Video-In channels	Maximum 2 channel synchronized recording HDMI: 1 channel Network camera: up to 2 channels
Resolution Range	HDMI: 480i~4Kp60 RTP/ RTMP/ RTSP, Max.: 1080p
Audio-in Channels	3.5mm Stereo Line in: 1 channel HDMI: 1 channel
Video Processing	
Compression	H.264 / AVC
Frame Rate	Max. 30fps
Bit Rate	300Kbps~8Mbps
Resolution	Max. 1080p (640x360 ~ 1920x1080)
Audio Processing	
Compression	AAC-LC
Bit Rate	80Kbps~320Kbps
Video / Audio Outputs	
Video Outputs	1x HDMI display ports (loop) 1x HDMI display ports (PGM with on-screen GUI) 2x H.264/AVC digital video over Ethernet
Audio Outputs	1x 3.5mm Stereo Line out 1x HDMI/1x HDMI Loop
Output Resolution	HDMI Loop:Max.4K HDMI:Max.1080p60
Streaming	
Streaming Delay	1 sec.
Compatible Streaming Input Protocols	RTSP, RTP, RTMP
Streaming Output Protocols	RTP, RTMP (RTMPS), RTSP Note: 1. users can choose 1 output option from RTP or RTMP only 2. RTP: MPEG2-TS over RTP unicast; MPEG2-TS over RTP multicast 3. RTSP (TCP/ UDP): Max 6 clients RTSP streams available via public URL (example: pulled streams)
Storage, Backup, and Compatibility	
External Storage	USB back port: supports 1 mixed and up to 2 individual original sources recording USB front port: supports 1 mixed recording/ 1 mixed and up to 2 individual video files backup
Locally Stored File Format	MP4
FTP Backup	Automatic backup to an FTP or SFTP server after recording is done
Third-Party Video Management System	Compatible with Opencast, Panopto and Kaltura

Recording	
Recording Modes	Mixed mode, 1 Mixed + 2 individual original sources
Recording Layouts	Multiple layouts for user-defined, including full screen/ picture-in-picture/ picture-by-picture
Bookmark	Automatic and manual bookmark insertion
Background Images	Multiple for user-defined
Overlay Images	Multiple for user-defined
Custom Themes	Multiple for user-defined, setting from web-based back stage
Live Broadcasting	
Live Broadcast to CDN or Stream Server	Yes, support RTMP (RTMPS) protocol. Stream up to 2 platforms simultaneously
Video Information Editing	
Post Video Info Editing	Yes, through Video Manager web page
Video Info Adding	Video info will be added on video file name automatically while file output or uploading
Controls of LS-110 and Network Camera	
Touch Interface	Through recommended touch screen, interactive projector or interactive module
Mouse Device and Numeric Keypad	Through USB interface connection
Mini Controller	Through mobile web browser and wireless connection for manual controls
External Control	Yes, supports RS-232 interface port
Control Buttons	Yes, recording/ streaming/ power
Video Manager Platform	Built-in Video Manager: through web-based control interface
Camera Control	VISCA / PELCO-D / PELCO-P / ONVIF profile S
General Information	
Operation System	Embedded Linux system
Power Supply	12V / 2A
Temperature / Humidity	0~40°C / 90%
Dimension	200mm(L) x 178mm(W) x 43mm(H)
Weight	1.37kg
Language	SC / TC / English/ Russian/ Spanish/ Czech/ Korean/ Latvian/ Estonian/ German
Accessories	Power adapter / quick guide

Recommended AREC Products



AREC Auto-Tracking System



AREC Network Cameras



AREC Wireless Microphone



AREC Wireless Audio Receiver



AREC Inc. | www.arec.com | sales@arec.com

Address: 3F, No. 367, Sec.2, Wenhua RD., Banqiao Dist., New Taipei City 220, Taiwan (R.O.C) TEL: +886-2-8259-5060

AREC reserves the right to modify product specifications without prior notice.